

DATA SHEET

TEA5711; TEA5711T AM/FM stereo radio circuit

Product specification
Supersedes data of October 1992
File under Integrated Circuits, IC01

September 1994

Philips Semiconductors



PHILIPS

AM/FM stereo radio circuit**TEA5711; TEA5711T****FEATURES**

- Wide supply voltage range: 1.8 or 2.1 to 12 V
- Low current consumption: 15 mA at AM, 16 mA at FM
- High selectivity with distributed IF gain
- LED driver for stereo indication
- High input sensitivity: 1.6 mV/m (AM), 2.0 μ V (FM) for 26 dB S/N
- Good strong signal behaviour: 10 V/m at AM, 500 mV at FM
- Low output distortion: 0.8% at AM, 0.3% at FM
- Signal level output
- Soft mute
- Signal dependent stereo

- Designed for simple and reliable printed-circuit board layout
- High impedance MOSFET input on AM.

APPLICATIONS

- Portable AM/FM stereo radio
- Mini/midi receiver sets
- Personal headphone radio.

DESCRIPTION

The TEA5711 is a high performance Bimos IC for use in AM/FM stereo radios. All necessary functions are integrated: from AM and FM front-end to AM detector and FM stereo output stages.

QUICK REFERENCE DATA

SYMBOL	PARAMETER	CONDITIONS	MIN.	TYP.	MAX.	TYP.
V_P	dynamic supply voltage		1.8	–	12	V
V_P	static supply voltage		2.1	–	12	V
I_P	supply current					
	AM mode		11.9	15.0	18.9	mA
	FM mode		13.5	16.5	20.2	mA
T_{amb}	operating ambient temperature		–15	–	+60	$^{\circ}$ C
AM performance						
V_{in1}	RF sensitivity		40	55	70	μ V
V_{28}	AF output voltage		36	45	70	mV
THD	total harmonic distortion		–	0.8	2.0	%
FM performance						
V_{in3}	RF sensitivity		1.0	2.0	3.8	μ V
V_{28}	AF output voltage		50	61	72	mV
THD	total harmonic distortion		–	0.3	0.8	%
MPX performance						
α_{CS}	channel separation		26	30	–	dB
A_{MPX}	MPX voltage gain	V_{AF-L}/V_{in9} ; S5 in position MONO	–1.5	0	+1.0	dB
THD	total harmonic distortion		–	0.5	1.0	%

ORDERING INFORMATION

TYPE NUMBER	PACKAGE		
	NAME	DESCRIPTION	VERSION
TEA5711	SDIP32	plastic shrink dual in-line package; 32 leads (400 mil)	SOT232-1
TEA5711T	SO32	plastic small outline package; 32 leads; body width 7.5 mm	SOT287-1

AM/FM stereo radio circuit

TEA5711; TEA5711T

BLOCK DIAGRAM

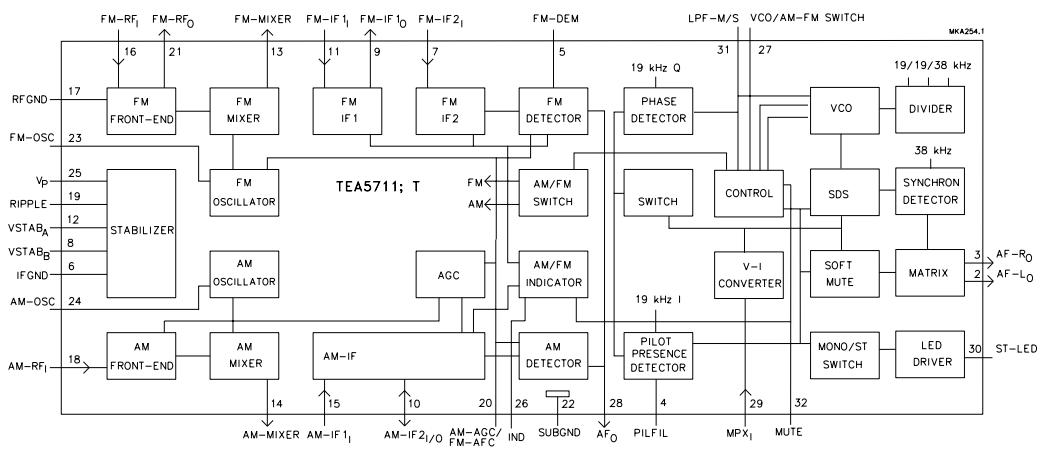

Fig.1 Block diagram.

AM/FM stereo radio circuit

TEA5711; TEA5711T

PINNING

SYMBOL	PIN	DESCRIPTION
n.c.	1	not connected
AF-L _O	2	left channel audio output (output impedance typ. 4.3 k Ω)
AF-R _O	3	right channel audio output (output impedance typ. 4.3 k Ω)
PILFIL	4	pilot detector filter pin
FM-DEM	5	ceramic discriminator pin
IFGND	6	ground of IF, detector and MPX stages
FM-IF _{2I}	7	second FM-IF input (input impedance typ. 330 Ω)
VSTAB _B	8	stabilized internal supply voltage (B)
FM-IF _{1O}	9	first FM-IF output (output impedance typ. 330 Ω)
AM-IF _{2I/O}	10	input/output to IFT; output: current source
FM-IF _{1I}	11	first FM-IF input (input impedance typ. 330 Ω)
VSTAB _A	12	stabilized internal supply voltage (A)
FM-MIXER	13	output to ceramic IF filter (output impedance typ. 330 Ω)
AM-MIXER	14	open-collector output to IFT
AM-IF _{1I}	15	input from IFT or ceramic filter (input impedance typ. 3 k Ω)
FM-RF _I	16	FM-RF aerial input (input impedance typ. 50 Ω)
RFGND	17	FM-RF ground
AM-RF _I	18	parallel tuned AM aerial circuit to ground (total input capacitance typ. 3 pF)
RIPPLE	19	ripple capacitor pin
AM-AGC/FM-AFC	20	AGC/AFC capacitor pin
FM-RF _O	21	parallel tuned FM-RF circuit to ground
SUBGND	22	substrate and RF ground
FM-OSC	23	parallel tuned FM-oscillator circuit to ground
AM-OSC	24	parallel tuned AM-oscillator circuit to ground
V _P	25	positive supply voltage
IND	26	signal level output
VCO/AM-FM SWITCH	27	VCO and switch terminal: open for AM; ground for FM
AF _O	28	AM/FM AF output (output impedance typ. 5 k Ω)
MPX _I	29	input for stereo decoder (input impedance typ. 180 k Ω)
ST-LED	30	stereo indicator
LPF-M/S	31	pin for loop-filter and mono/stereo switch
MUTE	32	mute pin

AM/FM stereo radio circuit

TEA5711; TEA5711T

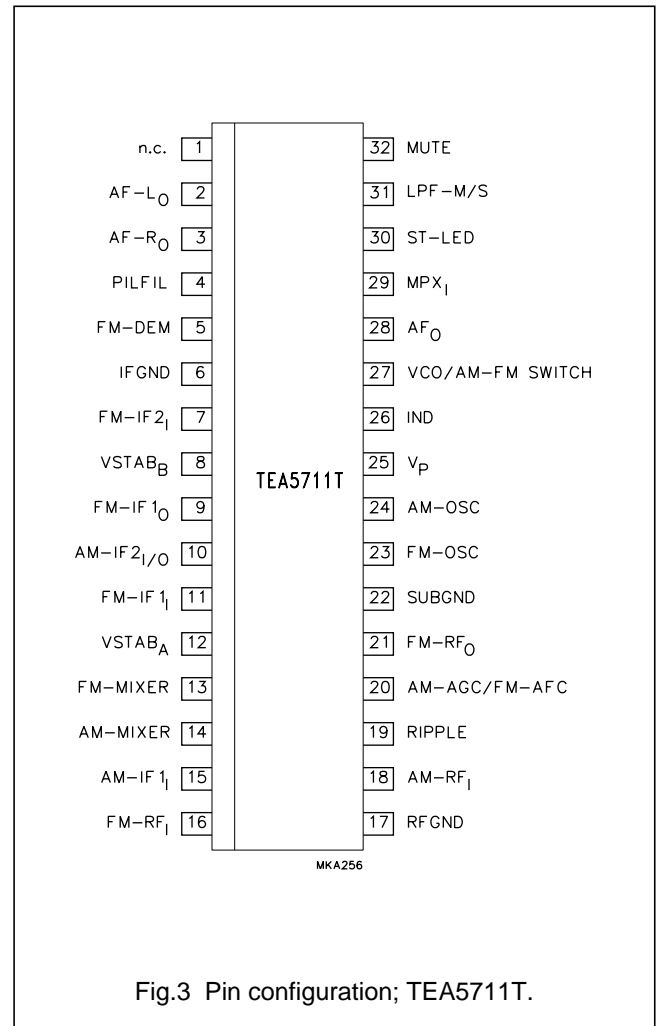
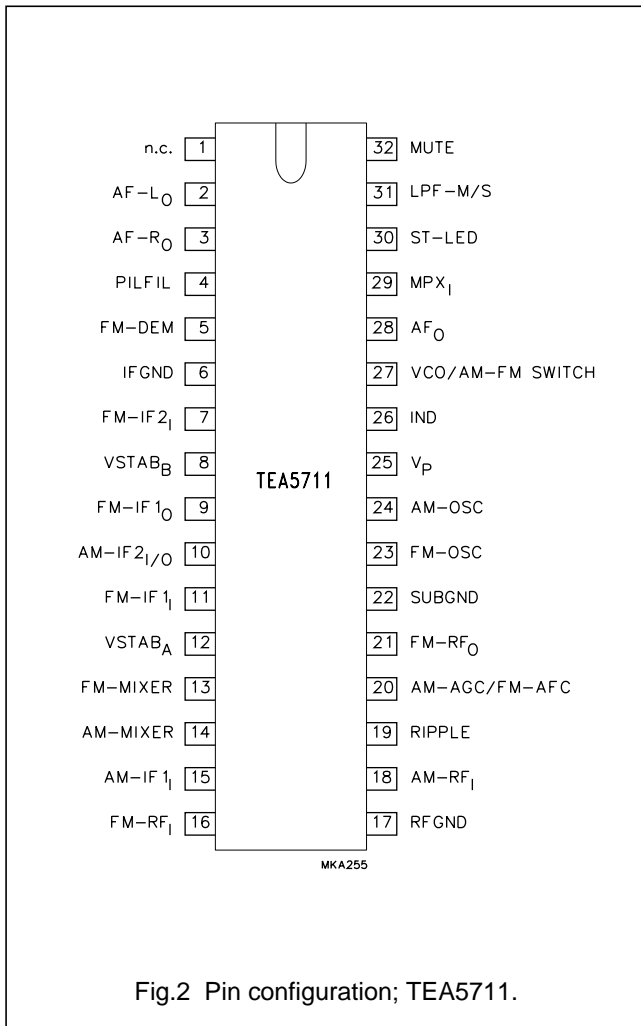

AM/FM stereo radio circuit

TEA5711; TEA5711T

FUNCTIONAL DESCRIPTION

The AM circuit incorporates a double balanced mixer, a one pin low-voltage oscillator (up to 30 MHz) a field-strength indicator output and is designed for distributed selectivity.

The AM input is designed to be connected to the top of a tuned circuit. AGC controls the IF amplification and for large signals it lowers the input impedance.

The first AM selectivity can be an IFT as well as an IFT combined with a ceramic filter; the second one is an IFT.

The FM circuit incorporates a tuned RF stage, a double balanced mixer, a one-pin oscillator, a field-strength indicator output and is designed for distributed IF ceramic filters. The FM quadrature detector uses a ceramic resonator.

The PLL stereo decoder incorporates a signal dependent stereo circuit, a soft-mute circuit and a stereo indicator LED driver.

Supply voltage behaviour

The TEA5711 incorporates internal stabilized power supplies. The maximum supply voltage is 12 V, the minimum voltage can go down temporarily to 1.8 V without any loss in performance.

Due to the capacitor at pin 19 (RIPPLE) the IC gives excellent performance, even when the actual supply voltage at pin 25 (V_P) drops below the voltage at pin 19 (RIPPLE).

Figures 4, 5 and 6 show that V_{stab} , which is dominant for the overall IC performance, remains unaffected, even if V_P drops down to 1.8 V or less. In this typical example the static or average V_P is equal to 2.5 V. Dips in V_{stab} appear only when the peak-to-peak value of the AC-component of $V_P > 2$ V, i.e. when the dynamic value of V_P drops down to 1.5 V for a short moment.

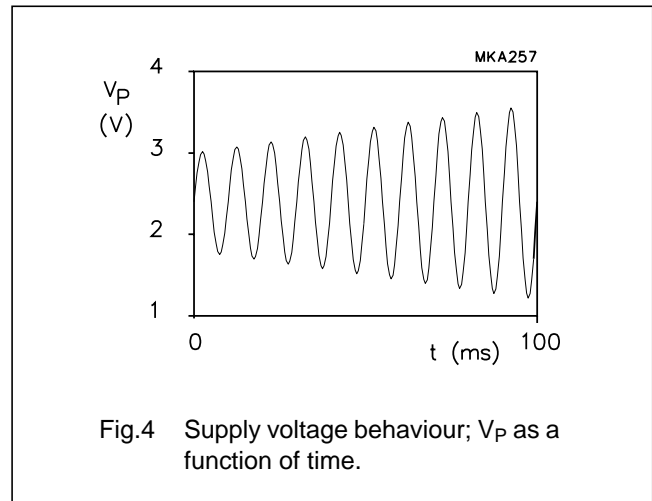

Fig.4 Supply voltage behaviour; V_P as a function of time.

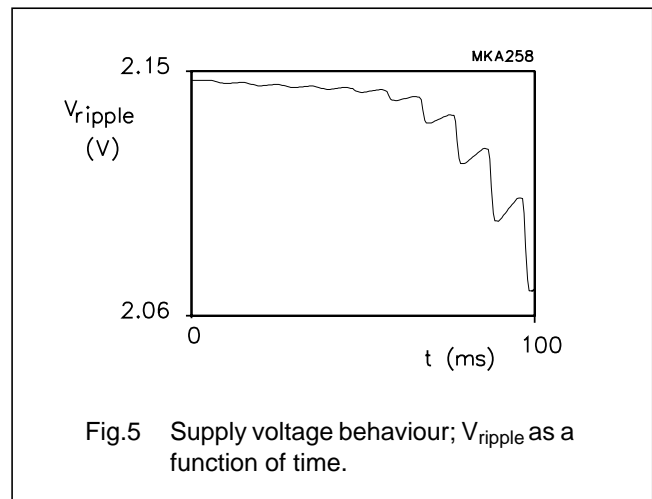

Fig.5 Supply voltage behaviour; V_{ripple} as a function of time.

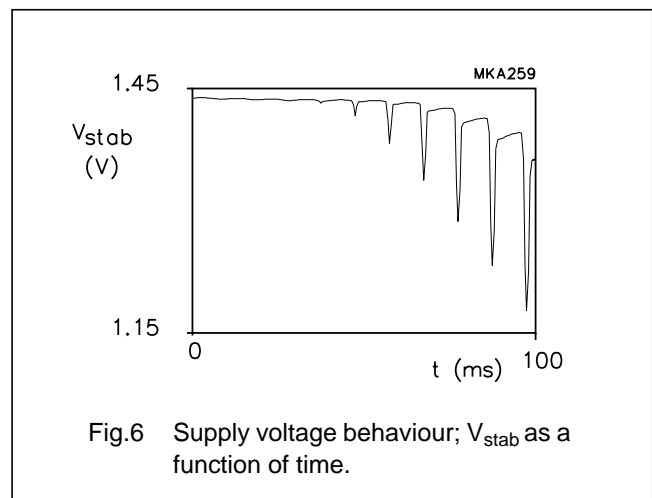

Fig.6 Supply voltage behaviour; V_{stab} as a function of time.

AM/FM stereo radio circuit

TEA5711; TEA5711T

LIMITING VALUES

In accordance with the Absolute Maximum Rating System (IEC 134).

SYMBOL	PARAMETER	MIN.	MAX.	UNIT
V_P	supply voltage	0	12	V
T_{stg}	storage temperature	-55	+150	°C
T_{amb}	operating ambient temperature	-15	+60	°C
T_j	junction temperature	-15	+150	°C

THERMAL CHARACTERISTICS

SYMBOL	PARAMETER	VALUE	UNIT
$R_{th\ j-a}$	thermal resistance from junction to ambient in free air		
	SDIP32	54	K/W
	SO32	68	K/W

AM/FM stereo radio circuit

TEA5711; TEA5711T

CIRCUIT DESIGN DATA

PIN NO.	PIN SYMBOL	DC PIN VOLTAGE (V)		EQUIVALENT CIRCUIT
		AM	FM	
1	n.c.	-	-	
2	AF-L _O output	0.65	0.65	
3	AF-R _O output	0.65	0.65	
4	PILFIL	0.95	0.95	
5	FM-DEM	-	1.0	
6	IFGND	0	0	

AM/FM stereo radio circuit

TEA5711; TEA5711T

PIN NO.	PIN SYMBOL	DC PIN VOLTAGE (V)		EQUIVALENT CIRCUIT
		AM	FM	
7	FM-IF2 _I input	-	0.73	
8	VSTAB _B	1.4	1.4	
9	FM-IF1 _O output	-	0.69	
10	AM-IF2 _{I/O} input/output	1.4	1.4	

AM/FM stereo radio circuit

TEA5711; TEA5711T

PIN NO.	PIN SYMBOL	DC PIN VOLTAGE (V)		EQUIVALENT CIRCUIT
		AM	FM	
11	FM-IF ₁ input	–	0.73	<p>MKA275.1</p>
12	VSTAB _A	1.4	1.4	<p>MKA276</p>
13	FM-MIXER output	–	1.0	<p>MKA277.1</p>
14	AM-MIXER output	1.4	1.4	<p>MKA278</p>

AM/FM stereo radio circuit

TEA5711; TEA5711T

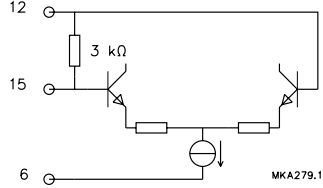
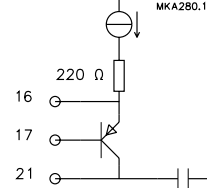
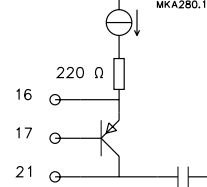
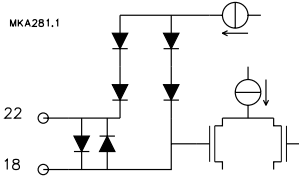
PIN NO.	PIN SYMBOL	DC PIN VOLTAGE (V)		EQUIVALENT CIRCUIT
		AM	FM	
15	AM-IF ₁ input	1.4	1.4	
16	FM-RF ₁ input	—	0.73	
17	RFGND	0	0	
18	AM-RF ₁ input	0	0	

AM/FM stereo radio circuit

TEA5711; TEA5711T

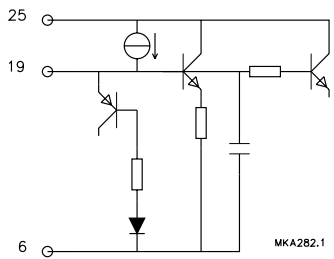
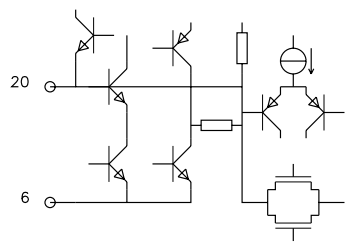
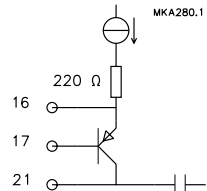
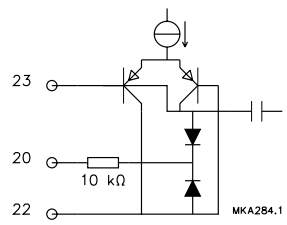
PIN NO.	PIN SYMBOL	DC PIN VOLTAGE (V)		EQUIVALENT CIRCUIT
		AM	FM	
19	RIPPLE	2.1	2.1	
20	AM-AGC/ FM-AFC	0.1	0.7	
21	FM-RF _O	0	0	
22	SUBGND	0	0	
23	FM-OSC	0	0	

AM/FM stereo radio circuit

TEA5711; TEA5711T

PIN NO.	PIN SYMBOL	DC PIN VOLTAGE (V)		EQUIVALENT CIRCUIT
		AM	FM	
24	AM-OSC	0	0	
25	V _P	3.0	3.0	
26	IND output	3.0	3.0	
27	VCO and AM/FM switch	1.3	0.95	
28	AF output	0.6	0.7	

AM/FM stereo radio circuit

TEA5711; TEA5711T

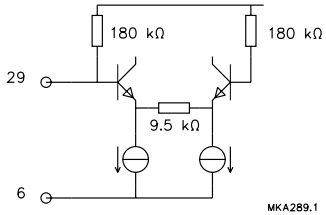
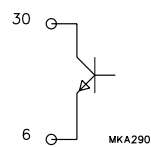
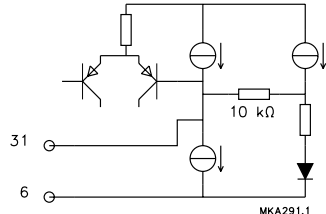
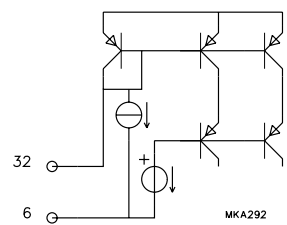
PIN NO.	PIN SYMBOL	DC PIN VOLTAGE (V)		EQUIVALENT CIRCUIT
		AM	FM	
29	MPX input	1.23	1.23	
30	ST-LED	3.0	3.0	
31	LPF-M/S	0.1	0.8	
32	MUTE	0.7	0.7	

AM/FM stereo radio circuit

TEA5711; TEA5711T

AM CHARACTERISTICS

$f_i = 1$ MHz; $m = 0.3$; $f_m = 1$ kHz; $V_P = 3.0$ V; measured in Fig.7 with S1 in position B, S2 in position A and S7 in position A; unless otherwise specified.

SYMBOL	PARAMETER	CONDITIONS	MIN.	TYP.	MAX.	UNIT
I_P	supply current	no input signal	11.9	15.0	18.9	mA
C_i	input capacitance	$V_{20} = 0.2$ V	–	3	–	pF
G_c	front-end conversion gain	$V_{20} = 0.2$ V	1.8	3.3	5.0	
V_{in1}	RF sensitivity	S/N = 26 dB	40	55	70	μ V
V_{in2}	IF sensitivity	$V_{28} = 30$ mV; S1 in position A	0.13	0.2	0.45	mV
V_{28}	AF output voltage	$V_{in2} = 3.16$ mV; S1 in position A	36	45	70	mV
THD	total harmonic distortion	$V_{in1} = 1$ mV	–	0.8	2.0	%
V_{in1}	large signal handling	$m = 0.8$; THD $\leq 8\%$	150	300	–	mV
I_{IND}	indicator current	$V_{in2} = 100$ mV; S1 in position A	120	170	230	μ A
I_{INDOFF}	indicator OFF current	$V_{in2} = 0$ V; S1 in position A	–	0	10	μ A

FM CHARACTERISTICS

$f_i = 100$ MHz; $\Delta f = 22.5$ kHz; $f_m = 1$ kHz; $V_P = 3.0$ V; measured in Fig.7 with S1 in position B, S2 in position A and S7 in position A; unless otherwise specified.

SYMBOL	PARAMETER	CONDITIONS	MIN.	TYP.	MAX.	UNIT
I_P	supply current	no input signal	13.5	16.5	20.2	mA
V_{in3}	RF limiting sensitivity	$V_{28} = -3$ dB	0.4	1.2	3.8	μ V
V_{in3}	RF sensitivity	S/N = 26 dB	1.0	2.0	3.8	μ V
V_{11}/V_{in3}	front-end voltage gain	$V_{in3} \leq 1$ mV; including ceramic filter K1	12	18	22	dB
V_{in4}	IF sensitivity	S2 in position B; $V_{28} = -3$ dB	–	20	30	μ V
V_{28}	AF output voltage	$V_{in3} = 1$ mV	50	61	72	mV
THD	total harmonic distortion	$V_{in3} = 1$ mV; $\Delta f = 22.5$ kHz	–	0.3	0.8	%
V_{in3}	large signal handling	THD $\leq 5\%$	–	500	–	mV
I_{IND}	indicator current	$V_{in4} = 100$ mV; S2 in position B	190	255	320	μ A
I_{INDOFF}	indicator OFF current	$V_{in4} = 0$ V; S2 in position B	–	0	2	μ A

STEREO DECODER CHARACTERISTICS

$f_i = 1$ kHz; $V_{in9(L+R)} = 195$ mV; pilot = 20 mV; $V_P = 3.0$ V; measured in Fig.7 with S1 in position B, S2 in position A, S6 in position A, S7 in position A and S5 in position STEREO; unless otherwise specified.

SYMBOL	PARAMETER	CONDITIONS	MIN.	TYP.	MAX.	UNIT
A_{MPX}	MPX voltage gain V_{AF-L}/V_{in9}	S5 in position MONO	-1.5	0	+1.0	dB
THD	total harmonic distortion		–	0.5	1.0	%
(S+N)/N	signal plus noise-to-noise ratio	pilot = 20 mV	–	74	–	dB
α_{cs}	channel separation	L = 1; R = 0 or L = 0; R = 1	26	30	–	dB
SC	stereo control	$V_{in3} = 120$ μ V	–	30	–	dB
		$V_{in3} = 10$ μ V	–	1	–	dB
α_{MUTE}	AF output signal suppression	$V_{in3} \leq 2$ μ V	–	20	–	dB

AM/FM stereo radio circuit

TEA5711; TEA5711T

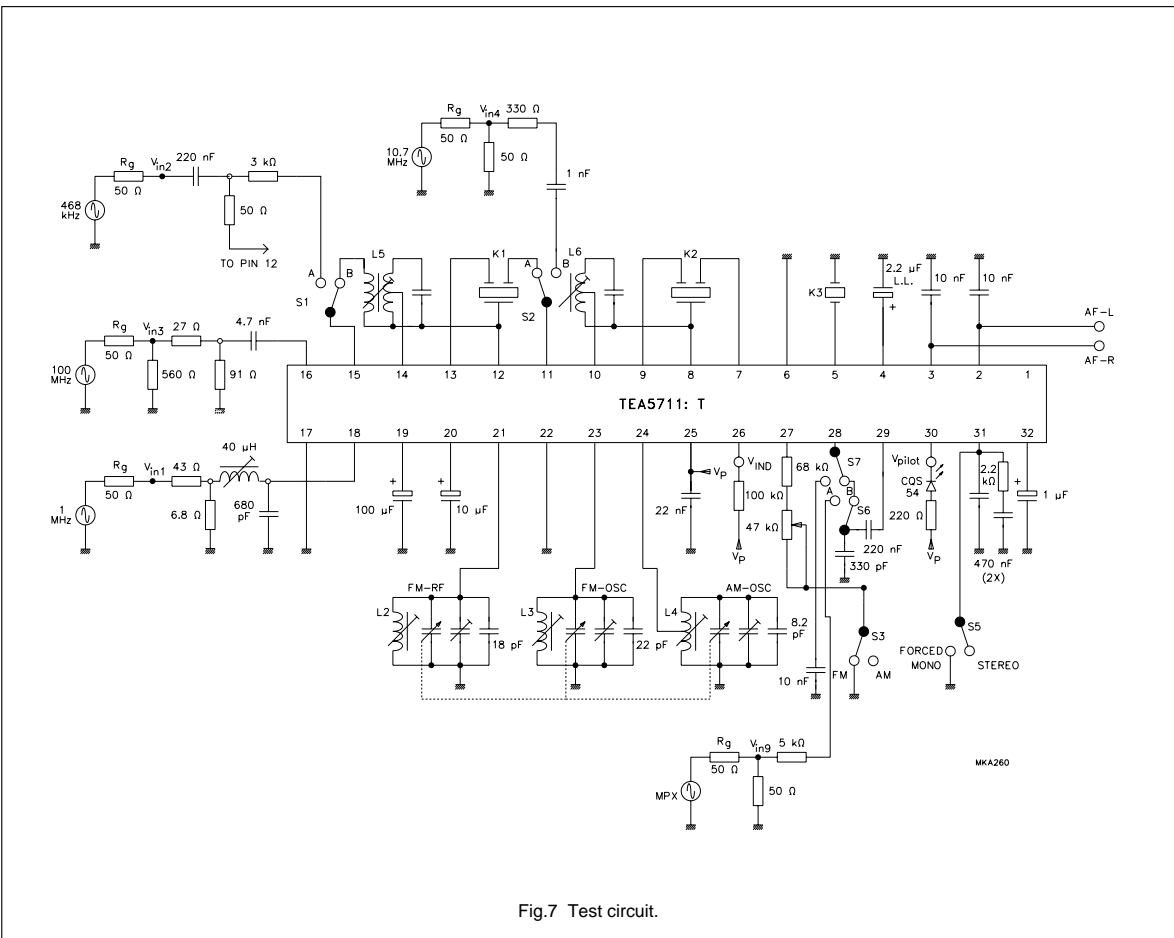

Fig.7 Test circuit.

AM/FM stereo radio circuit

TEA5711; TEA5711T

APPLICATION INFORMATION

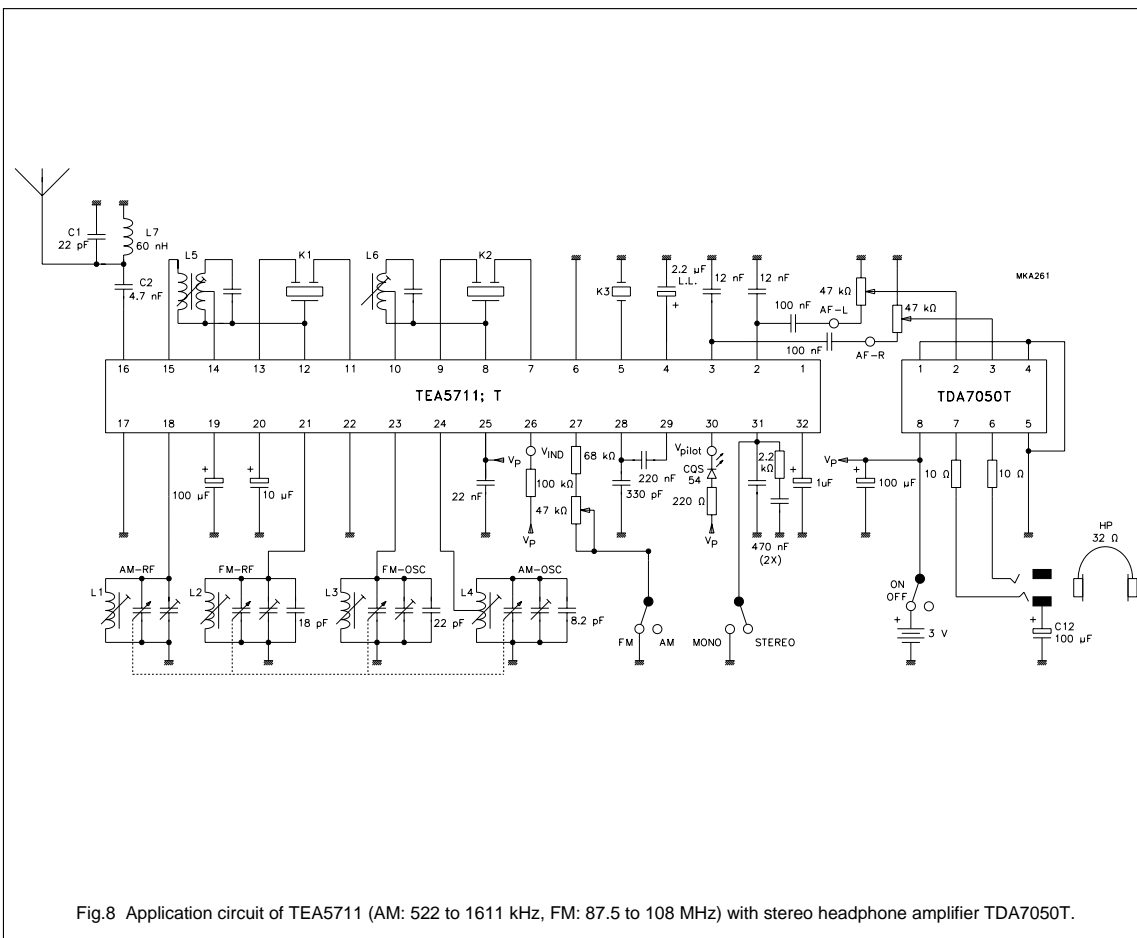

Fig.8 Application circuit of TEA5711 (AM: 522 to 1611 kHz, FM: 87.5 to 108 MHz) with stereo headphone amplifier TDA7050T.

AM/FM stereo radio circuit

TEA5711; TEA5711T

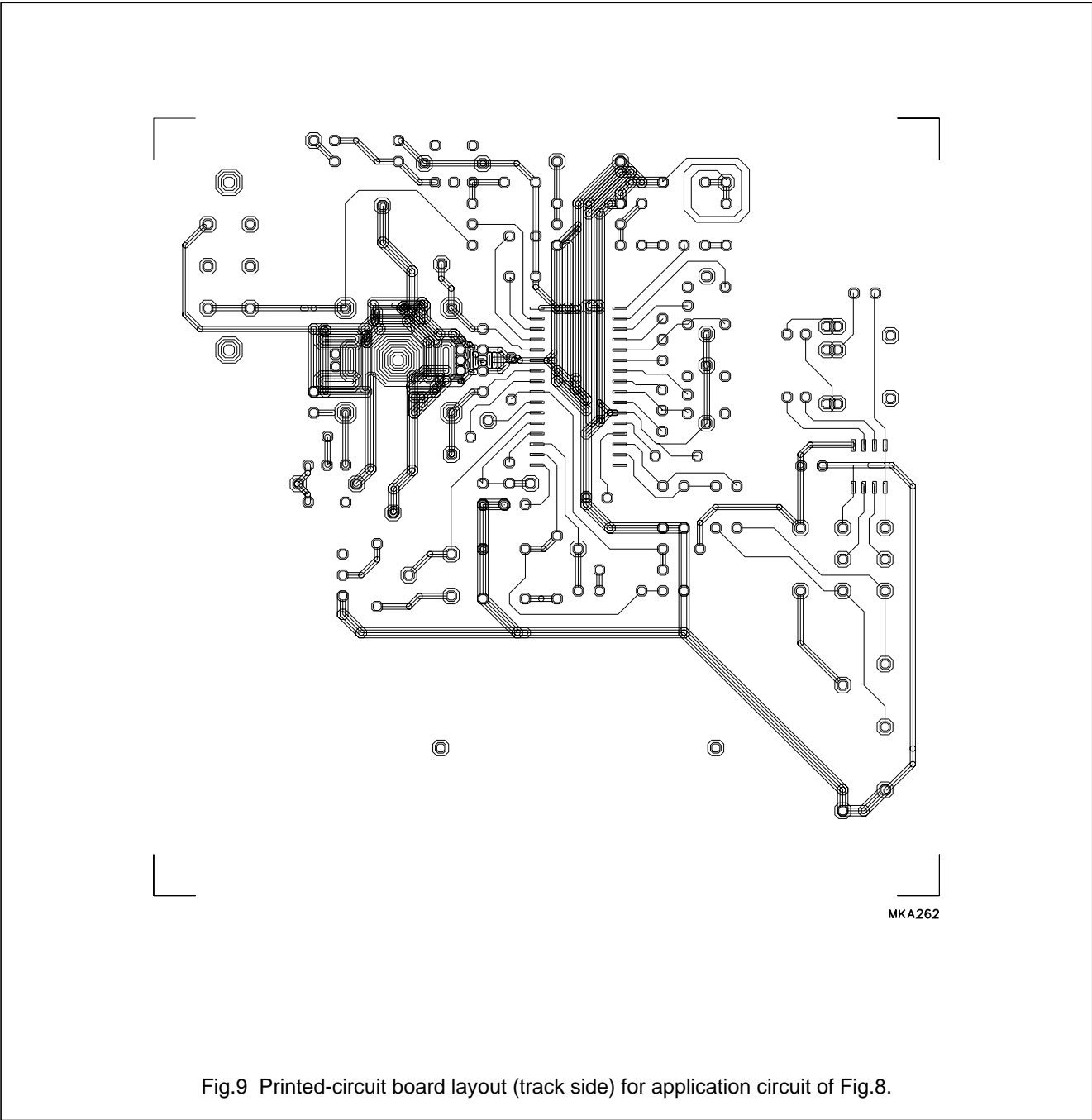

Fig.9 Printed-circuit board layout (track side) for application circuit of Fig.8.

AM/FM stereo radio circuit

TEA5711; TEA5711T

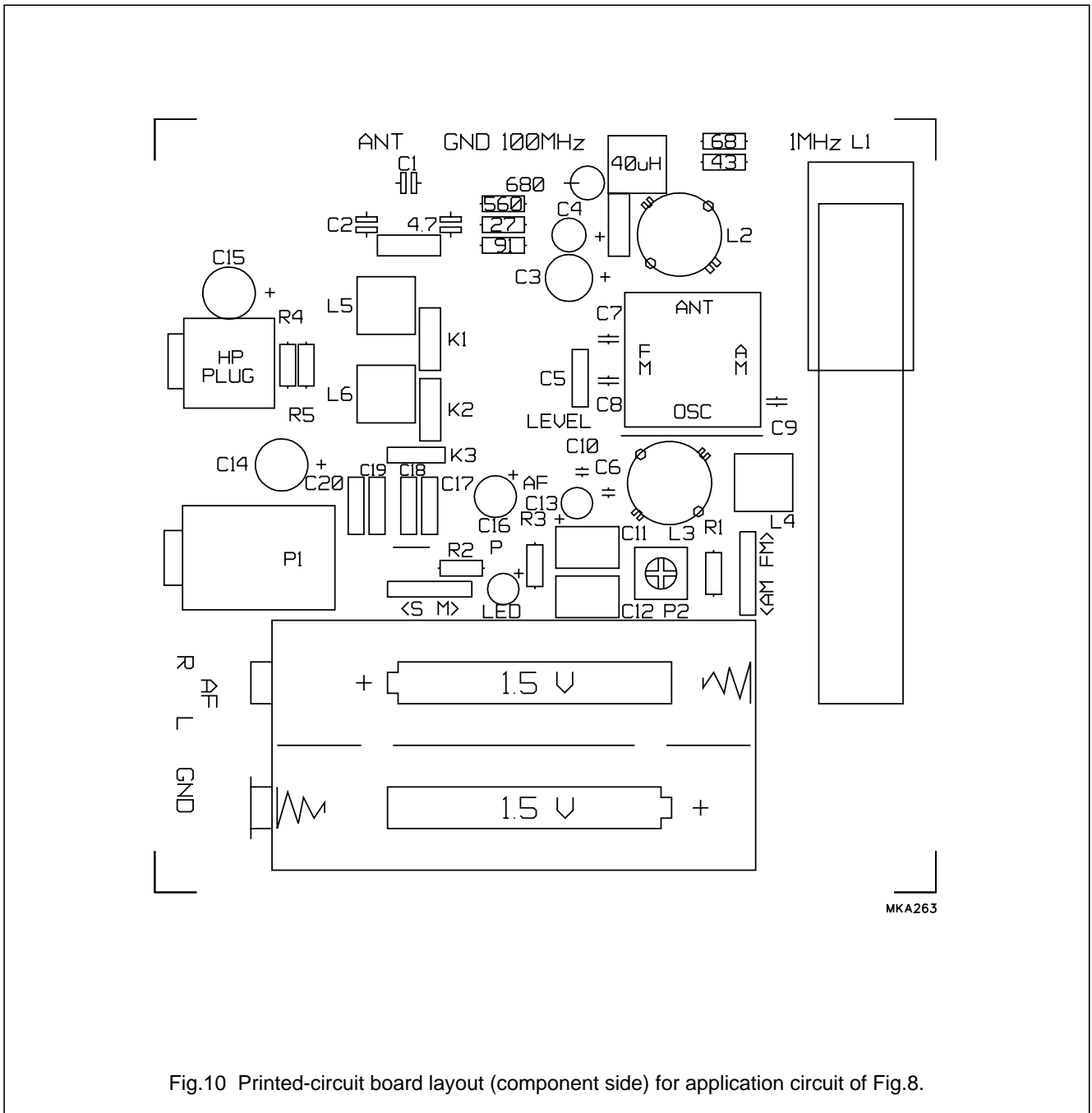

Fig.10 Printed-circuit board layout (component side) for application circuit of Fig.8.

AM/FM stereo radio circuit

TEA5711; TEA5711T

Components for Figs 7 and 8

NUMBER	TYPE	DESCRIPTION	CIRCUIT
Coils			
L1	AM-AERIAL	ferroceptor length = 6 cm L1-2 = 625 μ H N1-2 = 105 turns unloaded Q	
L2	FM-RF	L1-2 = 66 nH N1-2 = 2.5 turns unloaded Q = 150T TOKO type S18 TOKO number 301SS-0200	
L3	FM-OSC	L1-2 = 40 nH N1-2 = 1.5 turns unloaded Q = 150 TOKO type S18 TOKO number 301SS-0100	
L4	AM-OSC	L1-3 = 270 μ H N1-2 = 18 N2-3 = 70 unloaded Q = 100 wire diameter 0.07 mm TOKO type 7P material TOKO 7BRS	
L5	AM-IF1	L1-3 = 625 μ H N1-2 = 17 turns N2-3 = 141 turns N4-6 = 10 turns C1-3 = 180 pF unloaded Q = 90 wire diameter 0.07 mm TOKO type 7P material TOKO 7MCS	
L6	AM-IF2	L1-3 = 625 μ H N1-2 = 28 turns N2-3 = 130 turns C1-3 = 180 pF unloaded Q = 90 wire diameter 0.07 mm TOKO type 7P material TOKO 7MCS	
L7	FM-AERIAL	printcoil L1-2 = 60 nH N1-2 = 2.5 turns	

AM/FM stereo radio circuit

TEA5711; TEA5711T

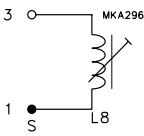
NUMBER	TYPE	DESCRIPTION	CIRCUIT
L8	AM-RF	test circuit only: L1-3 = 40 μ H N1-3 = 34 turns unloaded Q = 85 wire diameter 0.09 mm TOKO type 7P material TOKO 7BRS	
Ceramic filters			
K1	FM-IF1	Murata SFE 10.7 MS 2	
K2	FM-IF2	Murata SFE 10.7 MS 2	
K3	FM-DET	Murata CDA 10.7 MC 40	
Capacitors			
C1	VARICON	AM: 140/82 pF FM: 2 \times 20 pF trimmer: 4 \times 8 pF TOKO type number HU-22124	

Application remarks

- Short circuiting: **all** pins are short-circuit proof except **pin 16** (FM-RF₁) with respect to the supply voltage pin.
- For an example of printed-circuit board layout: see Figs 9 and 10.
- Align VCO with aerial signal present.

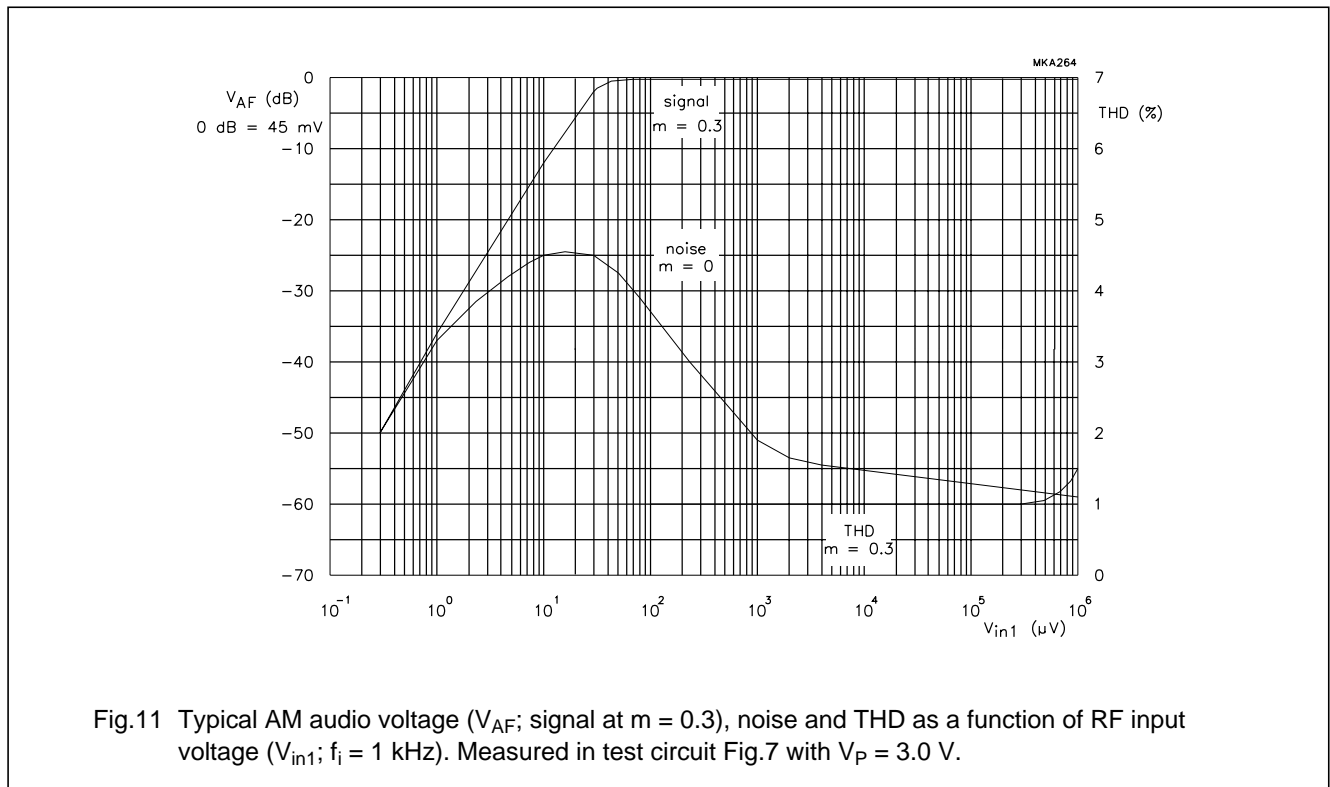

Fig.11 Typical AM audio voltage (V_{AF} ; signal at $m = 0.3$), noise and THD as a function of RF input voltage (V_{in1} ; $f_i = 1$ kHz). Measured in test circuit Fig.7 with $V_P = 3.0$ V.

AM/FM stereo radio circuit

TEA5711; TEA5711T

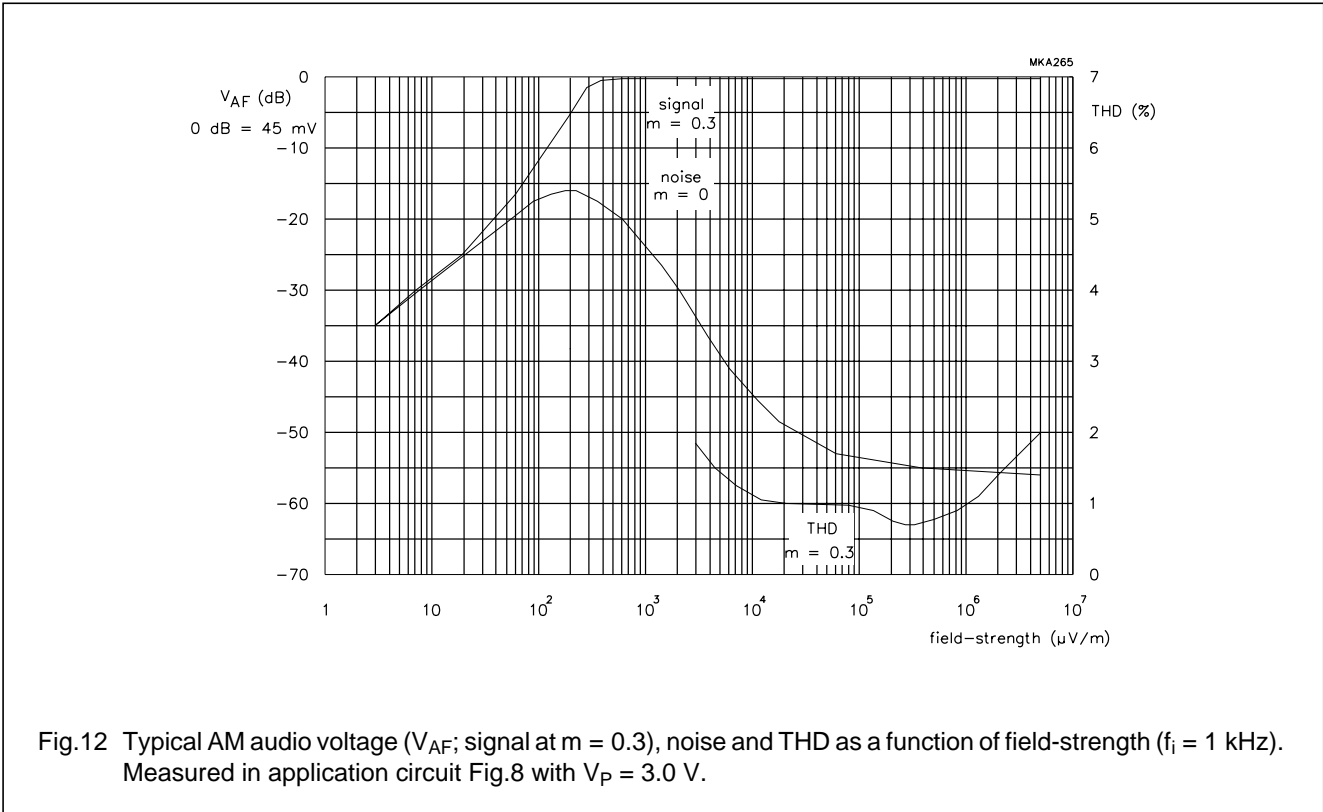

Fig. 12 Typical AM audio voltage (V_{AF} ; signal at $m = 0.3$), noise and THD as a function of field-strength ($f_i = 1$ kHz). Measured in application circuit Fig.8 with $V_P = 3.0$ V.

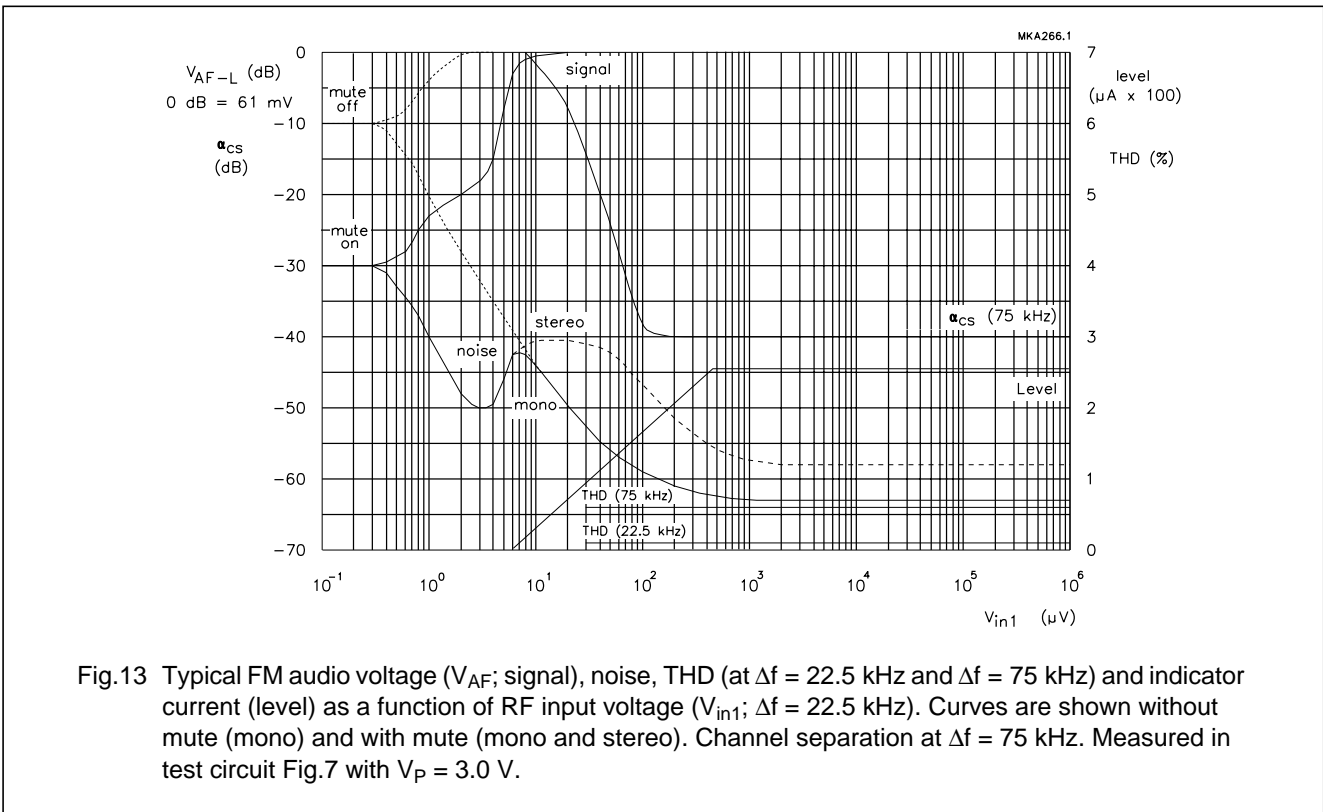
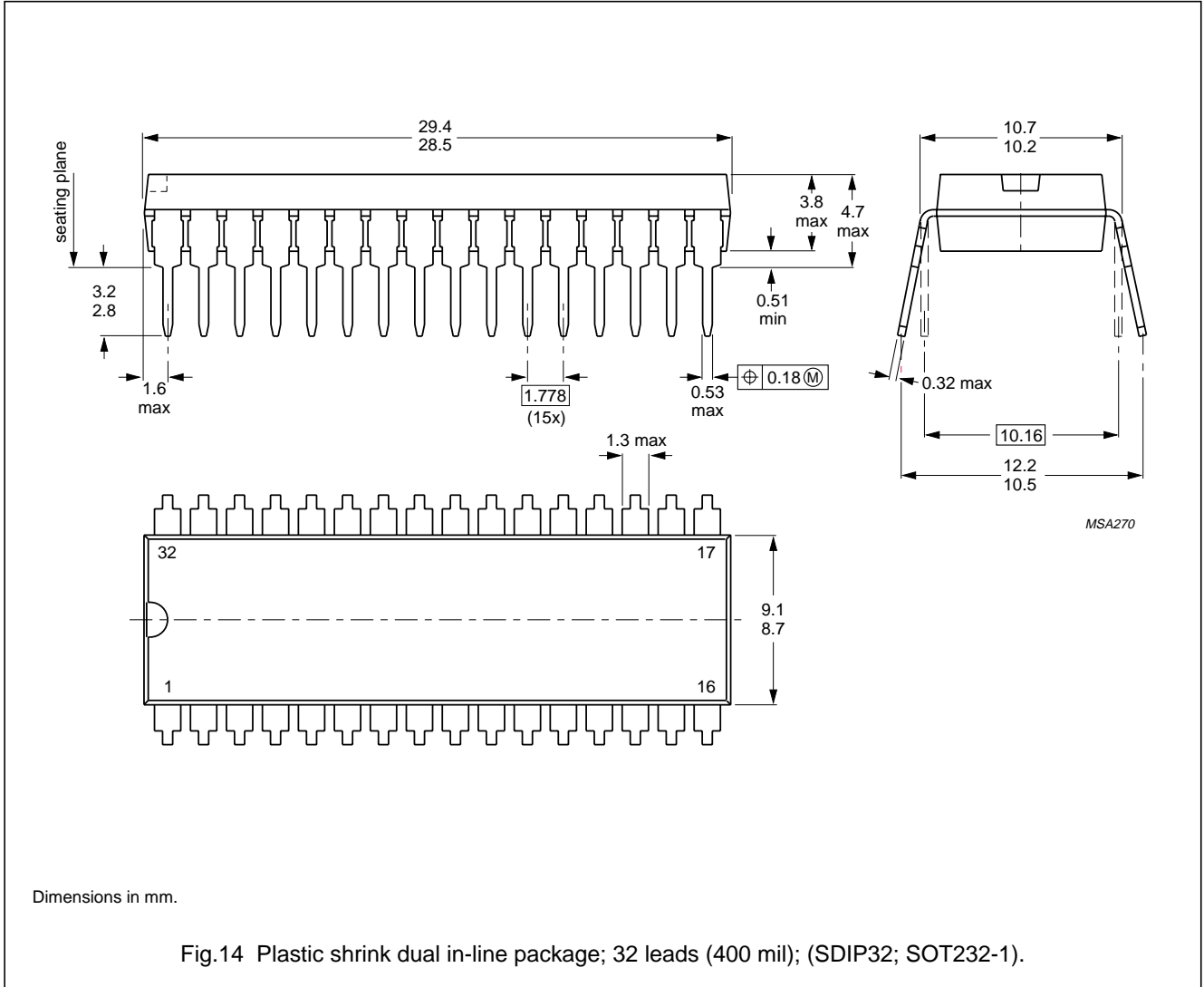

Fig. 13 Typical FM audio voltage (V_{AF} ; signal), noise, THD (at $\Delta f = 22.5$ kHz and $\Delta f = 75$ kHz) and indicator current (level) as a function of RF input voltage (V_{in1} ; $\Delta f = 22.5$ kHz). Curves are shown without mute (mono) and with mute (mono and stereo). Channel separation at $\Delta f = 75$ kHz. Measured in test circuit Fig.7 with $V_P = 3.0$ V.

AM/FM stereo radio circuit

TEA5711; TEA5711T

PACKAGE OUTLINES



AM/FM stereo radio circuit

TEA5711; TEA5711T

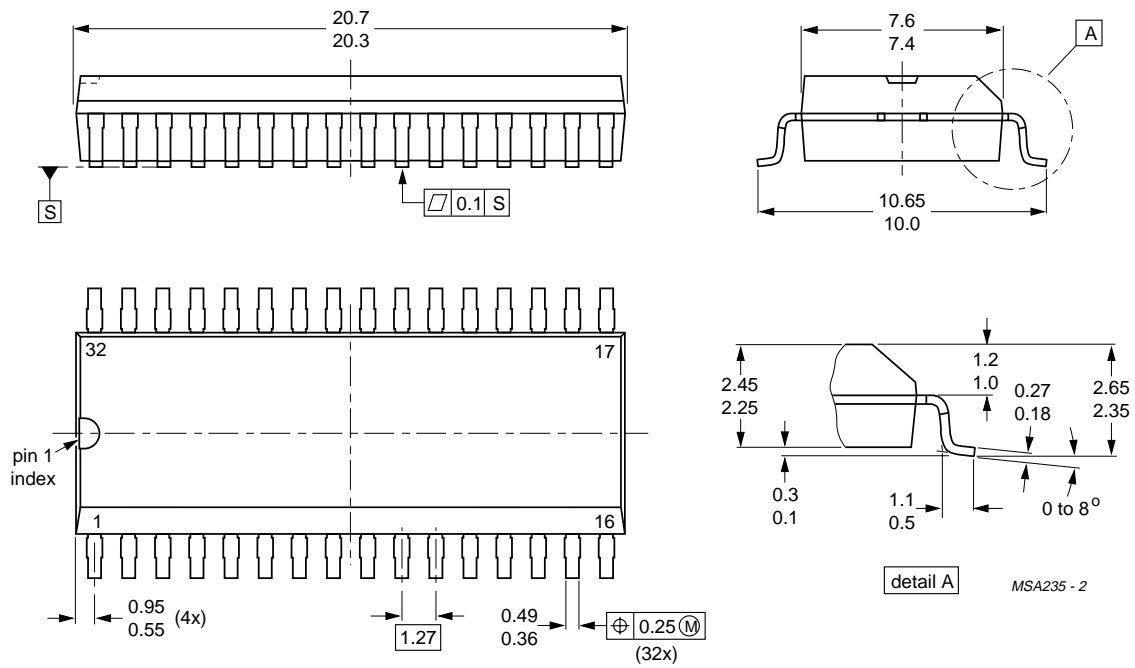

Dimensions in mm.

Fig.15 Plastic small outline package; 32 leads; body width 7.5 mm (SO32; SOT287-1).

AM/FM stereo radio circuit**TEA5711; TEA5711T**

SOLDERING**Plastic dual in-line packages**

BY DIP OR WAVE

The maximum permissible temperature of the solder is 260 °C; this temperature must not be in contact with the joint for more than 5 s. The total contact time of successive solder waves must not exceed 5 s.

The device may be mounted up to the seating plane, but the temperature of the plastic body must not exceed the specified storage maximum. If the printed-circuit board has been pre-heated, forced cooling may be necessary immediately after soldering to keep the temperature within the permissible limit.

REPAIRING SOLDERED JOINTS

Apply the soldering iron below the seating plane (or not more than 2 mm above it). If its temperature is below 300 °C, it must not be in contact for more than 10 s; if between 300 and 400 °C, for not more than 5 s.

Plastic small-outline packages

BY WAVE

During placement and before soldering, the component must be fixed with a droplet of adhesive. After curing the adhesive, the component can be soldered. The adhesive can be applied by screen printing, pin transfer or syringe dispensing.

Maximum permissible solder temperature is 260 °C, and maximum duration of package immersion in solder bath is 10 s, if allowed to cool to less than 150 °C within 6 s. Typical dwell time is 4 s at 250 °C.

A modified wave soldering technique is recommended using two solder waves (dual-wave), in which a turbulent wave with high upward pressure is followed by a smooth laminar wave. Using a mildly-activated flux eliminates the need for removal of corrosive residues in most applications.

BY SOLDER PASTE REFLOW

Reflow soldering requires the solder paste (a suspension of fine solder particles, flux and binding agent) to be applied to the substrate by screen printing, stencilling or pressure-syringe dispensing before device placement.

Several techniques exist for reflowing; for example, thermal conduction by heated belt, infrared, and vapour-phase reflow. Dwell times vary between 50 and 300 s according to method. Typical reflow temperatures range from 215 to 250 °C.

Preheating is necessary to dry the paste and evaporate the binding agent. Preheating duration: 45 min. at 45 °C.

REPAIRING SOLDERED JOINTS (BY HAND-HELD SOLDERING IRON OR PULSE-HEATED SOLDER TOOL)

Fix the component by first soldering two, diagonally opposite, end pins. Apply the heating tool to the flat part of the pin only. Contact time must be limited to 10 s at up to 300 °C. When using proper tools, all other pins can be soldered in one operation within 2 to 5 s at between 270 and 320 °C. (Pulse-heated soldering is not recommended for SO packages.)

For pulse-heated solder tool (resistance) soldering of VSO packages, solder is applied to the substrate by dipping or by an extra thick tin/lead plating before package placement.

AM/FM stereo radio circuit

TEA5711; TEA5711T

DEFINITIONS

Data sheet status	
Objective specification	This data sheet contains target or goal specifications for product development.
Preliminary specification	This data sheet contains preliminary data; supplementary data may be published later.
Product specification	This data sheet contains final product specifications.
Limiting values	
Limiting values given are in accordance with the Absolute Maximum Rating System (IEC 134). Stress above one or more of the limiting values may cause permanent damage to the device. These are stress ratings only and operation of the device at these or at any other conditions above those given in the Characteristics sections of the specification is not implied. Exposure to limiting values for extended periods may affect device reliability.	
Application information	
Where application information is given, it is advisory and does not form part of the specification.	

LIFE SUPPORT APPLICATIONS

These products are not designed for use in life support appliances, devices, or systems where malfunction of these products can reasonably be expected to result in personal injury. Philips customers using or selling these products for use in such applications do so at their own risk and agree to fully indemnify Philips for any damages resulting from such improper use or sale.

AM/FM stereo radio circuit

TEA5711; TEA5711T

NOTES

Philips Semiconductors – a worldwide company

Argentina: IEROD, Av. Juramento 1992 - 14.b, (1428)
BUENOS AIRES, Tel. (541)786 7633, Fax. (541)786 9367

Australia: 34 Waterloo Road, NORTH RYDE, NSW 2113,
Tel. (02)805 4455, Fax. (02)805 4466

Austria: Triester Str. 64, A-1101 WIEN, P.O. Box 213,
Tel. (01)60 101-1236, Fax. (01)60 101-1211

Belgium: Postbus 90050, 5600 PB EINDHOVEN, The Netherlands,
Tel. (31)40 783 749, Fax. (31)40 788 399

Brazil: Rua do Rocio 220 - 5th floor, Suite 51,
CEP: 04552-903-SÃO PAULO-SP, Brazil.
P.O. Box 7383 (01064-970).

Tel. (011)821-2333, Fax. (011)829-1849

Canada: PHILIPS SEMICONDUCTORS/COMPONENTS:
Tel. (800) 234-7381, Fax. (708) 296-8556

Chile: Av. Santa Maria 0760, SANTIAGO,
Tel. (02)773 816, Fax. (02)777 6730

Colombia: IPRELENTO LTDA, Carrera 21 No. 56-17,
77621 BOGOTA, Tel. (571)249 7624/(571)217 4609,
Fax. (571)217 4549

Denmark: Prags Boulevard 80, PB 1919, DK-2300 COPENHAGEN S,
Tel. (032)88 2636, Fax. (031)57 1949

Finland: Sinikalliontie 3, FIN-02630 ESPOO,
Tel. (9)0-50261, Fax. (9)0-520971

France: 4 Rue du Port-aux-Vins, BP317,
92156 SURESNES Cedex,
Tel. (01)4099 6161, Fax. (01)4099 6427

Germany: P.O. Box 10 63 23, 20043 HAMBURG,
Tel. (040)3296-0, Fax. (040)3296 213.

Greece: No. 15, 25th March Street, GR 17778 TAVROS,
Tel. (01)4894 339/4894 911, Fax. (01)4814 240

Hong Kong: PHILIPS HONG KONG Ltd., 6/F Philips Ind. Bldg.,
24-28 Kung Yip St., KWAI CHUNG, N.T.,
Tel. (852)424 5121, Fax. (852)428 6729

India: Philips INDIA Ltd, Shivsagar Estate, A Block,
Dr. Annie Besant Rd. Worli, Bombay 400 018
Tel. (022)4938 541, Fax. (022)4938 722

Indonesia: Philips House, Jalan H.R. Rasuna Said Kav. 3-4,
P.O. Box 4252, JAKARTA 12950,
Tel. (021)5201 122, Fax. (021)5205 189

Ireland: Newstead, Clonskeagh, DUBLIN 14,
Tel. (01)640 000, Fax. (01)640 200

Italy: PHILIPS SEMICONDUCTORS S.r.l.,
Piazza IV Novembre 3, 20124 MILANO,
Tel. (0039)2 6752 2531, Fax. (0039)2 6752 2557

Japan: Philips Bldg 13-37, Kohnan2-chome, Minato-ku, TOKYO 108,
Tel. (03)3740 5028, Fax. (03)3740 0580

Korea: (Republic of) Philips House, 260-199 Itaewon-dong,
Yongsan-ku, SEOUL, Tel. (02)794-5011, Fax. (02)798-8022

Malaysia: No. 76 Jalan Universiti, 46200 PETALING JAYA,
SELANGOR, Tel. (03)750 5214, Fax. (03)757 4880

Mexico: 5900 Gateway East, Suite 200, EL PASO, TX 79905,
Tel. 9-5(800)234-7381, Fax. (708)296-8556

Netherlands: Postbus 90050, 5600 PB EINDHOVEN, Bldg. VB
Tel. (040)783749, Fax. (040)788399

New Zealand: 2 Wagener Place, C.P.O. Box 1041, AUCKLAND,
Tel. (09)849-4160, Fax. (09)849-7811

Norway: Box 1, Manglerud 0612, OSLO,
Tel. (022)74 8000, Fax. (022)74 8341

Pakistan: Philips Electrical Industries of Pakistan Ltd.,
Exchange Bldg. ST-2/A, Block 9, KDA Scheme 5, Clifton,
KARACHI 75600, Tel. (021)587 4641-49,
Fax. (021)577035/5874546.

Philippines: PHILIPS SEMICONDUCTORS PHILIPPINES Inc,
196 Valero St. Salcedo Village, P.O. Box 2108 MCC, MAKATI,
Metro MANILA, Tel. (02)810 0161, Fax. (02)817 3474

Portugal: PHILIPS PORTUGUESA, S.A.,
Rua dr. António Loureiro Borges 5, Arquiparque - Miraflores,
Apartado 300, 2795 LINDA-A-VELHA,
Tel. (01)4163160/4163333, Fax. (01)4163174/4163366.

Singapore: Lorong 1, Toa Payoh, SINGAPORE 1231,
Tel. (65)350 2000, Fax. (65)251 6500

South Africa: S.A. PHILIPS Pty Ltd.,
195-215 Main Road Martindale, 2092 JOHANNESBURG,
P.O. Box 7430 Johannesburg 2000,
Tel. (011)470-5911, Fax. (011)470-5494.

Spain: Balmes 22, 08007 BARCELONA,
Tel. (03)301 6312, Fax. (03)301 42 43

Sweden: Kottbygatan 7, Akalla. S-164 85 STOCKHOLM,
Tel. (0)8-632 2000, Fax. (0)8-632 2745

Switzerland: Allmendstrasse 140, CH-8027 ZÜRICH,
Tel. (01)488 2211, Fax. (01)481 77 30

Taiwan: PHILIPS TAIWAN Ltd., 23-30F, 66, Chung Hsiao West
Road, Sec. 1, Taipei, Taiwan ROC, P.O. Box 22978,
TAIPEI 100, Tel. (02)388 7666, Fax. (02)382 4382.

Thailand: PHILIPS ELECTRONICS (THAILAND) Ltd.,
209/2 Sanpavuth-Bangna Road Prakanong,
Bangkok 10260, THAILAND,
Tel. (662)398-0141, Fax. (662)398-3319.

Turkey: Talatpasa Cad. No. 5, 80640 GÜLTEPE/ISTANBUL,
Tel. (0212)279 2770, Fax. (0212)269 3094

United Kingdom: Philips Semiconductors LTD.,
276 Bath road, Hayes, MIDDLESEX UB3 5BX,
Tel. (081)73050000, Fax. (081)7548421

United States: 811 East Arques Avenue, SUNNYVALE,
CA 94088-3409, Tel. (800)234-7381, Fax. (708)296-8556

Uruguay: Coronel Mora 433, MONTEVIDEO,
Tel. (02)70-4044, Fax. (02)92 0601

For all other countries apply to: Philips Semiconductors,
International Marketing and Sales, Building BE-p,
P.O. Box 218, 5600 MD, EINDHOVEN, The Netherlands,
Telex 35000 phtcnl, Fax. +31-40-724825

SCD35

© Philips Electronics N.V. 1994

All rights are reserved. Reproduction in whole or in part is prohibited without the prior written consent of the copyright owner.

The information presented in this document does not form part of any quotation or contract, is believed to be accurate and reliable and may be changed without notice. No liability will be accepted by the publisher for any consequence of its use. Publication thereof does not convey nor imply any license under patent- or other industrial or intellectual property rights.

Printed in The Netherlands

Philips Semiconductors



PHILIPS