

DATA SHEET

TDA1579

TDA1579T

Decoder for traffic warning (VWF)
radio transmissions

Product specification
File under Integrated Circuits, IC01

May 1992

Decoder for traffic warning (VWF) radio transmissions

TDA1579
TDA1579T

GENERAL DESCRIPTION

The TDA1579 decoder is for radio transmissions having 57 kHz amplitude-modulated subcarriers as used in the German 'Verkehrs Warnfunk' (VWF) traffic warning system.

Features

- Selective subcarrier amplifier (57 kHz) with gain control
- Transmitter identification signal (SK) decoder
- Area identification signal (BK) and announcement identification signal (DK) active filtering
- BK and DK decoders (Schmitt trigger with switched hysteresis)
- BK and DK switch-on/switch-off delay circuits
- Driver output for SK indicator (LED)
- SK and BK control outputs.

QUICK REFERENCE DATA

Measured in Fig.1 at $V_{iSK} = 8$ mV; $f = 57$ kHz amplitude modulated with $f_m = 34.95$ Hz and $m = 60\%$ for 'BK-traffic area C' signal; or with $f_m = 125$ Hz and $m = 30\%$ for DK signal.

PARAMETER	CONDITIONS	SYMBOL	MIN.	TYP.	MAX.	UNIT
Supply voltage		V_P	7.5	8.5	12	V
Supply current		I_P	–	6	–	mA
Nominal input voltage	at $f = 57$ kHz	V_{iSK}	–	8	–	mV
Input impedance	at $f \leq 57$ kHz	$ Z_i $	100	–	–	k Ω
Control level	–3 dB	V_{iSK}	–	2.4	–	mV
Input voltage	peak-to-peak value	$V_{i(p-p)}$	2	–	–	V
SK switch-on threshold level		m_{BKon}	–	42	–	%
SK switch hysteresis		Δm_{BK}	–	3.5	–	dB
SK switch-on delay		t_{dSKon}	–	150	–	ms
SK switch-off delay		t_{dSKoff}	–	750	–	ms
DK switch-on threshold level		m_{DKon}	–	13	–	%
DK switch hysteresis		Δm_{DK}	–	3.6	–	dB
DK switch-on delay		t_{dDKon}	–	750	–	ms
DK switch-off delay		t_{dDKoff}	–	750	–	ms
Ambient operating temperature range		T_{amb}	–30	–	+ 80	$^{\circ}\text{C}$

PACKAGE OUTLINES

TDA1579: 18-lead DIL; plastic (SOT102); SOT102-1; 1996 August 12.

TDA1579T: 20-lead mini-pack; plastic (SO20; SOT163A); SOT163-1; 1996 August 12.

Decoder for traffic warning (VWF) radio transmissions

TDA1579 TDA1579T

RATINGS

Limiting values in accordance with the Absolute Maximum System (IEC 134). All pin numbers in this table apply to TDA1579; for TDA1579T refer to Fig.1.

PARAMETER	CONDITIONS	SYMBOL	MIN.	TYP.	MAX.	UNIT
Supply voltage	pin 7	$V_P = V_{7-18}$	–	–	15	V
Switch output voltage	pin 1	V_{1-18}	–	–	23	V
	pins 2 or 3	$V_{2; 3-18}$	–	–	15	V
	pins 1, 2 or 3	$-V_{1; 2; 3-18}$	–	–	0.5	V
Switch output current	pin 1	I_1	–	–	50	mA
	pins 2 or 3	$I_{2; 3}$	–	–	5	mA
	pins 1, 2 or 3	$-I_{1; 2; 3}$	–	–	10	mA
Signal input voltage	pin 13	V_{13-18}	–	–	V_P	
	pin 13	$-V_{13-18}$	–	–	0.5	V
Signal input current	pin 13	$-I_{13}$	–	–	10	mA
Total power dissipation		P_{tot}	–	–	800	mW
Storage temperature range		T_{stg}	–55	–	+150	°C
Operating ambient temperature range		T_{amb}	–30	–	+80	°C

CHARACTERISTICS

$V_P = 8.5$ V; $T_{amb} = 25$ °C; measured at nominal input signal: $V_{iSK} = 8$ mV, $f = 57$ kHz amplitude modulated with $f_m = 34.95$ Hz and $m = 60\%$ for 'BK-traffic area C' signal; or with $f_m = 125$ Hz and $m = 30\%$ for DK signal.

All pin numbers in this table apply to TDA1579, for TDA1579T refer to Fig.1.

PARAMETER	CONDITIONS	SYMBOL	MIN.	TYP.	MAX.	UNIT
Supply voltage	pin 7	V_P	7.5	–	12	V
Supply current	pin 7	I_P	–	6	10	mA
SK amplifier/decoder						
Input impedance	$f \leq 57$ kHz	$ Z_i $	100	–	–	k Ω
Input voltage (peak-to-peak value)		$V_{i(p-p)}$	2	–	–	V
Input voltage at start of gain control	$V_{09BK} = -3$ dB	V_{iSK}	–	2.4*	–	mV
Voltage gain	V_{9BK}/V_{13SK}	G_{v9-13}	–	44*	–	dB
Gain spread		$\pm \Delta G_{v9-13}$	–	–	2	dB
Gain control range		ΔG_v	40	–	–	dB
Controlled output voltage		V_{09BK}	–	440	–	mV
		V_{09DK}	–	220	–	mV

Decoder for traffic warning (VWF) radio transmissions

TDA1579
TDA1579T

PARAMETER	CONDITIONS	SYMBOL	MIN.	TYP.	MAX.	UNIT
BK circuit						
Switch-on threshold level	pin 3 high-Z	V_{o5BKon}	600	670	750	mV
Switch hysteresis		$\frac{V_{o5BKon}}{V_{o5BKoff}}$	3	3.5	4	dB
BK switch threshold level for BK-off (SK-off)	pin 3 conducting	$V_{4-18off}$	0.8	0.88	0.97	V
(typ. value = $0.21V_{8-18}$)						
SK output (pin 3)						
allowable load current		I_3	–	–	1.5	mA
saturation voltage	$I_3 = 1.5 \text{ mA}$	$V_{3-18sat}$	–	–	0.35	V
rejection voltage	$I_3 < 5 \mu\text{A}$	V_{3-18}	18	–	–	V
Indicator driver (pin 1)						
allowable load current		I_1	–	–	40	mA
saturation voltage	$I_1 = 20 \text{ mA}$	$V_{1-18sat}$	–	–	0.8	V
rejection voltage	$I_1 < 10 \mu\text{A}$	V_{1-18}	23	–	–	V
DK circuit						
Switch-on threshold level	pin 2 high-Z	V_{15DKon}	600	670	750	mV
Switch hysteresis		$\frac{V_{15DKon}}{V_{15DKoff}}$	3.1	3.6	4.1	dB
DK switch threshold level for DK-off (Schmitt trigger output)	pin 2 conducting	$V_{16-18off}$	–	0.6	–	V
(typ. value $1 \times V_{BE}$)						
DK output (pin 2)						
allowable load current		I_2	–	–	1.5	mA
saturation voltage	$I_2 = 1.5 \text{ mA}$	$V_{2-18sat}$	–	–	0.35	V
rejection voltage	$I_2 < 5 \mu\text{A}$	V_{2-18}	18	–	–	V
BK and DK filter amplifiers						
Open loop gain	$f = 100 \text{ Hz}$	G_o	84	–	–	dB
Current gain		G_i	120	–	–	dB
Input bias current		$\pm I_i$	–	–	50	nA
Output offset voltage	$R_{5-6} = R_{14-15}$ $= 680 \text{ k}\Omega$	$\pm V_{o5-8}$ $\pm V_{15-8}$	–	–	50	mV
Available output current		$\pm I_o$	1	–	–	mA
Output resistance		R_o	–	2	3.5	k Ω
Allowable load capacitance		C_L	–	–	50	pF

**Decoder for traffic warning (VWF) radio
transmissions**
**TDA1579
TDA1579T**

PARAMETER	CONDITIONS	SYMBOL	MIN.	TYP.	MAX.	UNIT
Internal reference voltage						
Output voltage (typ. value = $0.5 V_P$)		V_{8-18}	4.0	4.25	4.5	V
Internal resistance of voltage source		R_8	–	–	5	Ω
Available output current		$-I_8$	2	–	–	mA
		$+I_8$	0.6	–	–	mA
Output short-circuit current (typ. value = $V_P/1 \text{ k}\Omega$)		$-I_{8sc}$	–	8	–	mA
Reference current source						
Reference voltage (typ. value = $V_{8-18} - V_{BE}$)		V_{17-18}	–	3.6	–	V
Internal biasing resistor		R_{i17}	–	5	–	$\text{k}\Omega$
Allowable range of external reference resistor		R_{17-18}	180	–	270	$\text{k}\Omega$

* Selectable by R_{12-8} or Z_{10-8} .

Decoder for traffic warning (VWF) radio transmissions

TDA1579
TDA1579T

APPLICATION INFORMATION (Fig.1)

PARAMETER	SYMBOL		APPLICATION	UNIT
SK switch-on threshold level at $m_{BK} = 60\%$	V_{iSKon}	typ.	1.8	mV
SK switch-on threshold level at $V_{iSK} = 8$ mV	m_{BKon}	typ. >	32 3.0	% dB
SK switch hysteresis	$\frac{m_{BKon}}{m_{BKoff}}$	typ. <	3.5 4.0	dB dB
SK switch-on delay (note 1)	t_{dSKon}	typ. <	95 130	ms ms
SK switch-off delay (note 2)	t_{dSKoff}	> typ. <	380 500 620	ms ms ms
DK switch-on threshold level at $m_{DK} = 30\%$	V_{iDKon}	typ.	1.5	mV
DK switch-on threshold level at $V_{iDK} = 8$ mV	m_{DKon}	typ. >	13 3.1	% dB
DK switch hysteresis	$\frac{m_{DKon}}{m_{DKoff}}$	typ. <	3.6 4.1	dB dB
DK switch-on delay (note 1)	t_{dDKon}	typ. <	750 1000	ms ms
DK switch-off delay (note 2)	t_{dDKoff}	> typ. <	600 750 1000	ms ms ms

Notes

1. Sequence for measuring switch-on delay times (t_{don})

- Nominal BK or DK input signal at pin 13: $V_{i(p-p)} = 8$ mV; $f = 57$ kHz; modulation-on.
- Pin 4 of the BK detector (pin 16 of the DK detector) is switched to ground to cause a low signal at the SK output at pin 3 (DK output at pin 2).
- t_{don} commences when the ground connection is removed from pin 4 (pin 16) as the positive-going V_{oBK} signal at pin 5 (V_{oDK} signal at pin 15) crosses zero.
 t_{don} ends when the positive-going edge of the SK output arrives at pin 13 (DK at pin 2).

2. Sequence for measuring switch-off delay times (t_{doff})

- Nominal operating conditions as in note 1.
- t_{doff} commences when the input is switched off as the negative-going V_{oBK} signal at pin 5 (V_{oDK} signal at pin 15) crosses zero.
 t_{doff} ends when the negative-going edge of the SK output arrives at pin 3 (DK at pin 2).

Decoder for traffic warning (VWF) radio transmissions

TDA1579
TDA1579T

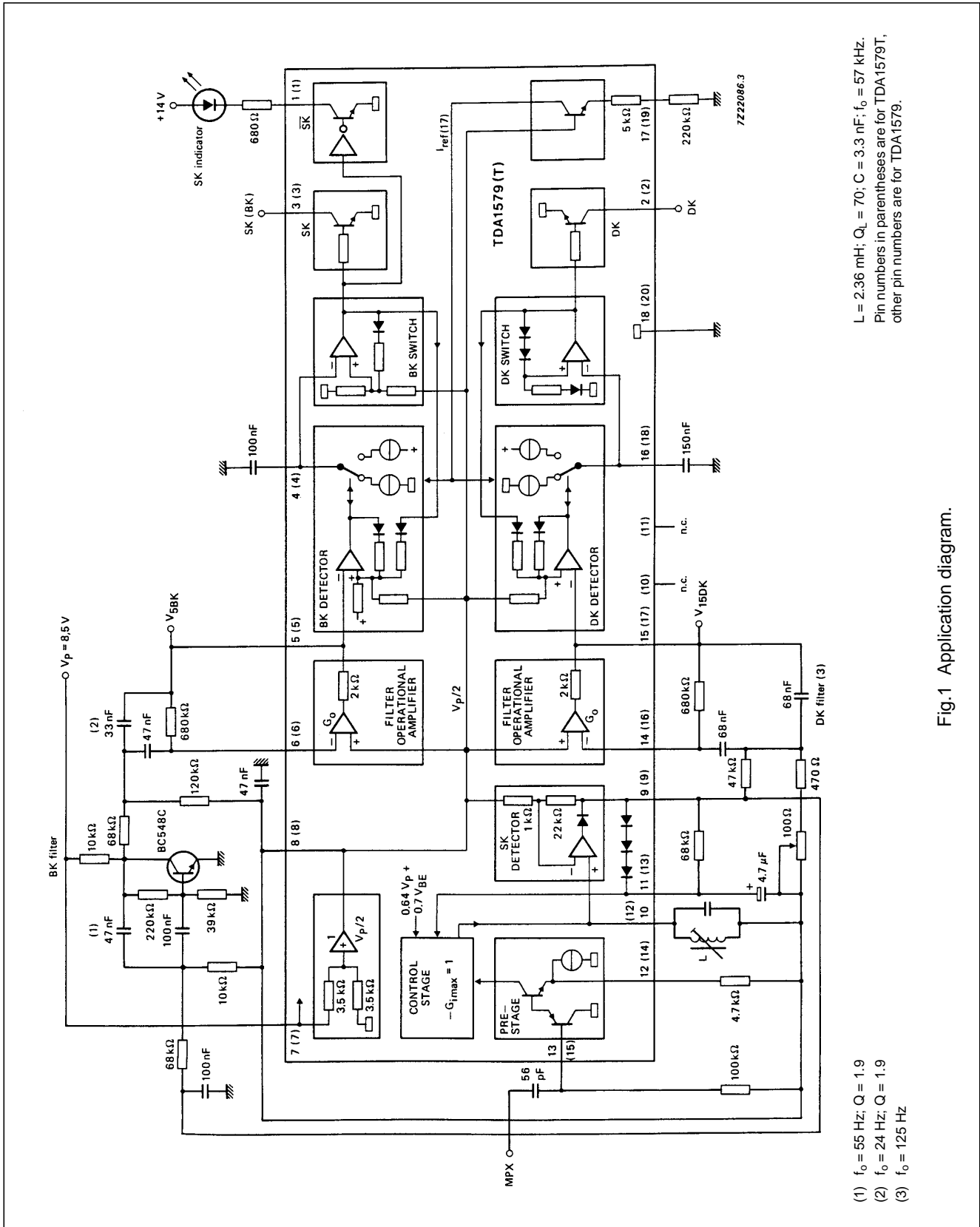

$L = 2.36 \text{ mH}; Q_L = 70; C = 3.3 \text{ nF}; f_0 = 57 \text{ kHz}.$
Pin numbers in parentheses are for TDA1579T,
other pin numbers are for TDA1579.

(1) $f_0 = 55 \text{ Hz}; Q = 1.9$
(2) $f_0 = 24 \text{ Hz}; Q = 1.9$
(3) $f_0 = 125 \text{ Hz}$

Fig.1 Application diagram.

Decoder for traffic warning (VWF) radio transmissions

TDA1579
TDA1579T

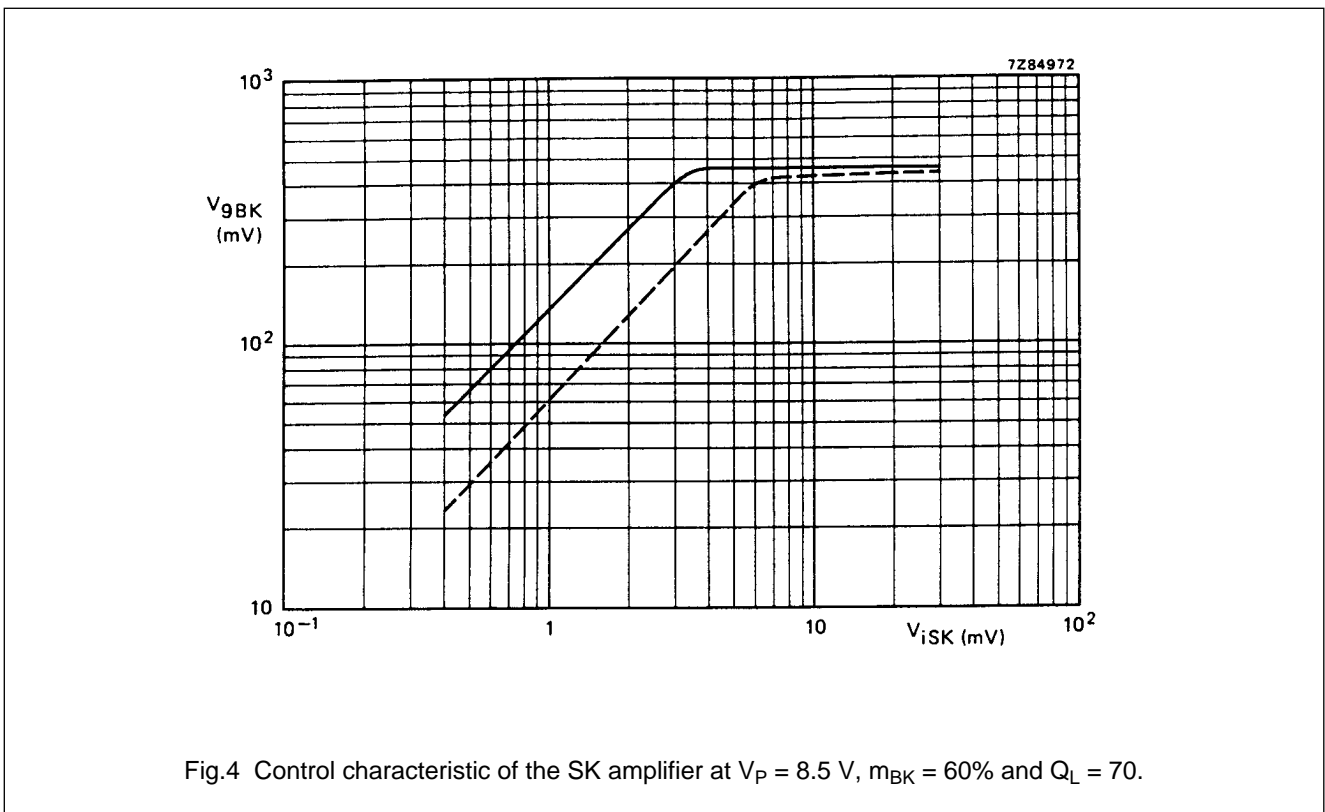
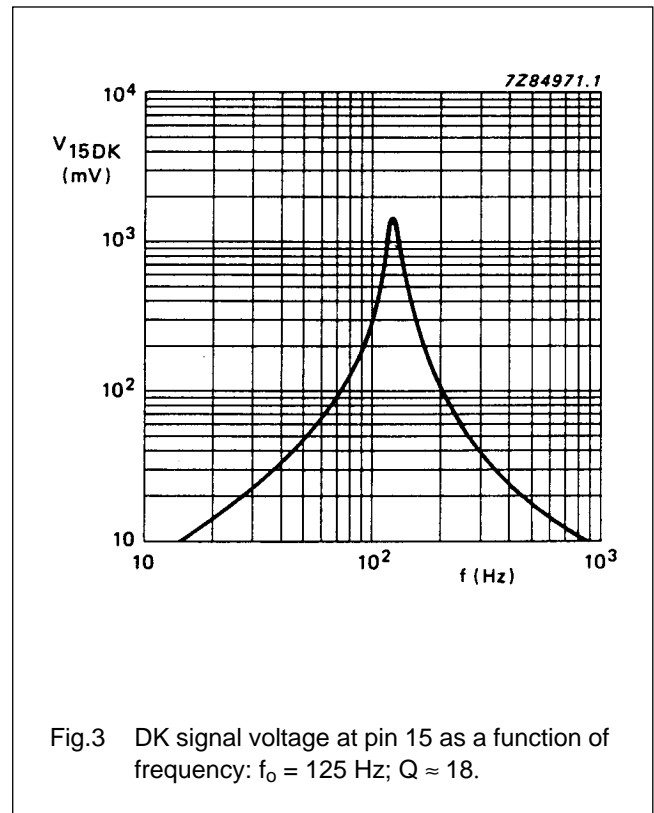
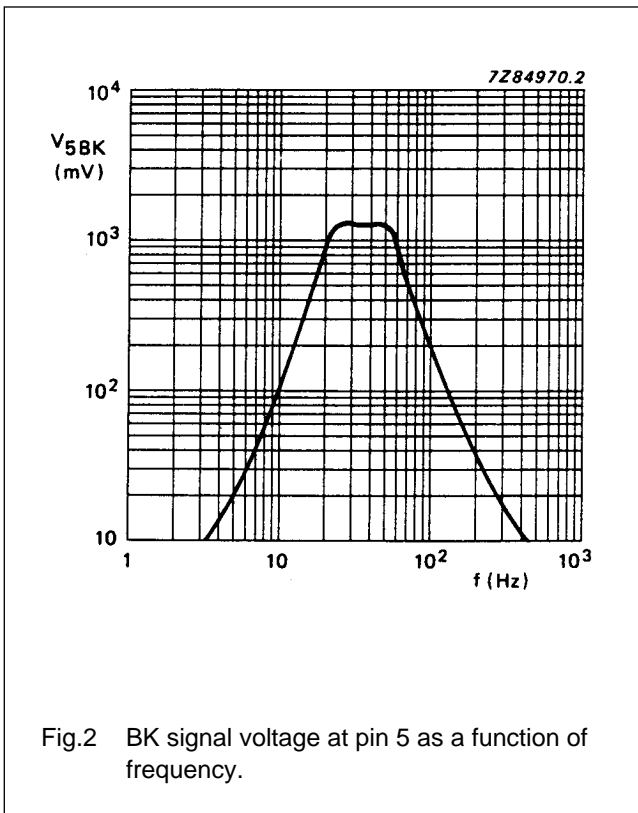

Decoder for traffic warning (VWF) radio transmissions

TDA1579
TDA1579T

FILTER INFORMATION

Gain

Amplifier conditions: $G_o \gg G_v$ and $G_o \gg 2 \cdot Q^2$

$$G_v = \frac{\frac{p}{R1 \cdot C1}}{p^2 + p \frac{C1 + C2}{R3 \cdot C1 \cdot C2} + \frac{R1 + R2}{R1 \cdot R2 \cdot R3 \cdot C1 \cdot C2}}, \text{ in which } p = j\omega \text{ and } G_v = \frac{V_o}{V_i}.$$

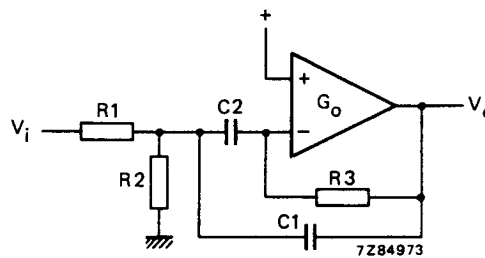

	GENERAL EQUATION	C1 = C2 = C	C1 = C2 = C R2 << R1
Resonance frequency	$\omega_r = \frac{1}{\sqrt{\frac{R1 \cdot R2}{R1 + R2} \cdot R3 \cdot C1 \cdot C2}}$	$\frac{1}{C \sqrt{\frac{R1 \cdot R2}{R1 + R2} \cdot R3}}$	$\frac{1}{C \sqrt{R2 \cdot R3}}$
Gain at $\omega = \omega_r$	$-G_{vr} = \frac{C2}{C1 + C2} \cdot \frac{R3}{R1}$	$\frac{1}{2} \cdot \frac{R3}{R1}$	$\frac{1}{2} \cdot \frac{R3}{R1}$
Quality	$Q = \frac{\sqrt{C1 \cdot C2}}{C1 + C2} \cdot \sqrt{\frac{R3(R1 + R2)}{R1 \cdot R2}}$	$\frac{1}{2} \sqrt{\frac{R3(R1 + R2)}{R1 \cdot R2}}$	$\frac{1}{2} \cdot \frac{R3}{R2}$

Recommended components

- C1, C2 metallized polycarbonate film (MKC) capacitors; ± 5%
- and
- R1, R2, R3 metal film (MR) resistors; ± 2%
- or
- C1, C2 metallized polyester film (MKT) capacitors; ± 5%
- and
- R1, R2, R3 carbon film (CR) resistors; ± 2%

Decoder for traffic warning (VWF) radio transmissions

TDA1579
TDA1579T

PACKAGE OUTLINES

DIP18: plastic dual in-line package; 18 leads (300 mil)

SOT102-1

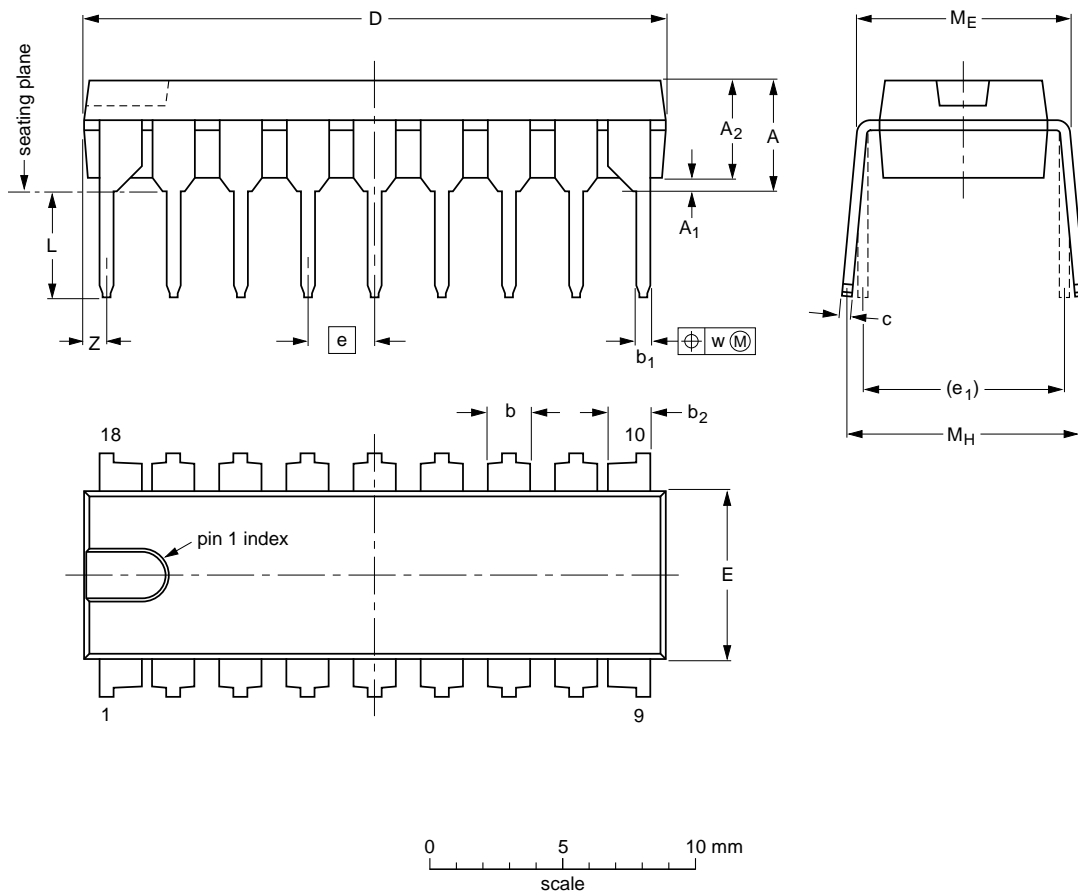

DIMENSIONS (inch dimensions are derived from the original mm dimensions)

UNIT	A max.	A ₁ min.	A ₂ max.	b	b ₁	b ₂	c	D ⁽¹⁾	E ⁽¹⁾	e	e ₁	L	M _E	M _H	w	Z ⁽¹⁾ max.
mm	4.7	0.51	3.7	1.40 1.14	0.53 0.38	1.40 1.14	0.32 0.23	21.8 21.4	6.48 6.20	2.54	7.62	3.9 3.4	8.25 7.80	9.5 8.3	0.254	0.85
inches	0.19	0.020	0.15	0.055 0.044	0.021 0.015	0.055 0.044	0.013 0.009	0.86 0.84	0.26 0.24	0.10	0.30	0.15 0.13	0.32 0.31	0.37 0.33	0.01	0.033

Note

1. Plastic or metal protrusions of 0.25 mm maximum per side are not included.

OUTLINE VERSION	REFERENCES				EUROPEAN PROJECTION	ISSUE DATE
	IEC	JEDEC	EIAJ			
SOT102-1						93-10-14 95-01-23

Decoder for traffic warning (VWF) radio transmissions

TDA1579
TDA1579T

SO20: plastic small outline package; 20 leads; body width 7.5 mm

SOT163-1

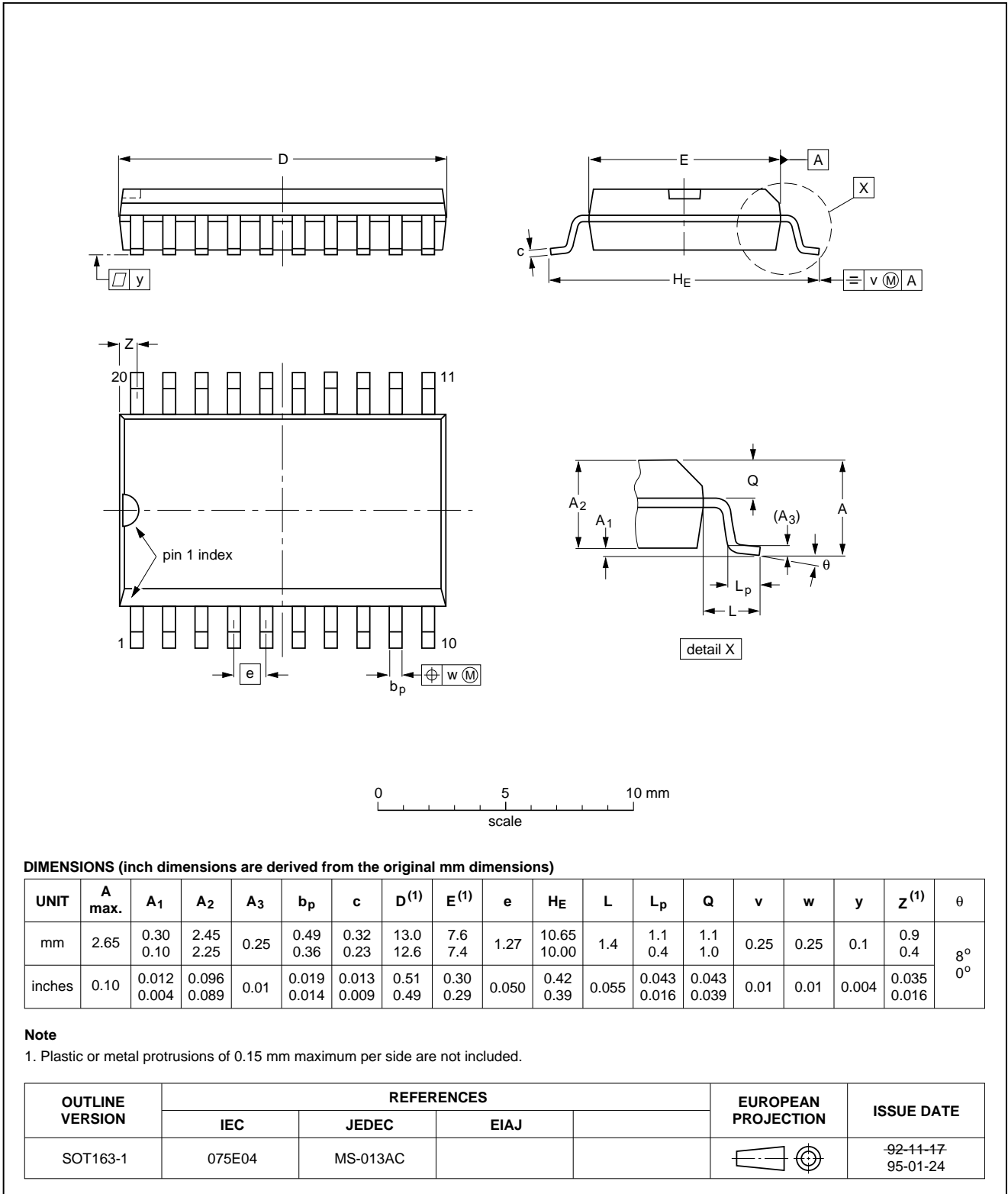

Decoder for traffic warning (VWF) radio transmissions

TDA1579
TDA1579T

SOLDERING

Introduction

There is no soldering method that is ideal for all IC packages. Wave soldering is often preferred when through-hole and surface mounted components are mixed on one printed-circuit board. However, wave soldering is not always suitable for surface mounted ICs, or for printed-circuits with high population densities. In these situations reflow soldering is often used.

This text gives a very brief insight to a complex technology. A more in-depth account of soldering ICs can be found in our "IC Package Databook" (order code 9398 652 90011).

DIP

SOLDERING BY DIPPING OR BY WAVE

The maximum permissible temperature of the solder is 260 °C; solder at this temperature must not be in contact with the joint for more than 5 seconds. The total contact time of successive solder waves must not exceed 5 seconds.

The device may be mounted up to the seating plane, but the temperature of the plastic body must not exceed the specified maximum storage temperature ($T_{stg\ max}$). If the printed-circuit board has been pre-heated, forced cooling may be necessary immediately after soldering to keep the temperature within the permissible limit.

REPAIRING SOLDERED JOINTS

Apply a low voltage soldering iron (less than 24 V) to the lead(s) of the package, below the seating plane or not more than 2 mm above it. If the temperature of the soldering iron bit is less than 300 °C it may remain in contact for up to 10 seconds. If the bit temperature is between 300 and 400 °C, contact may be up to 5 seconds.

SO

REFLOW SOLDERING

Reflow soldering techniques are suitable for all SO packages.

Reflow soldering requires solder paste (a suspension of fine solder particles, flux and binding agent) to be applied to the printed-circuit board by screen printing, stencilling or pressure-syringe dispensing before package placement.

Several techniques exist for reflowing; for example, thermal conduction by heated belt. Dwell times vary between 50 and 300 seconds depending on heating method. Typical reflow temperatures range from 215 to 250 °C.

Preheating is necessary to dry the paste and evaporate the binding agent. Preheating duration: 45 minutes at 45 °C.

WAVE SOLDERING

Wave soldering techniques can be used for all SO packages if the following conditions are observed:

- A double-wave (a turbulent wave with high upward pressure followed by a smooth laminar wave) soldering technique should be used.
- The longitudinal axis of the package footprint must be parallel to the solder flow.
- The package footprint must incorporate solder thieves at the downstream end.

During placement and before soldering, the package must be fixed with a droplet of adhesive. The adhesive can be applied by screen printing, pin transfer or syringe dispensing. The package can be soldered after the adhesive is cured.

Maximum permissible solder temperature is 260 °C, and maximum duration of package immersion in solder is 10 seconds, if cooled to less than 150 °C within 6 seconds. Typical dwell time is 4 seconds at 250 °C.

A mildly-activated flux will eliminate the need for removal of corrosive residues in most applications.

REPAIRING SOLDERED JOINTS

Fix the component by first soldering two diagonally-opposite end leads. Use only a low voltage soldering iron (less than 24 V) applied to the flat part of the lead. Contact time must be limited to 10 seconds at up to 300 °C. When using a dedicated tool, all other leads can be soldered in one operation within 2 to 5 seconds between 270 and 320 °C.

Decoder for traffic warning (VWF) radio transmissions

**TDA1579
TDA1579T**

DEFINITIONS

Data sheet status	
Objective specification	This data sheet contains target or goal specifications for product development.
Preliminary specification	This data sheet contains preliminary data; supplementary data may be published later.
Product specification	This data sheet contains final product specifications.
Limiting values	
Limiting values given are in accordance with the Absolute Maximum Rating System (IEC 134). Stress above one or more of the limiting values may cause permanent damage to the device. These are stress ratings only and operation of the device at these or at any other conditions above those given in the Characteristics sections of the specification is not implied. Exposure to limiting values for extended periods may affect device reliability.	
Application information	
Where application information is given, it is advisory and does not form part of the specification.	

LIFE SUPPORT APPLICATIONS

These products are not designed for use in life support appliances, devices, or systems where malfunction of these products can reasonably be expected to result in personal injury. Philips customers using or selling these products for use in such applications do so at their own risk and agree to fully indemnify Philips for any damages resulting from such improper use or sale.