

DATA SHEET

For a complete data sheet, please also download:

- The IC06 74HC/HCT/HCU/HCMOS Logic Family Specifications
- The IC06 74HC/HCT/HCU/HCMOS Logic Package Information
- The IC06 74HC/HCT/HCU/HCMOS Logic Package Outlines

74HC/HCT4020 14-stage binary ripple counter

Product specification
File under Integrated Circuits, IC06

September 1993

14-stage binary ripple counter

74HC/HCT4020

FEATURES

- Output capability: standard
- I_{CC} category: MSI

GENERAL DESCRIPTION

The 74HC/HCT4020 are high-speed Si-gate CMOS devices and are pin compatible with the "4020" of the "4000B" series. They are specified in compliance with JEDEC standard no. 7A.

The 74HC/HCT4020 are 14-stage binary ripple counters with a clock input (\overline{CP}), an overriding asynchronous master reset input (MR) and twelve fully buffered parallel outputs (Q₀, Q₃ to Q₁₃).

The counter is advanced on the HIGH-to-LOW transition of \overline{CP} .

A HIGH on MR clears all counter stages and forces all outputs LOW, independent of the state of \overline{CP} .

Each counter stage is a static toggle flip-flop.

QUICK REFERENCE DATA

GND = 0 V; T_{amb} = 25 °C; t_r = t_f = 6 ns

SYMBOL	PARAMETER	CONDITIONS	TYPICAL		UNIT
			HC	HCT	
t _{PHL} / t _{PLH}	propagation delay \overline{CP} to Q ₀ Q _n to Q _{n+1} MR to Q _n	C _L = 15 pF; V _{CC} = 5 V	11	15	ns
			6	6	ns
			17	19	ns
f _{max}	maximum clock frequency		101	52	MHz
C _I	input capacitance		3.5	3.5	pF
C _{PD}	power dissipation capacitance per package	notes 1 and 2	19	20	pF

Notes

1. C_{PD} is used to determine the dynamic power dissipation (P_D in μW):

$$P_D = C_{PD} \times V_{CC}^2 \times f_i + \sum (C_L \times V_{CC}^2 \times f_o) \text{ where:}$$

f_i = input frequency in MHz

f_o = output frequency in MHz

$\sum (C_L \times V_{CC}^2 \times f_o)$ = sum of outputs

C_L = output load capacitance in pF

V_{CC} = supply voltage in V

2. For HC the condition is V_I = GND to V_{CC}
For HCT the condition is V_I = GND to V_{CC} - 1.5 V

ORDERING INFORMATION

See "74HC/HCT/HCU/HCMOS Logic Package Information".

14-stage binary ripple counter

74HC/HCT4020

PIN DESCRIPTION

PIN NO.	SYMBOL	NAME AND FUNCTION
9, 7, 5, 4, 6, 13, 12, 14, 15, 1, 2, 3	Q ₀ , Q ₃ to Q ₁₃	parallel outputs
8	GND	ground (0 V)
10	\overline{CP}	clock input (HIGH-to-LOW, edge-triggered)
11	MR	master reset input (active HIGH)
16	V _{CC}	positive supply voltage

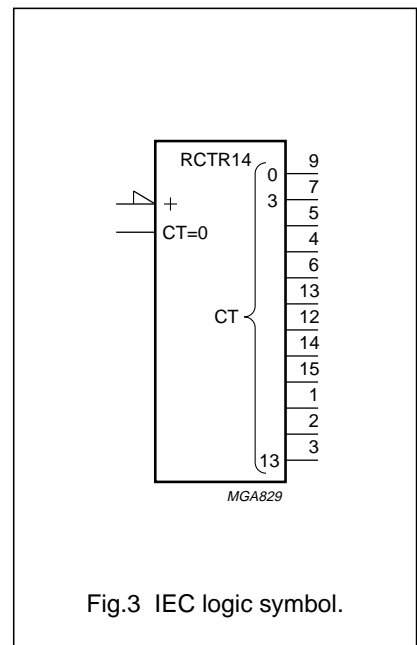
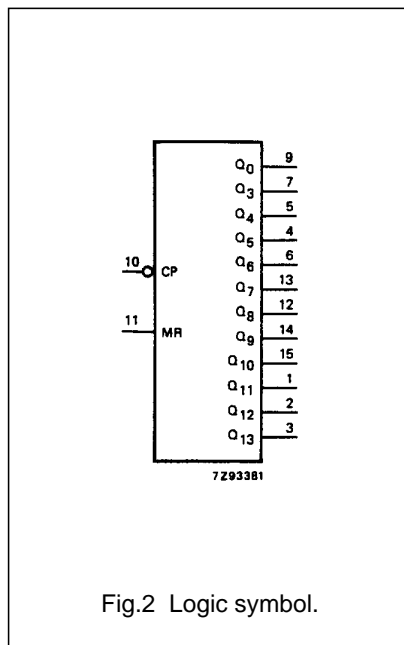
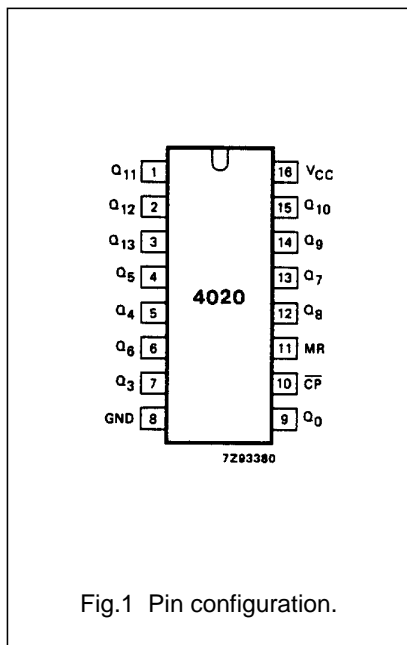

14-stage binary ripple counter

74HC/HCT4020

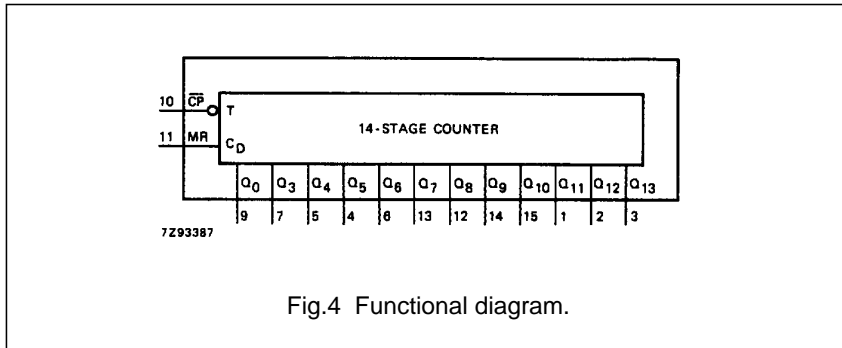

Fig.4 Functional diagram.

FUNCTION TABLE

INPUTS		OUTPUTS
\overline{CP}	MR	Q_0, Q_3 to Q_{13}
↑	L	no change
↓	L	count
X	H	L

Notes

- H = HIGH voltage level
L = LOW voltage level
X = don't care
↑ = LOW-to-HIGH clock transition
↓ = HIGH-to-LOW clock transition

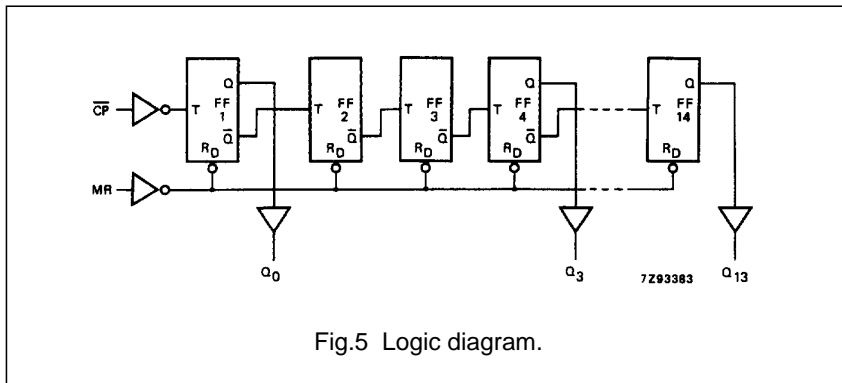

Fig.5 Logic diagram.

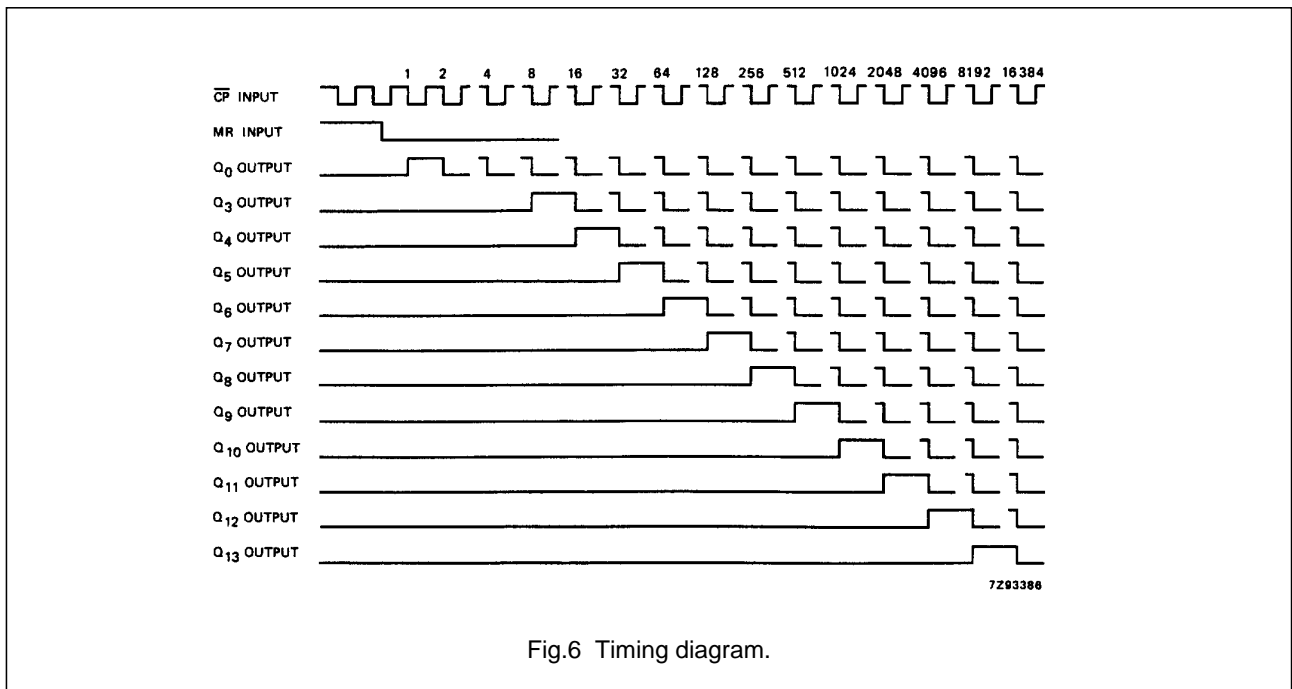

Fig.6 Timing diagram.

14-stage binary ripple counter

74HC/HCT4020

DC CHARACTERISTICS FOR 74HC

For the DC characteristics see *"74HC/HCT/HCU/HCMOS Logic Family Specifications"*.

Output capability: standard

I_{CC} category: MSI

AC CHARACTERISTICS FOR 74HC

GND = 0 V; t_r = t_f = 6 ns; C_L = 50 pF

SYMBOL	PARAMETER	T _{amb} (°C)							UNIT	TEST CONDITIONS	
		74HC								V _{CC} (V)	WAVEFORMS
		+25			-40 to +85		-40 to +125				
		min.	typ.	max.	min.	max.	min.	max.			
t _{PHL} / t _{PLH}	propagation delay CP to Q ₀		39 14 11	140 28 24		175 35 30		210 42 36	ns	2.0 4.5 6.0	Fig.7
t _{PHL} / t _{PLH}	propagation delay Q _n to Q _{n+1}		22 8 6	75 15 13		95 19 16		110 22 19	ns	2.0 4.5 6.0	Fig.7
t _{PHL}	propagation delay MR to Q _n		55 20 16	170 34 29		215 43 37		225 51 43	ns	2.0 4.5 6.0	Fig.8
t _{THL} / t _{TLH}	output transition time		19 7 6	75 15 13		95 19 16		110 22 19	ns	2.0 4.5 6.0	Fig.7
t _w	clock pulse width HIGH or LOW	80 16 14	11 4 3		100 20 17		120 24 20		ns	2.0 4.5 6.0	Fig.7
t _w	master reset pulse width HIGH	80 16 14	17 6 5		100 20 17		120 24 20		ns	2.0 4.5 6.0	Fig.8
t _{rem}	removal time MR to \overline{CP}	50 10 9	6 2 2		65 13 11		75 15 13		ns	2.0 4.5 6.0	Fig.8
f _{max}	maximum clock pulse frequency	6.0 30 35	30 92 109		4.8 24 28		4.0 20 24		MHz	2.0 4.5 6.0	Fig.7

14-stage binary ripple counter

74HC/HCT4020

DC CHARACTERISTICS FOR 74HCT

For the DC characteristics see "*74HC/HCT/HCU/HCMOS Logic Family Specifications*".

Output capability: standard

I_{CC} category: MSI

Note to HCT types

The value of additional quiescent supply current (ΔI_{CC}) for a unit load of 1 is given in the family specifications. To determine ΔI_{CC} per input, multiply this value by the unit load coefficient shown in the table below.

INPUT	UNIT LOAD COEFFICIENT
\overline{CP}	0.85
MR	1.10

AC CHARACTERISTICS FOR 74HCT

GND = 0 V; $t_r = t_f = 6$ ns; $C_L = 50$ pF

SYMBOL	PARAMETER	T _{amb} (°C)							UNIT	TEST CONDITIONS	
		74HCT								V _{CC} (V)	WAVEFORMS
		+25			-40 to +85		-40 to +125				
		min.	typ.	max.	min.	max.	min.	max.			
t _{PHL} / t _{PLH}	propagation delay \overline{CP} to Q ₀		18	36		45		54	ns	4.5	Fig.7
t _{PHL} / t _{PLH}	propagation delay Q _n to Q _{n+1}		8	15		19		22	ns	4.5	Fig.7
t _{PHL}	propagation delay MR to Q _n		22	45		56		68	ns	4.5	Fig.8
t _{THL} / t _{TLH}	output transition time		7	15		19		22	ns	4.5	Fig.7
t _w	clock pulse width HIGH or LOW	20	7		25		30		ns	4.5	Fig.7
t _w	master reset pulse width HIGH	20	8		25		30		ns	4.5	Fig.8
t _{rem}	removal time MR to \overline{CP}	10	2		13		15		ns	4.5	Fig.8
f _{max}	maximum clock pulse frequency	25	47		20		17		MHz	4.5	Fig.7

14-stage binary ripple counter

74HC/HCT4020

AC WAVEFORMS

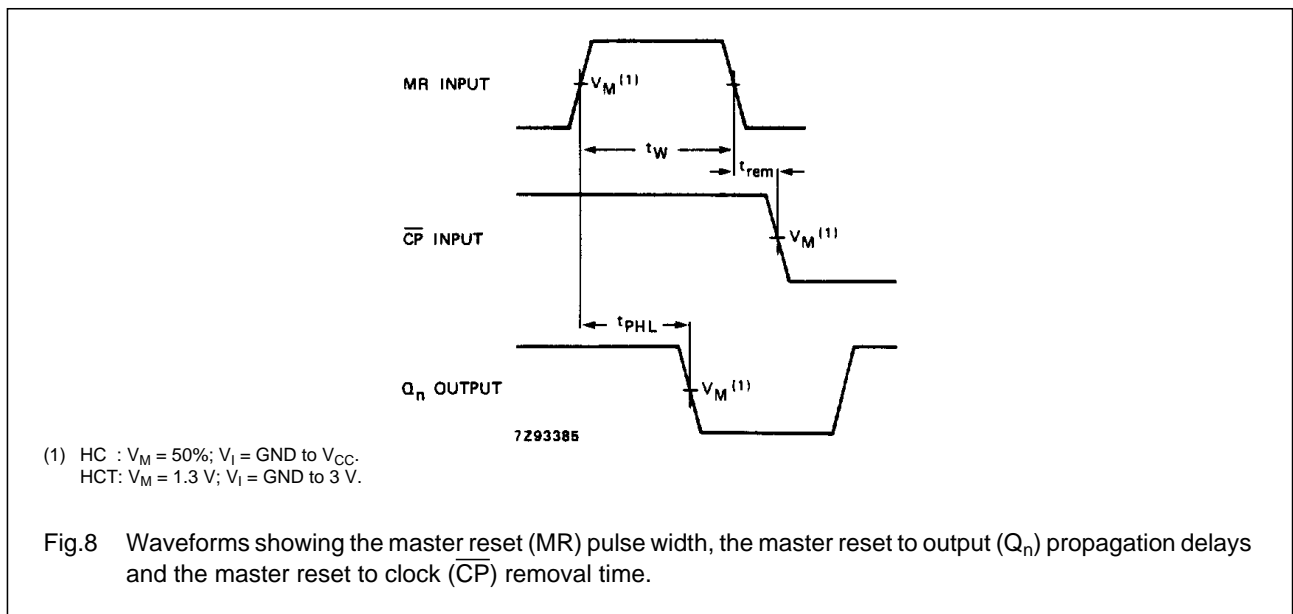
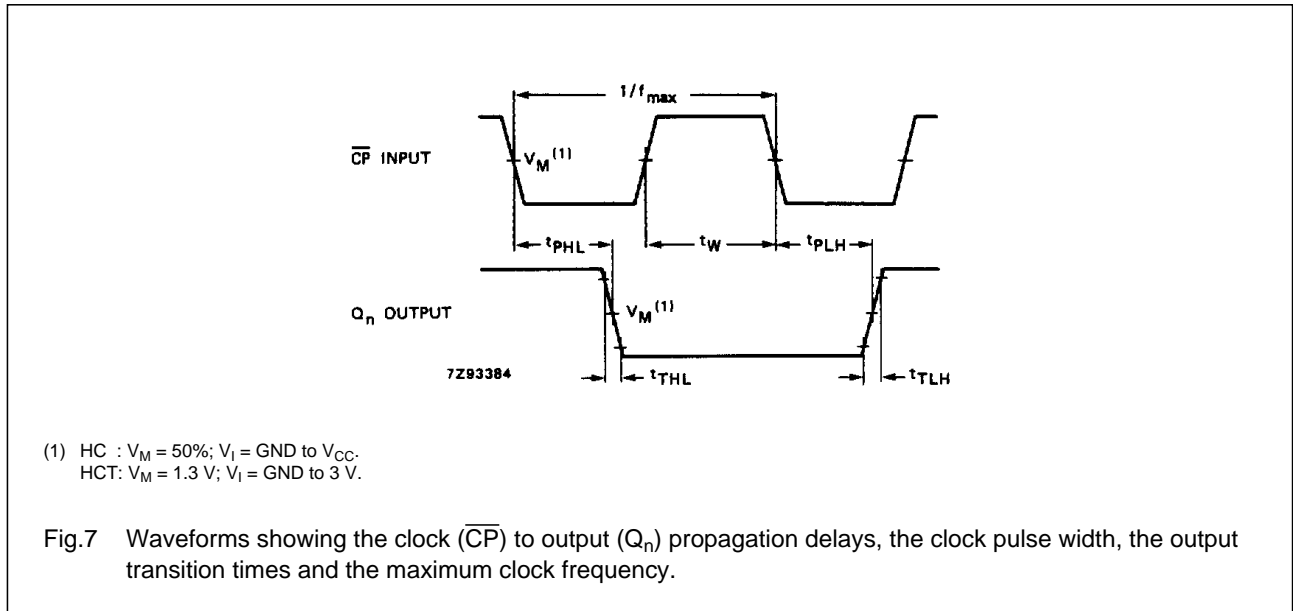

PACKAGE OUTLINES

See "74HC/HCT/HCU/HCMOS Logic Package Outlines".