

DATA SHEET

For a complete data sheet, please also download:

- The IC06 74HC/HCT/HCU/HCMOS Logic Family Specifications
- The IC06 74HC/HCT/HCU/HCMOS Logic Package Information
- The IC06 74HC/HCT/HCU/HCMOS Logic Package Outlines

74HC/HCT4094 8-stage shift-and-store bus register

Product specification
File under Integrated Circuits, IC06

December 1990

8-stage shift-and-store bus register

74HC/HCT4094

FEATURES

- Output capability: standard
- I_{CC} category: MSI

GENERAL DESCRIPTION

The 74HC/HCT4094 are high-speed Si-gate CMOS devices and are pin compatible with the "4094" of the "4000B" series. They are specified in compliance with JEDEC standard no. 7A.

The 74HC/HCT4094 are 8-stage serial shift registers having a storage latch associated with each stage for strobing data from the serial input (D) to the parallel buffered 3-state outputs (QP₀ to QP₇). The parallel outputs may be connected directly to common bus lines. Data is shifted on the positive-going clock (CP) transitions.

The data in each shift register stage is transferred to the storage register when the strobe input (STR) is HIGH. Data in the storage register appears at the outputs whenever the output enable input (OE) signal is HIGH.

Two serial outputs (QS₁ and QS₂) are available for cascading a number of "4094" devices. Data is available at QS₁ on the positive-going clock edges to allow high-speed operation in cascaded systems in which the clock rise time is fast. The same serial information is available at QS₂ on the next negative-going clock edge and is for cascading "4094" devices when the clock rise time is slow.

APPLICATIONS

- Serial-to-parallel data conversion
- Remote control holding register

QUICK REFERENCE DATA

GND = 0 V; T_{amb} = 25 °C; t_r = t_f = 6 ns

SYMBOL	PARAMETER	CONDITIONS	TYPICAL		UNIT
			HC	HCT	
t _{PHL} / t _{PLH}	propagation delay	C _L = 15 pF; V _{CC} = 5 V			
	CP to QS ₁		15	19	ns
	CP to QS ₂		13	18	ns
	CP to QP _n		20	21	ns
	STR to QP _n		18	19	ns
f _{max}	maximum clock frequency		95	86	MHz
C _I	input capacitance		3.5	3.5	pF
C _{PD}	power dissipation capacitance per package	notes 1 and 2	83	92	pF

Notes

1. C_{PD} is used to determine the dynamic power dissipation (P_D in μW):

$$P_D = C_{PD} \times V_{CC}^2 \times f_i + \sum (C_L \times V_{CC}^2 \times f_o) \text{ where:}$$

f_i = input frequency in MHz

f_o = output frequency in MHz

∑ (C_L × V_{CC}² × f_o) = sum of outputs

C_L = output load capacitance in pF

V_{CC} = supply voltage in V

2. For HC the condition is V_I = GND to V_{CC}
For HCT the condition is V_I = GND to V_{CC} – 1.5 V

ORDERING INFORMATION

See "74HC/HCT/HCU/HCMOS Logic Package Information".

8-stage shift-and-store bus register

74HC/HCT4094

PIN DESCRIPTION

PIN NO.	SYMBOL	NAME AND FUNCTION
1	STR	strobe input
2	D	serial input
3	CP	clock input
4, 5, 6, 7, 14, 13, 12, 11	QP ₀ to QP ₇	parallel outputs
8	GND	ground (0 V)
9, 10	QS ₁ , QS ₂	serial outputs
15	OE	output enable input
16	V _{CC}	positive supply voltage

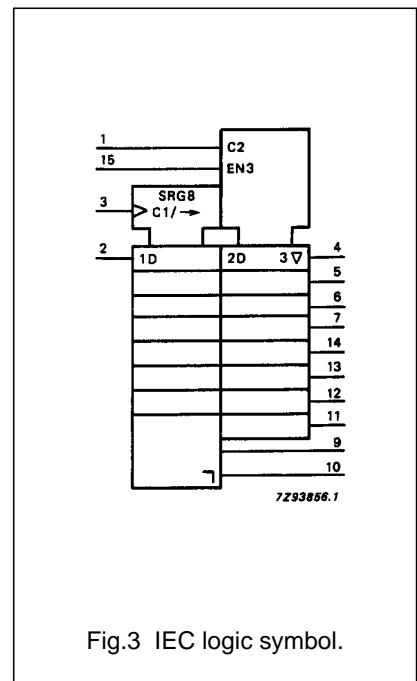
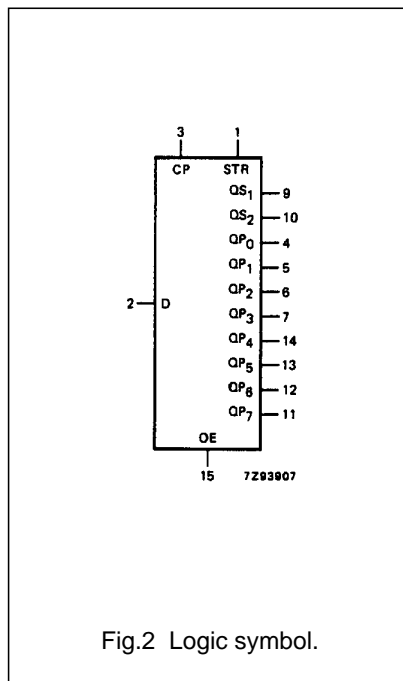
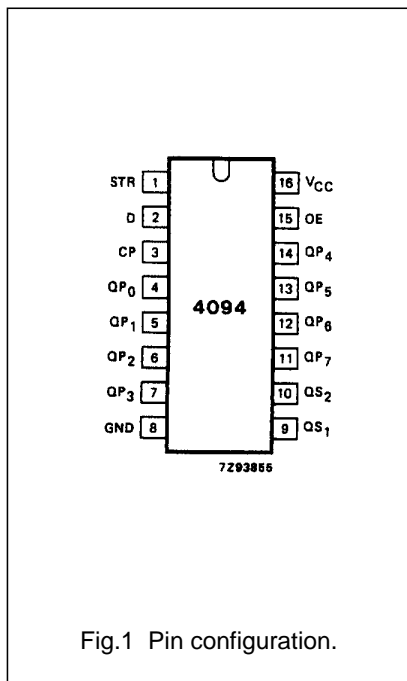

8-stage shift-and-store bus register

74HC/HCT4094

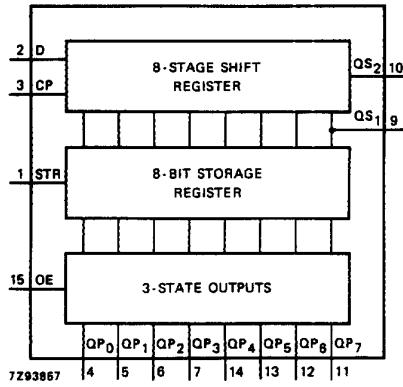

Fig.4 Functional diagram.

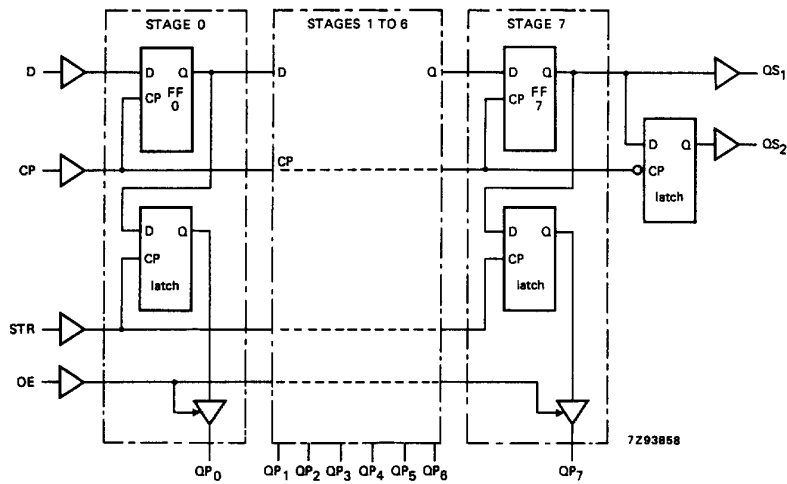

Fig.5 Logic diagram.

8-stage shift-and-store bus register

74HC/HCT4094

FUNCTION TABLE

INPUTS				PARALLEL OUTPUTS		SERIAL OUTPUTS	
CP	OE	STR	D	QP ₀	QP _n	QS ₁	QS ₂
↑	L	X	X	Z	Z	Q' ₆	NC
↓	L	X	X	Z	Z	NC	QP ₇
↑	H	L	X	NC	NC	Q' ₆	NC
↑	H	H	L	L	QP _{n-1}	Q' ₆	NC
↑	H	H	H	H	QP _{n-1}	Q' ₆	NC
↓	H	H	H	NC	NC	NC	QP ₇

Notes

- H = HIGH voltage level
 L = LOW voltage level
 X = don't care
 Z = high impedance OFF-state
 NC= no change
 ↑ = LOW-to-HIGH CP transition
 ↓ = HIGH-to-LOW CP transition
 Q'₆ = the information in the seventh register stage is transferred to the 8th register stage and QS_n output at the positive clock edge

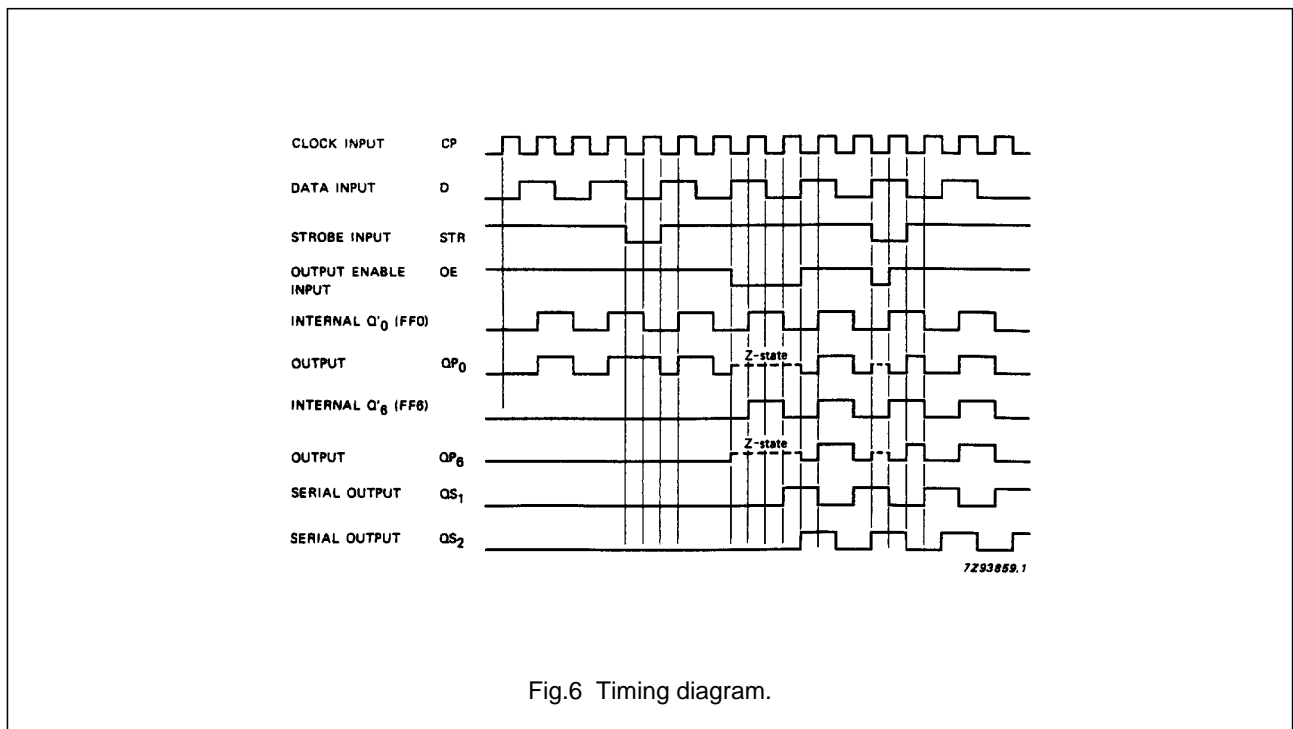

Fig.6 Timing diagram.

8-stage shift-and-store bus register

74HC/HCT4094

DC CHARACTERISTICS FOR 74HC

For the DC characteristics see *"74HC/HCT/HCU/HCMOS Logic Family Specifications"*.

Output capability: standard

I_{CC} category: MSI

AC CHARACTERISTICS FOR 74HC

GND = 0 V; t_r = t_f = 6 ns; C_L = 50 pF

SYMBOL	PARAMETER	T _{amb} (°C)						UNIT	TEST CONDITIONS		
		74HC							V _{CC} (V)	WAVEFORMS	
		+25			-40 to +85		-40 to +125				
		min.	typ.	max.	min.	max.	min.				max.
t _{PHL} / t _{PLH}	propagation delay CP to QS ₁		50 18 14	150 30 26		190 38 33		225 45 38	ns	2.0 4.5 6.0	Fig.7
t _{PHL} / t _{PLH}	propagation delay CP to QS ₂		44 16 13	135 27 23		170 34 29		205 41 35	ns	2.0 4.5 6.0	Fig.7
t _{PHL} / t _{PLH}	propagation delay CP to QP _n		63 23 18	195 39 33		245 49 42		295 59 50	ns	2.0 4.5 6.0	Fig.7
t _{PHL} / t _{PLH}	propagation delay STR to QP _n		58 21 17	180 36 31		225 45 38		270 54 46	ns	2.0 4.5 6.0	Fig.8
t _{PZH} / t _{PZL}	3-state output enable time OE to QP _n		55 20 16	175 35 30		220 44 37		265 53 45	ns	2.0 4.5 6.0	Fig.9
t _{PHZ} / t _{PLZ}	3-state output disable time OE to QP _n		41 15 12	125 25 21		155 31 26		190 38 32	ns	2.0 4.5 6.0	Fig.9
t _{THL} / t _{TLH}	output transition time		19 7 6	75 15 13		95 19 16		110 22 19	ns	2.0 4.5	Fig.7
t _w	clock pulse width HIGH or LOW	80 16 14	14 5 4		100 20 17		120 24 20		ns	2.0 4.5 6.0	Fig.7
t _w	strobe pulse width HIGH	80 16 14	14 5 4		100 20 17		120 24 20		ns	2.0 4.5 6.0	Fig.8
t _{su}	set-up time D to CP	50 10 9	14 5 4		65 13 11		75 15 13		ns	2.0 4.5 6.0	Fig.10
t _{su}	set-up time CP to STR	100 20 17	28 10 8		125 25 21		150 30 26		ns	2.0 4.5 6.0	Fig.8

8-stage shift-and-store bus register

74HC/HCT4094

SYMBOL	PARAMETER	T _{amb} (°C)							UNIT	TEST CONDITIONS	
		74HC								V _{CC} (V)	WAVEFORMS
		+25			-40 to +85		-40 to +125				
		min.	typ.	max.	min.	max.	min.	max.			
t _h	hold time D to CP	3	-6		3		3		ns	2.0 4.5 6.0	Fig.10
t _h	hold time CP to STR	0	-14		0		0		ns	2.0 4.5 6.0	Fig.8
f _{max}	maximum clock pulse frequency	6.0	28		4.8		4.0		MHz	2.0 4.5 6.0	Fig.7

8-stage shift-and-store bus register**74HC/HCT4094**

DC CHARACTERISTICS FOR 74HCT

For the DC characteristics see *"74HC/HCT/HCU/HCMOS Logic Family Specifications"*.

Output capability: standard

I_{CC} category: MSI

Note to HCT types

The value of additional quiescent supply current (ΔI_{CC}) for a unit load of 1 is given in the family specifications. To determine ΔI_{CC} per input, multiply this value by the unit load coefficient shown in the table below.

INPUT	UNIT LOAD COEFFICIENT
OE, CP	1.50
D	0.40
STR	1.00

8-stage shift-and-store bus register

74HC/HCT4094

AC CHARACTERISTICS FOR 74HCT

GND = 0 V; $t_r = t_f = 6$ ns; $C_L = 50$ pF

SYMBOL	PARAMETER	T_{amb} (°C)						UNIT	TEST CONDITIONS		
		74HCT							V_{CC} (V)	WAVEFORMS	
		+25			-40 to +85		-40 to +125				
		min.	typ.	max.	min.	max.	min.				max.
t_{PHL}/t_{PLH}	propagation delay CP to QS_1		23	39		49		59	ns	4.5	Fig.7
t_{PHL}/t_{PLH}	propagation delay CP to QS_2		21	36		45		54	ns	4.5	Fig.7
t_{PHL}/t_{PLH}	propagation delay CP to QP_n		25	43		54		65	ns	4.5	Fig.7
t_{PHL}/t_{PLH}	propagation delay STR to QP_n		22	39		49		59	ns	4.5	Fig.8
t_{PZH}/t_{PZL}	3-state output enable time OE to QP_n		20	35		44		53	ns	4.5	Fig.9
t_{PHZ}/t_{PLZ}	3-state output disable time OE to QP_n		21	35		44		53	ns	4.5	Fig.9
t_{THL}/t_{TLH}	output transition time		7	15		19		22	ns	4.5	Fig.7
t_W	clock pulse width HIGH or LOW	16	7		20		24		ns	4.5	Fig.7
t_W	strobe pulse width HIGH	16	5		20		24		ns	4.5	Fig.8
t_{su}	set-up time D to CP	10	4		13		15		ns	4.5	Fig.10
t_{su}	set-up time CP to STR	20	9		25		30		ns	4.5	Fig.8
t_h	hold time D to CP	4	0		4		4		ns	4.5	Fig.10
t_h	hold time CP to STR	0	-4		0		0		ns	4.5	Fig.8
f_{max}	maximum clock pulse frequency	30	80		24		20		MHz	4.5	Fig.7

8-stage shift-and-store bus register

74HC/HCT4094

AC WAVEFORMS

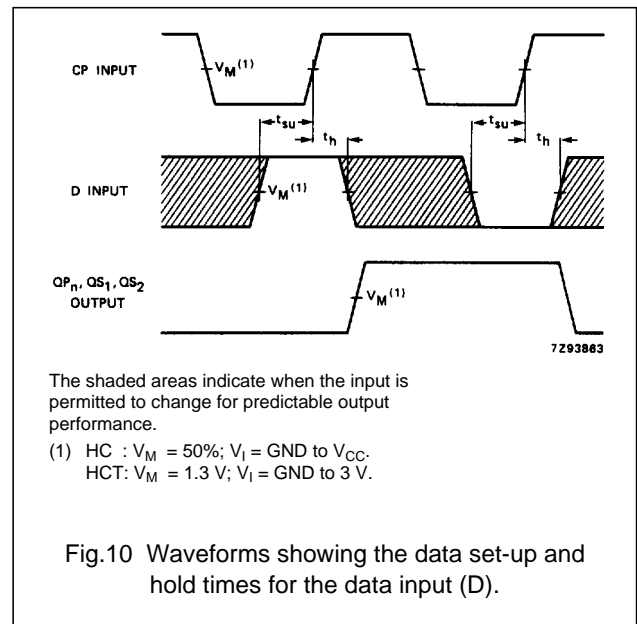
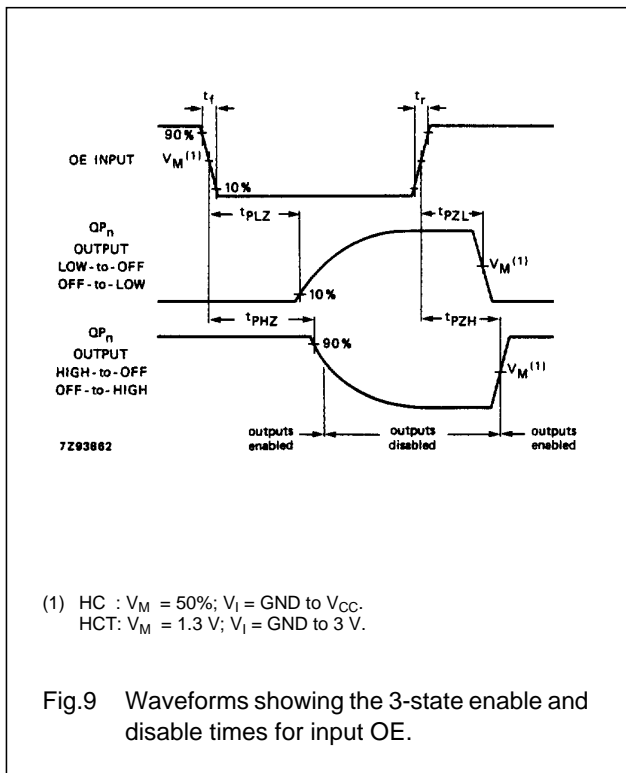
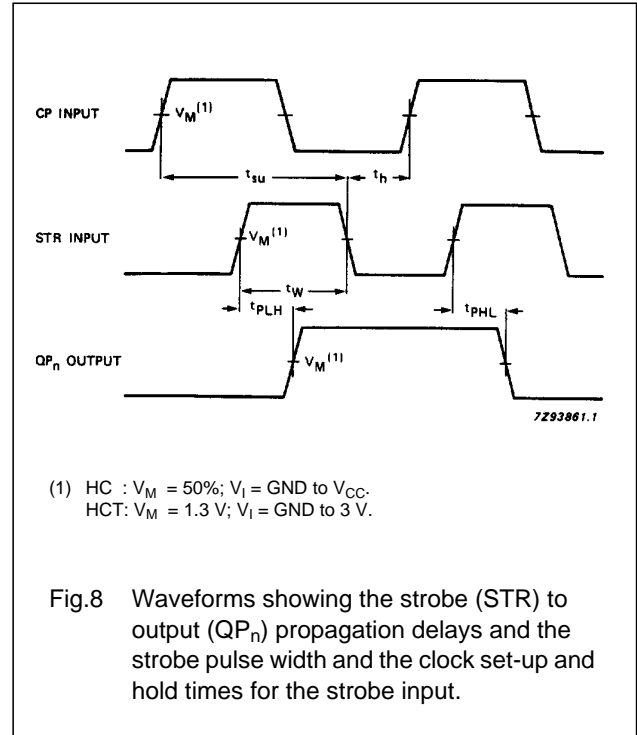
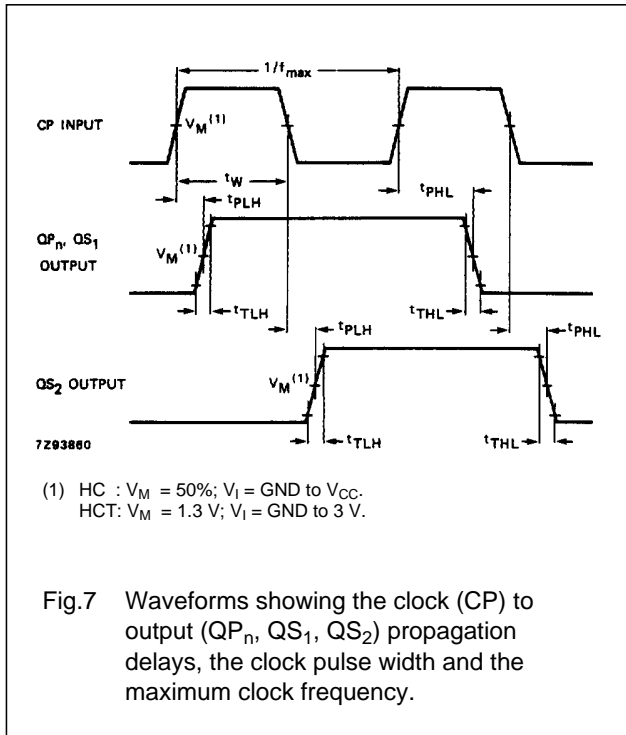

PACKAGE OUTLINES

See "74HC/HCT/HCU/HCMOS Logic Package Outlines".