

DATA SHEET

74HCT9046A

PLL with bandgap controlled VCO

Product specification
Supersedes data of March 1994
File under Integrated Circuits, IC06

1999 Jan 11

PLL with bandgap controlled VCO

74HCT9046A

FEATURES

- Low power consumption
- Centre frequency up to 17 MHz (typ.) at $V_{CC} = 5.5\text{ V}$
- Choice of two phase comparators⁽¹⁾:
 - EXCLUSIVE-OR (PC1)
 - Edge-triggered JK flip-flop (PC2)
- No dead zone of PC2
- Charge pump output on PC2, whose current is set by an external resistor R_b
- Centre frequency tolerance $\pm 10\%$
- Excellent voltage-controlled-oscillator (VCO) linearity
- Low frequency drift with supply voltage and temperature variations
- On chip bandgap reference
- Glitch free operation of VCO, even at very low frequencies
- Inhibit control for ON/OFF keying and for low standby power consumption
- Operation power supply voltage range 4.5 to 5.5 V
- Zero voltage offset due to op-amp buffering
- Output capability: standard
- I_{CC} category: MSI.

APPLICATIONS

- FM modulation and demodulation where a small centre frequency tolerance is essential
- Frequency synthesis and multiplication where a low jitter is required (e.g. Video picture-in-picture)
- Frequency discrimination

(1) R_b connected between pin 15 and ground: PC2 mode, with PCP_{OUT} at pin 2.
Pin 15 left open or connected to V_{CC} : PC1 mode with $PC1_{OUT}$ at pin 2.

- Tone decoding
- Data synchronization and conditioning
- Voltage-to-frequency conversion
- Motor-speed control.

GENERAL DESCRIPTION

The 74HCT9046A is a high-speed Si-gate CMOS device. It is specified in compliance with "JEDEC standard no. 7A".

QUICK REFERENCE DATA

$GND = 0\text{ V}$; $T_{amb} = 25\text{ }^\circ\text{C}$; $t_r = t_f \leq 6\text{ ns}$.

SYMBOL	PARAMETER	CONDITIONS	TYP.	UNIT
f_c	VCO centre frequency	$C_1 = 40\text{ pF}$; $R_1 = 3\text{ k}\Omega$; $V_{CC} = 5\text{ V}$	16	MHz
C_1	input capacitance		3.5	pF
C_{PD}	power dissipation capacitance per package	notes 1 and 2	20	pF

Notes

1. C_{PD} is used to determine the dynamic power dissipation (P_D in μW)
 - a) $P_D = C_{PD} \times V_{CC}^2 \times f_i + \Sigma(C_L \times V_{CC}^2 \times f_o)$ where:
 - b) f_i = input frequency in MHz; C_L = output load capacity in pF;
 f_o = output frequency in MHz; V_{CC} = supply voltage in V;
 $\Sigma(C_L \times V_{CC}^2 \times f_o)$ = sum of the outputs.
2. Applies to the phase comparator section only (inhibit = HIGH). For power dissipation of the VCO and demodulator sections see Figs 26 to 28.

ORDERING INFORMATION

EXTENDED TYPE NUMBER	PACKAGE			
	PINS	PIN POSITION	MATERIAL	CODE
74HCT9046AN	16	DIL16	plastic	SOT38Z
74HCT9046AD	16	SO16	plastic	SOT109A

PLL with bandgap controlled VCO

74HCT9046A

PINNING

SYMBOL	PIN	DESCRIPTION
GND	1	ground (0 V) (phase comparators)
PC1 _{OUT} / PCP _{OUT}	2	phase comparator 1 output/phase comparator pulse output
COMP _{IN}	3	comparator input
VCO _{OUT}	4	VCO output
INH	5	inhibit input
C1 _A	6	capacitor C1 connection A
C1 _B	7	capacitor C1 connection B
GND	8	ground (0 V) (VCO)
VCO _{IN}	9	VCO input
DEM _{OUT}	10	demodulator output
R1	11	resistor R1 connection
R2	12	resistor R2 connection
PC2 _{OUT}	13	phase comparator 2 output (current source adjustable with R _b)
SIG _{IN}	14	signal input
R _b	15	bias resistor (R _b) connection
V _{CC}	16	supply voltage

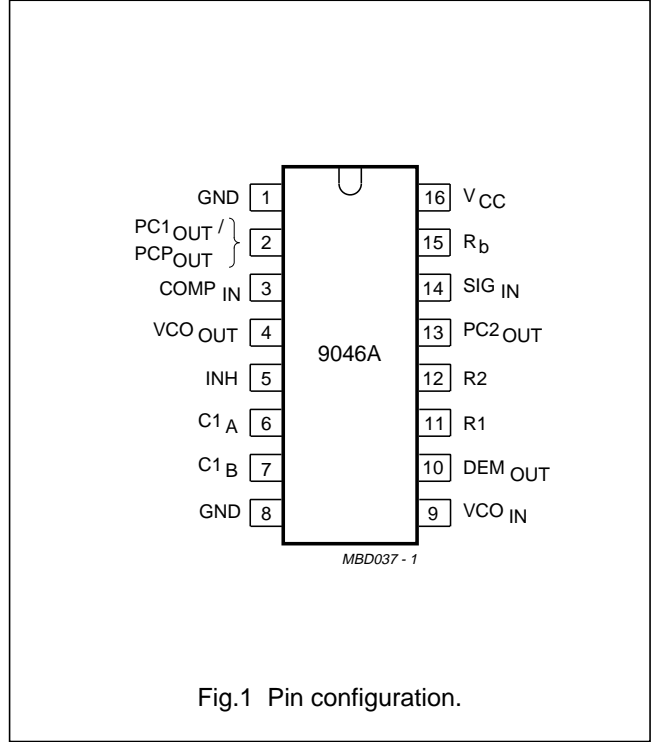

Fig.1 Pin configuration.

LOGIC/FUNCTIONAL SYMBOLS AND DIAGRAMS

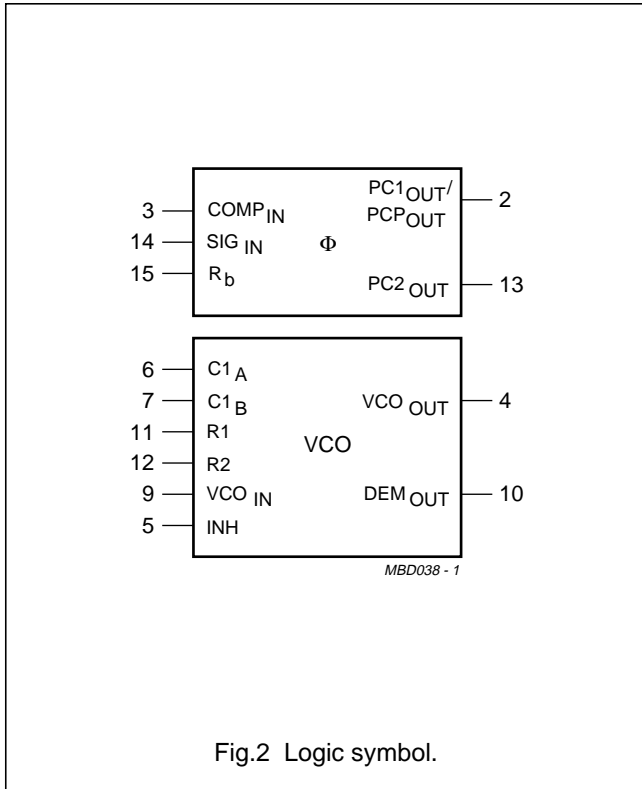

Fig.2 Logic symbol.

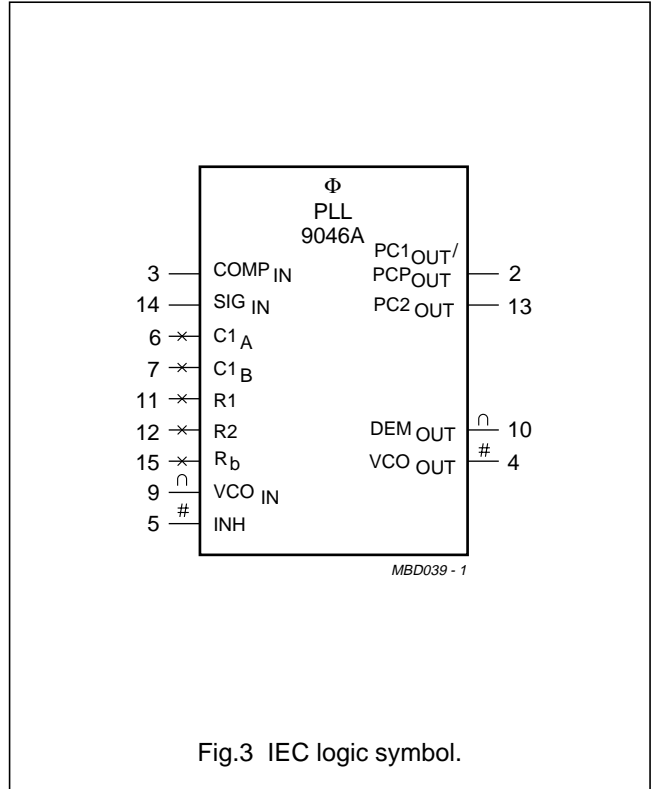

Fig.3 IEC logic symbol.

PLL with bandgap controlled VCO

74HCT9046A

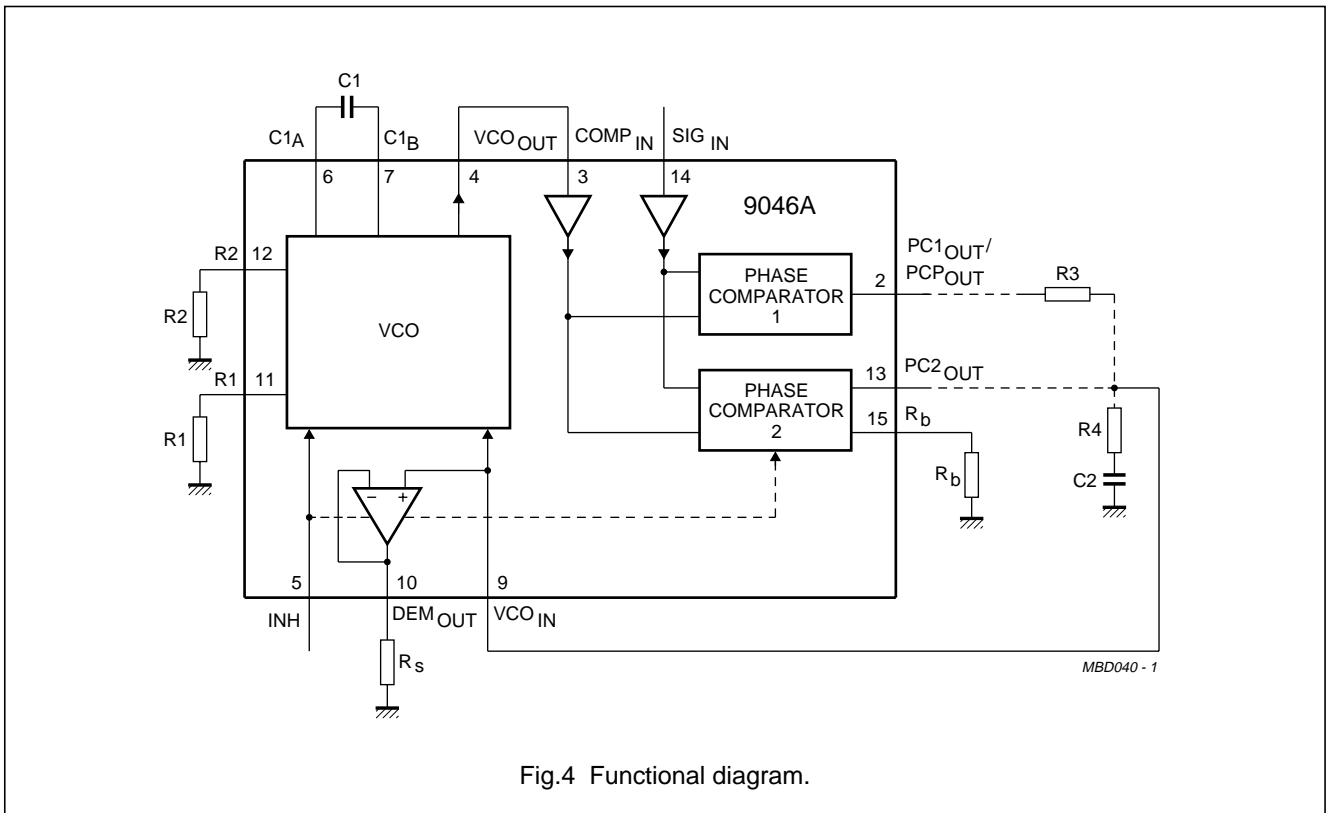

Fig.4 Functional diagram.

PLL with bandgap controlled VCO

74HCT9046A

FUNCTIONAL DESCRIPTION

The 74HCT9046A is a phase-locked-loop circuit that comprises a linear VCO and two different phase comparators (PC1 and PC2) with a common signal input amplifier and a common comparator input (see Fig.4). The signal input can be directly coupled to large voltage signals (CMOS level), or indirectly coupled (with a series capacitor) to small voltage signals. A self-bias input circuit keeps small voltage signals within the linear region of the input amplifiers. With a passive low-pass filter, the '9046A' forms a second-order loop PLL.

The principle of this phase-locked-loop is based on the familiar HCT4046A. However extra features are built in, allowing very high performance phase-locked-loop applications. This is done, at the expense of PC3, which is skipped in this HCT9046A. The PC2 is equipped with a current source output stage here. Further a bandgap is applied for all internal references, allowing a small centre frequency tolerance. The details are summed up in the next section called: "Differences with respect to the familiar HCT4046A". If one is familiar with the HCT4046A already, it will do to read this section only.

DIFFERENCES WITH RESPECT TO THE FAMILIAR HCT4046A

- A centre frequency tolerance of maximum $\pm 10\%$.
- The on board bandgap sets the internal references resulting in a minimal frequency shift at supply voltage variations and temperature variations.
- The value of the frequency offset is determined by an internal reference voltage of 2.5 V instead of $V_{CC} - 0.7$ V. In this way the offset

frequency will not shift over the supply voltage range.

- A current switch charge pump output on PC2 allows a virtually ideal performance of PC2. The gain of PC2 is independent of the voltage across the low-pass filter. Further a passive low-pass filter in the loop achieves an active performance now. The influence of the parasitic capacitance of the PC2 output plays no role here, resulting in a true correspondence of the output correction pulse and the phase difference even up to phase differences as small as a few nanoseconds.
- Because of its linear performance without dead zone, higher impedance values for the filter, hence lower C-values, can now be chosen. Correct operation will not be influenced by parasitic capacitances as in the instance with voltage source output of the 4046A.
- No PC3 on pin 15 but instead a resistor connected to GND, which sets the load/unload currents of the charge pump (PC2).
- Extra GND pin at pin 1 to allow an excellent FM demodulator performance even at 10 MHz and higher.
- Combined function of pin 2. If pin 15 is connected to V_{CC} (no bias resistor R_b) pin 2 has its familiar function viz. output of PC1. If at pin 15 a resistor (R_b) is connected to GND it is assumed that PC2 has been chosen as phase comparator. Connection of R_b is sensed by internal circuitry and this changes the function of pin 2 into a lock detect output (PCP_{OUT}) with the same characteristics as PCP_{OUT} of pin 1 of the well known 74HCT4046A.

- The inhibit function differs. For the HCT4046A a HIGH level at the inhibit input (INH) disables the VCO and demodulator, while a LOW level turns both on. For the 74HCT9046A a HIGH level on the inhibit input disables the whole circuit to minimize standby power consumption.

VCO

The VCO requires one external capacitor C1 (between $C1_A$ and $C1_B$) and one external resistor R1 (between R1 and GND) or two external resistors R1 and R2 (between R1 and GND, and R2 and GND). Resistor R1 and capacitor C1 determine the frequency range of the VCO. Resistor R2 enables the VCO to have a frequency offset if required (see Fig.5).

The high input impedance of the VCO simplifies the design of the low-pass filters by giving the designer a wide choice of resistor/capacitor ranges. In order not to load the low-pass filter, a demodulator output of the VCO input voltage is provided at pin 10 (DEM_{OUT}). The DEM_{OUT} voltage equals that of the VCO input. If DEM_{OUT} is used, a load resistor (R_s) should be connected from pin 10 to GND; if unused, DEM_{OUT} should be left open. The VCO output (VCO_{OUT}) can be connected directly to the comparator input ($COMP_{IN}$), or connected via a frequency-divider. The VCO output signal has a duty factor of 50% (maximum expected deviation 1%), if the VCO input is held at a constant DC level. A LOW level at the inhibit input (INH) enables the VCO and demodulator, while a HIGH level turns both off to minimize standby power consumption.

PLL with bandgap controlled VCO

74HCT9046A

Phase comparators

The signal input (SIG_{IN}) can be directly coupled to the self-biasing amplifier at pin 14, provided that the signal swing is between the standard HC family input logic levels. Capacitive coupling is required for signals with smaller swings.

PHASE COMPARATOR 1 (PC1)

This circuit is an EXCLUSIVE-OR network. The signal and comparator input frequencies (f_i) must have a 50% duty factor to obtain the maximum locking range. The transfer characteristic of PC1, assuming ripple ($f_r = 2f_i$) is suppressed, is:

$$V_{\text{DEMOUT}} = \frac{V_{\text{CC}}}{\pi} (\Phi_{\text{SIGIN}} - \Phi_{\text{COMPIN}})$$

where:

V_{DEMOUT} is the demodulator output at pin 10.

$V_{\text{DEMOUT}} = V_{\text{PC1OUT}}$ (via low-pass).

The phase comparator gain is:

$$K_p = \frac{V_{\text{CC}}}{\pi} (V/r)$$

The average output voltage from PC1, fed to the VCO input via the low-pass filter and seen at the demodulator output at pin 10 (V_{DEMOUT}), is the resultant of the phase differences of signals (SIG_{IN}) and the comparator input (COMP_{IN}) as shown in Fig.6. The average of V_{DEMOUT} is equal to $\frac{1}{2}V_{\text{CC}}$ when there is no signal or noise at SIG_{IN} and with this input the VCO oscillates at the centre frequency (f_c). Typical waveforms for the PC1 loop locked at f_c are shown in Fig.7. This figure also shows the actual waveforms across the VCO capacitor at pins 6 and 7 (V_{C1A} and V_{C1B}) to show the relation between these ramps and the VCO_{OUT} voltage.

The frequency capture range ($2f_c$) is defined as the frequency range of input signals on which the PLL will lock if it was initially out-of-lock. The frequency lock range ($2f_L$) is defined as the frequency range of the input signals on which the loop will stay locked if it was initially in lock. The capture range is smaller or equal to the lock range.

With PC1, the capture range depends on the low-pass filter characteristics and can be made as large as the lock range. This configuration remains locked even with very noisy input signals. Typical behaviour of this type of phase comparator is that it may lock to input frequencies close to the harmonics of the VCO centre frequency.

PHASE COMPARATOR 2 (PC2)

This is a positive edge-triggered phase and frequency detector. When the PLL is using this comparator, the loop is controlled by positive signal transitions and the duty factors of SIG_{IN} and COMP_{IN} are not important. PC2 comprises two D-type flip-flops, control gating and a 3-state output stage with sink and source transistors acting as current sources, henceforth called charge pump output of PC2. The circuit functions as an up-down counter (Fig.5) where SIG_{IN} causes an up-count and COMP_{IN} a down count. The current switch charge pump output allows a virtually ideal performance of PC2, due to appliance of some pulse overlap of the up and down signals. See Fig.8a.

PLL with bandgap controlled VCO

74HCT9046A

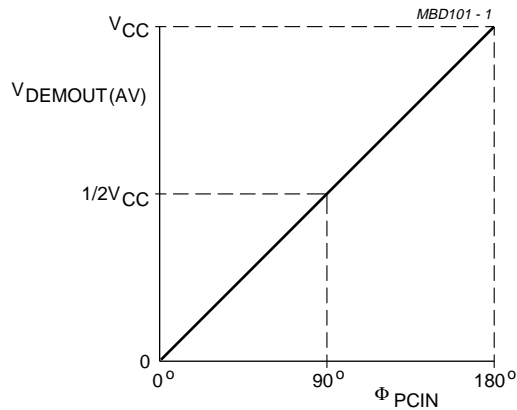

$$V_{\text{DEMOUT}} = V_{\text{PC1OUT}} = \frac{V_{\text{CC}}}{\pi} (\Phi_{\text{SIGIN}} - \Phi_{\text{COMPIN}})$$

$$\Phi_{\text{PCIN}} = (\Phi_{\text{SIGIN}} - \Phi_{\text{COMPIN}})$$

Fig.6 Phase comparator 1; average output voltage as a function of input phase difference.

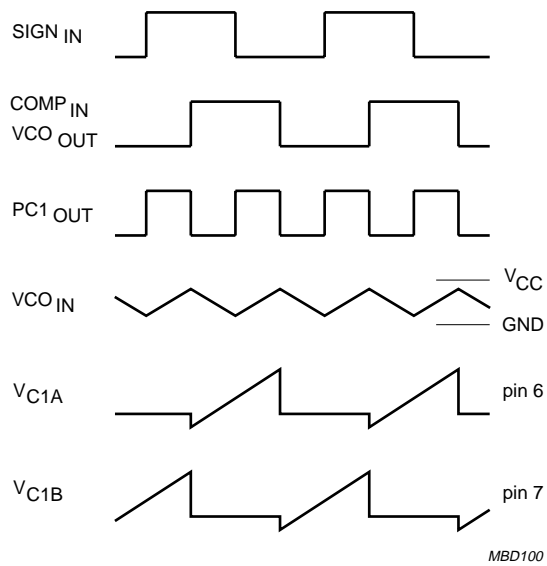

Fig.7 Typical waveforms for PLL using phase comparator 1; loop-locked at f_c .

PLL with bandgap controlled VCO

74HCT9046A

The pump current I_P is independent from the supply voltage and is set by the internal bandgap reference of 2.5 V.

$$I_P = 17 \times \frac{2.5}{R_b} \text{ (A)}$$

R_b is the external bias resistor between pin 15 and ground.

The current and voltage transfer function of PC2 are shown in Fig.9.

The phase comparator gain is:

$$K_p = \frac{|I_P|}{2\pi} \text{ (A/r)}$$

Typical waveforms for the PC2 loop locked at f_c are shown in Fig.10.

When the frequencies of SIG_{IN} and $COMP_{IN}$ are equal but the phase of SIG_{IN} leads that of $COMP_{IN}$, the up output driver at $PC2_{OUT}$ is held 'ON' for a time corresponding to the phase difference (Φ_{PCIN}). When the phase of SIG_{IN} lags that of $COMP_{IN}$, the down or sink driver is held 'ON'.

When the frequency of SIG_{IN} is higher than that of $COMP_{IN}$, the source output driver is held 'ON' for most of the input signal cycle time and for the remainder of the cycle time both drivers are 'OFF' (3-state). If the SIG_{IN} frequency is lower than the $COMP_{IN}$ frequency, then it is the sink driver that is held 'ON' for most of the cycle. Subsequently the voltage at the capacitor (C2) of the low-pass filter connected to $PC2_{OUT}$ varies until the signal and comparator inputs are equal in both phase and frequency. At this stable point the voltage on C2 remains constant as the PC2 output is in 3-state and the VCO input at pin 9 is a high impedance. Also in this condition the signal at the phase comparator pulse output (PCP_{OUT}) has a minimum output pulse width equal to the overlap time, so can be used for indicating a locked condition.

Thus for PC2 no phase difference exists between SIG_{IN} and $COMP_{IN}$ over the full frequency range of the VCO. Moreover, the power dissipation due to the low-pass filter is reduced because both output drivers are OFF for most of the signal input cycle. It should be noted that the PLL lock range for this type of phase comparator is equal to the capture range and is independent of the low-pass filter. With no signal present at SIG_{IN} the VCO adjust, via PC2, to its lowest frequency.

By using current sources as charge pump output on PC2, the dead zone or backlash time could be reduced to zero. Also, the pulse widening due to the parasitic output capacitance plays no role here. This enables a linear transfer function, even in the vicinity of the zero crossing. The differences between a voltage switch charge pump and a current switch charge pump are shown in Fig.11.

The design of the low-pass filter is somewhat different when using current sources. The external resistor R3 is no longer present when using PC2 as phase comparator. The current source is set by R_b . A simple capacitor behaves as an ideal integrator now, because the capacitor is charged by a constant current. The transfer function of the voltage switch charge pump may be used. In fact it is even more valid, because the transfer function is no longer restricted for small changes only. Further the current is independent from both the supply voltage and the voltage across the filter. For one that is familiar with the low-pass filter design of the 4046A a relation may show how R_b relates with a fictive series resistance, called R3'.

This relation can be derived by assuming first that a voltage controlled switch PC2 of the 4046A is

connected to the filter capacitance C2 via this fictive R3' (see Fig.8b). Then during the PC2 output pulse the charge current equals:

$$|I_P| = \frac{V_{CC} - V_{C2(0)}}{R3'}$$

With the initial voltage $V_{C2(0)}$ at:

$$\frac{1}{2}V_{CC} = 2.5 \text{ V}, |I_P| = \frac{2.5}{R3'}$$

As shown before the charge current of the current switch of the 9046A is:

$$|I_P| = 17 \times \frac{2.5}{R_b}$$

Hence:

$$R3' = \frac{R_b}{17} \text{ (\Omega)}$$

Using this equivalent resistance R3' for the filter design the voltage can now be expressed as a transfer function of PC2; assuming ripple ($f_r = f_i$) is suppressed, as:

$$K_{PC2} = \frac{5}{4\pi} \text{ (V/r)}$$

Again this illustrates the supply voltage independent behaviour of PC2.

Examples of PC2 combined with a passive filter are shown in Figs 12 and 13. Figure 12 shows that PC2 with only a C2 filter behaves as a high-gain filter. For stability the damped version of Fig.13 with series resistance R4 is preferred.

Practical design values for R_b are between 25 and 250 k Ω with $R3' = 1.5$ to 15 k Ω for the filter design. Higher values for R3' require lower values for the filter capacitance which is very advantageous at low values the loop natural frequency ω_n .

PLL with bandgap controlled VCO

74HCT9046A

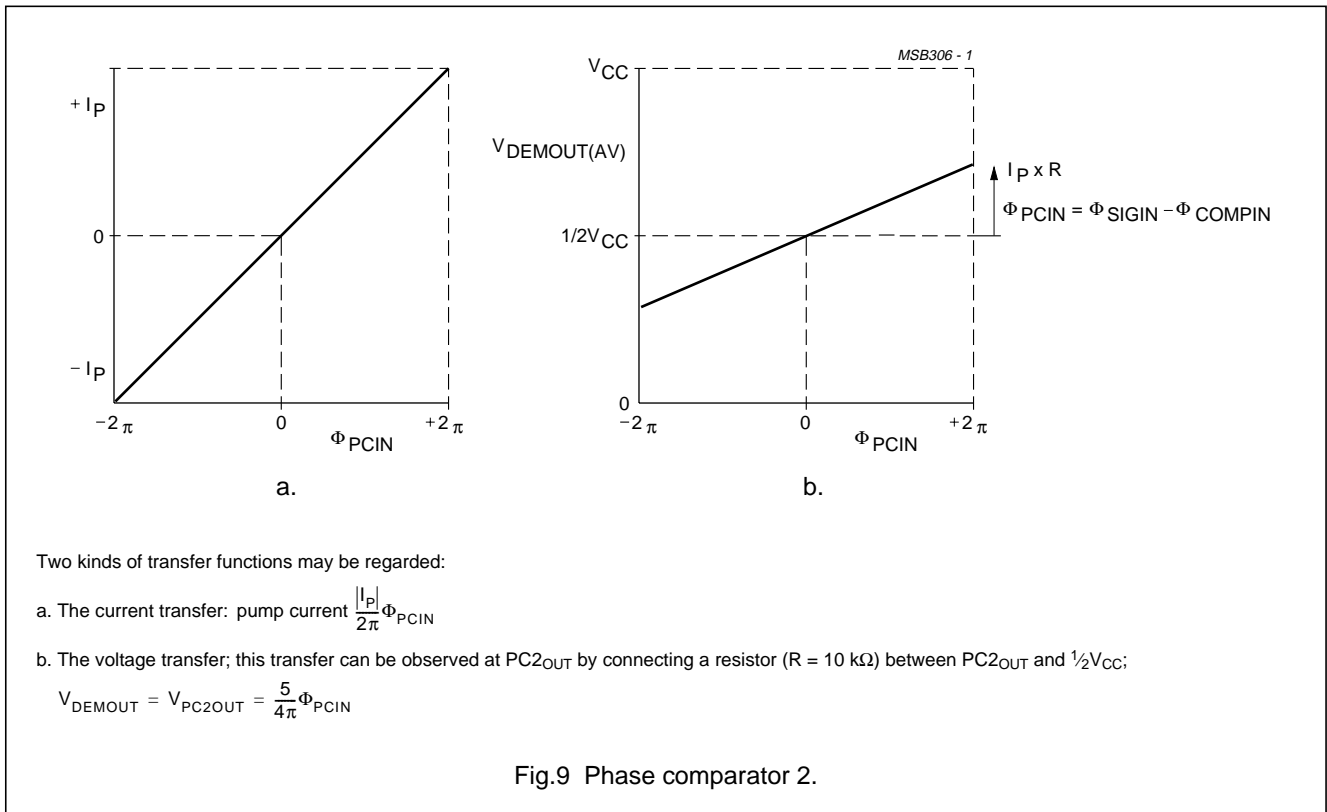
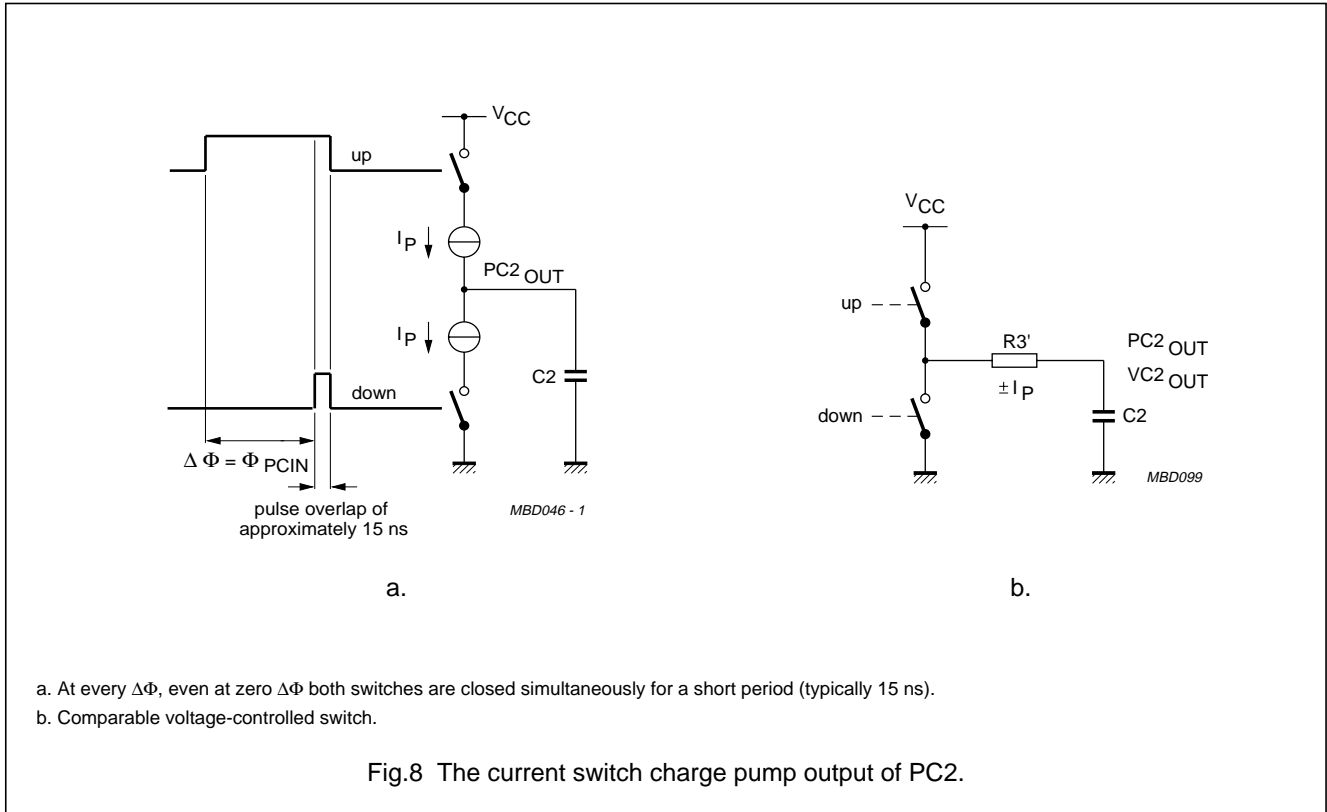

PLL with bandgap controlled VCO

74HCT9046A

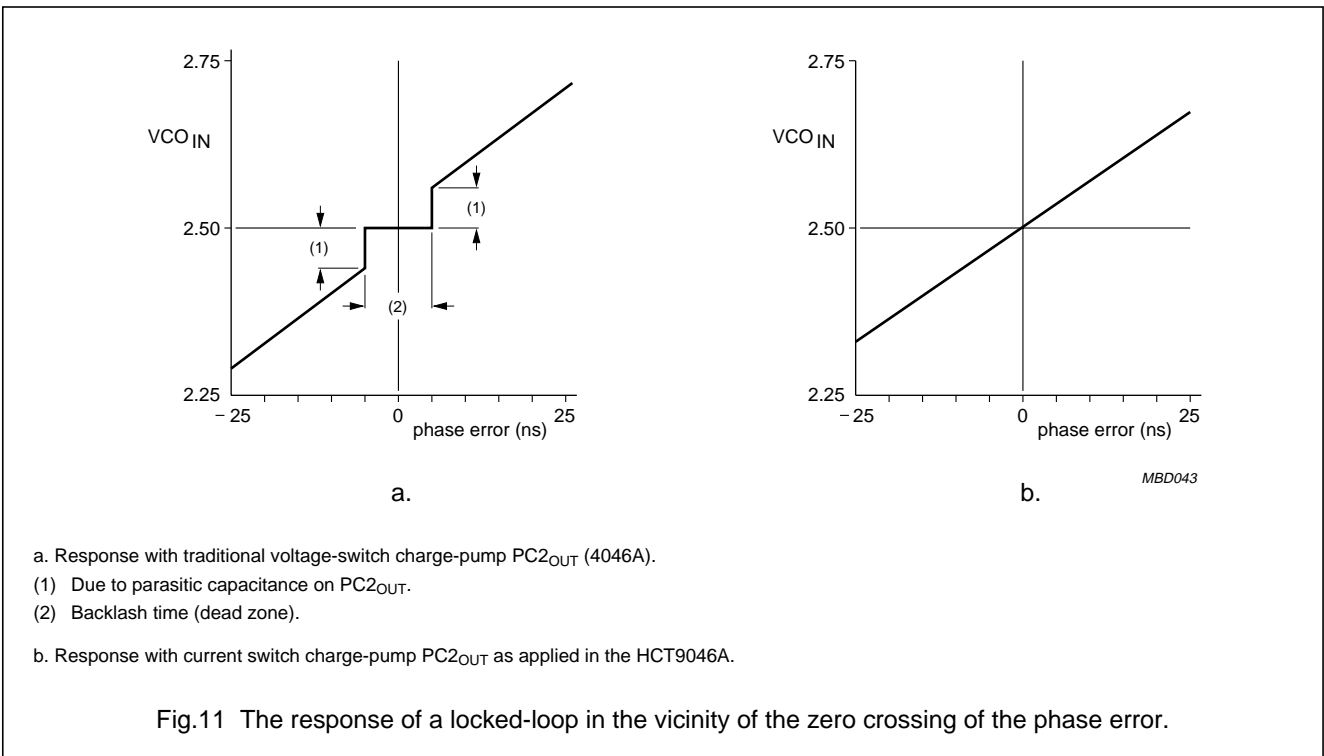
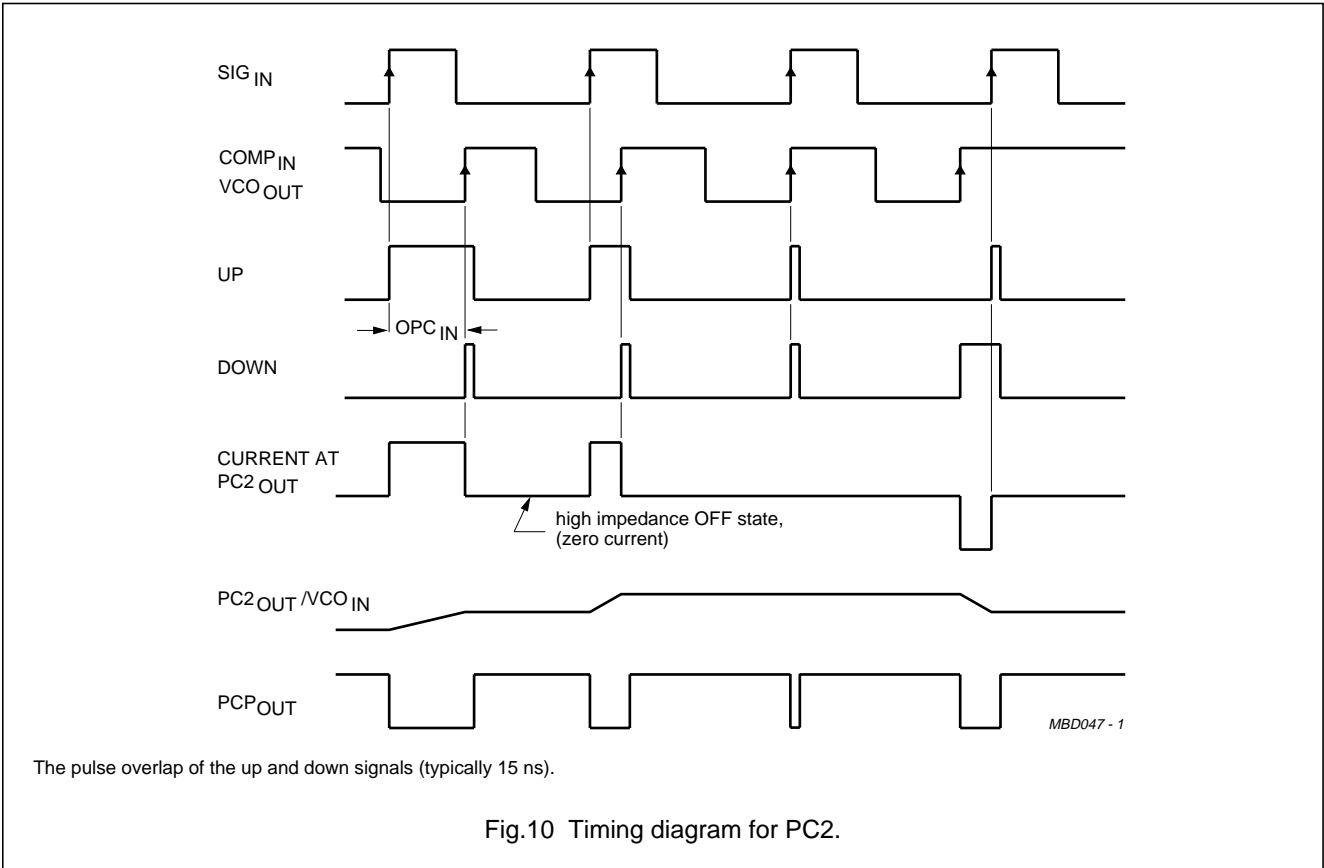

PLL with bandgap controlled VCO

74HCT9046A

LOOP FILTER COMPONENT SELECTION

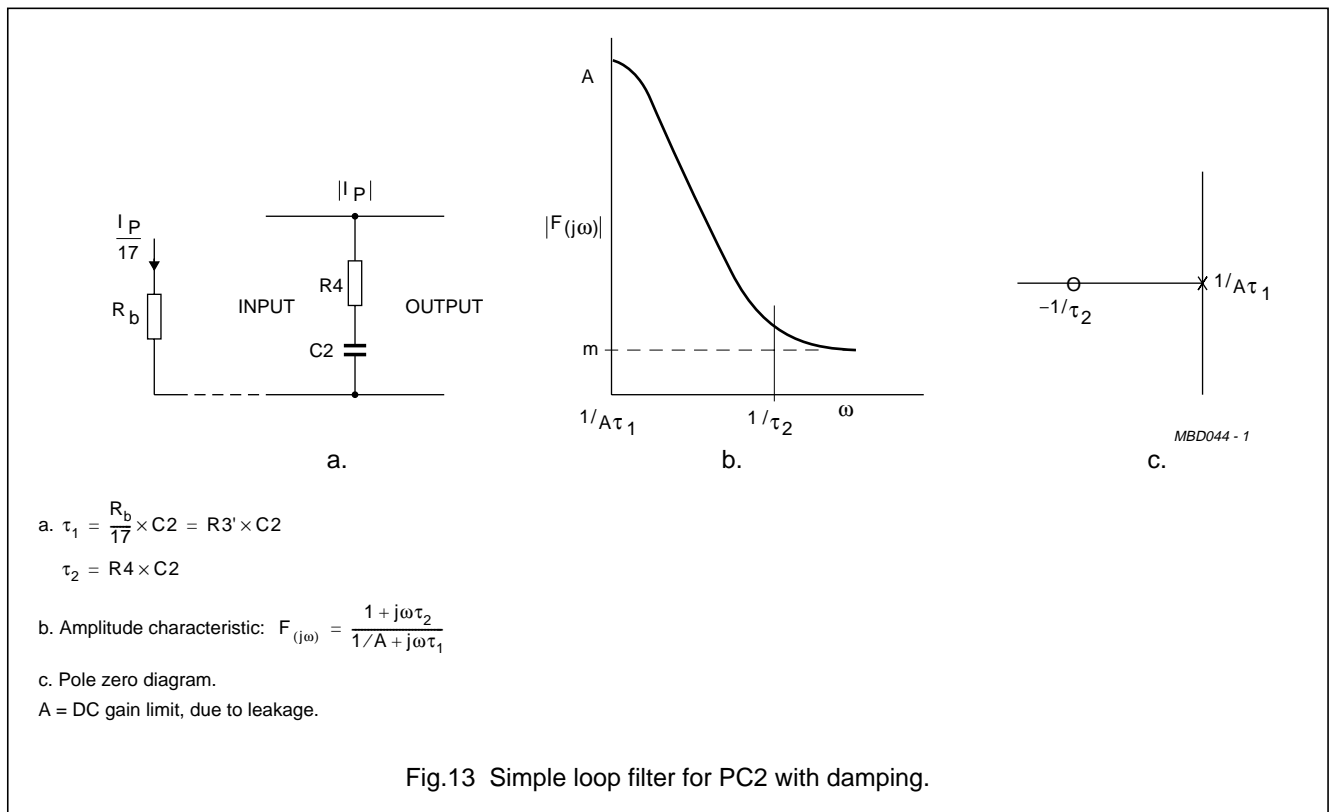
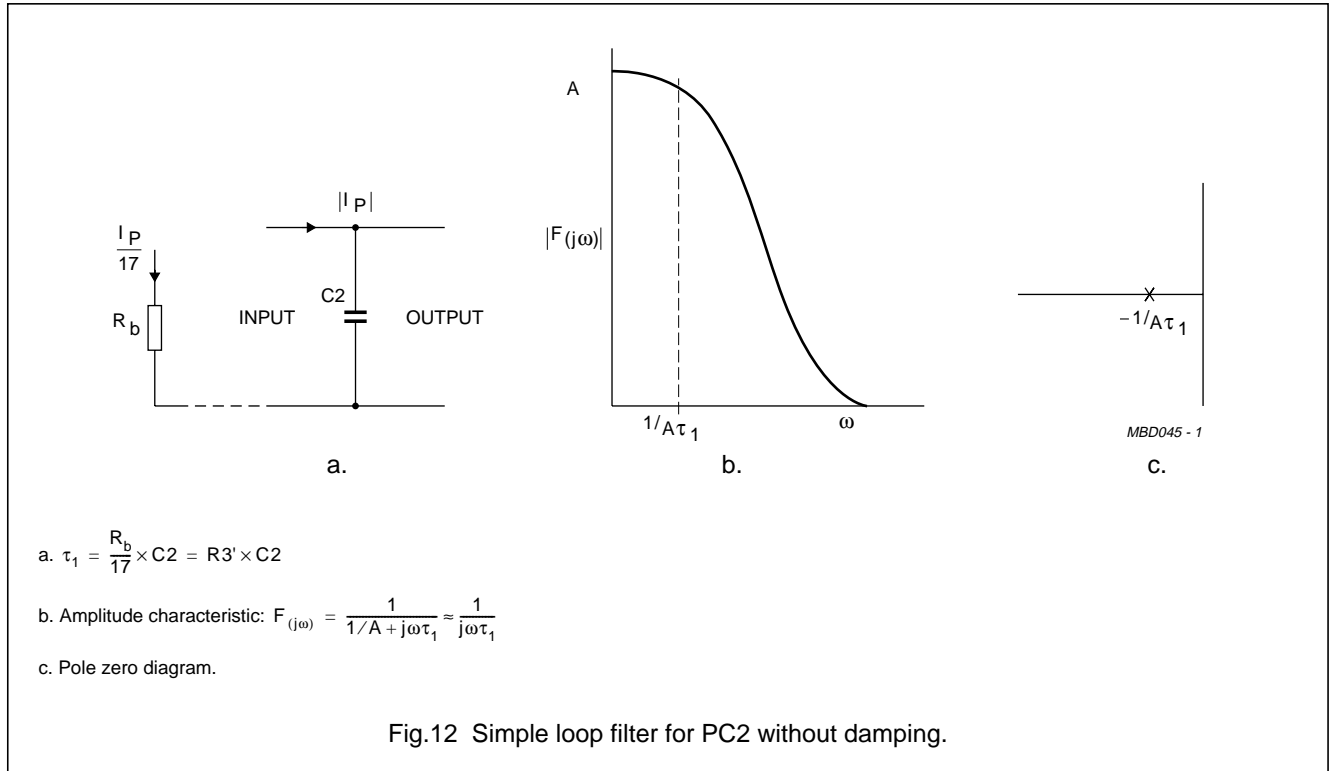

PLL with bandgap controlled VCO

74HCT9046A

RECOMMENDED OPERATING CONDITIONS FOR 74HCT

SYMBOL	PARAMETER	CONDITIONS	MIN.	TYP.	MAX.	UNIT
V_{CC}	DC supply voltage		4.5	5.0	5.5	V
V_I	DC input voltage		0	–	V_{CC}	V
V_O	DC output voltage		0	–	V_{CC}	V
T_{amb}	operating ambient temperature	see DC and AC Characteristics	–40	–	+85	°C
			–40	–	+125	°C
t_r, t_f	input rise and fall times (pin 5)	$V_{CC} = 4.5\text{ V}$	–	6	500	ns

LIMITING VALUES

In accordance with the Absolute Maximum Rating System (IEC 134); voltages are referenced to GND (ground = 0 V).

SYMBOL	PARAMETER	CONDITIONS	MIN.	MAX.	UNIT
V_{CC}	DC supply voltage		–0.5	+7	V
I_{IK}	DC input diode current	for $V_I < -0.5\text{ V}$ or $V_I > V_{CC} + 0.5\text{ V}$	–	± 20	mA
I_{OK}	DC output diode current	for $V_O < -0.5\text{ V}$ or $V_O > V_{CC} + 0.5\text{ V}$	–	± 20	mA
I_O	DC output source or sink current	for $-0.5\text{ V} < V_O < V_{CC} + 0.5\text{ V}$	–	± 25	mA
$I_{CC}; I_{GND}$	DC V_{CC} or GND current		–	± 50	mA
T_{stg}	storage temperature		–65	+150	°C
P_{tot}	total power dissipation per package	note 1	–	750	mW
	plastic DIL				
	plastic mini-pack (SO)	above +70 °C: derate linearly with 8 mW/K	–	500	mW

Note

1. Temperature range: –40 to +125 °C.

PLL with bandgap controlled VCO

74HCT9046A

DC CHARACTERISTICS FOR 74HCT

Voltages are referenced to GND (ground = 0 V).

SYMBOL	PARAMETER	T _{amb} (°C)								UNIT	TEST CONDITIONS		
		+25			-40 to +85		-40 to +125		V _{CC} (V)		V _I (V)	OTHER	
		MIN.	TYP.	MAX.	MIN.	MAX.	MIN.	MAX.					
Phase comparator section													
V _{IH}	DC coupled HIGH level input voltage SIG _{IN} , COMP _{IN}	3.15	2.4	–	3.15	–	3.15	–	V	4.5	–		
V _{IL}	DC coupled LOW level input voltage SIG _{IN} , COMP _{IN}	–	2.1	1.35	–	1.35	–	1.35	V	4.5	–		
V _{OH}	HIGH level output voltage PCP _{OUT} , PCn _{OUT}	4.4	4.5	–	4.4	–	4.4	–	V	4.5	V _{IH} or V _{IL}	I _O = –20 µA	
		3.98	4.32	–	3.84	–	3.7	–	V	4.5	V _{IH} or V _{IL}	I _O = –4.0 mA	
V _{OL}	LOW level output voltage PCP _{OUT} , PCn _{OUT}	–	0	0.1	–	0.1	–	0.1	V	4.5	V _{IH} or V _{IL}	I _O = –20 µA	
		–	0.15	0.26	–	0.33	–	0.4	V	4.5	V _{IH} or V _{IL}	I _O = –4.0 mA	
I _I	input leakage current SIG _{IN} , COMP _{IN}	–	–	±30	–	±38	–	±45	µA	5.5	V _{CC} or GND		
I _{OZ}	3-state OFF-state current PC2 _{OUT}	–	–	±0.5	–	±5.0	–	±10.0	µA	5.5	V _{IH} or V _{IL}	V _O = V _{CC} or GND	
R _I	input resistance SIG _{IN} , COMP _{IN}	–	250	–	–	–	–	–	kΩ	4.5	V _I at self-bias operating point; ΔV _I = 0.5 V; see Figs 14 to 16		
R _b	bias resistance	25	–	250	–	–	–	–	kΩ	4.5	–		
I _p	charge pump current	±0.53	±1.06	±2.12	–	–	–	–	mA	4.5	–	R _b = 40 kΩ	

PLL with bandgap controlled VCO

74HCT9046A

SYMBOL	PARAMETER	T _{amb} (°C)							UNIT	TEST CONDITIONS		
		+25			-40 to +85		-40 to +125			V _{CC} (V)	V _I (V)	OTHER
		MIN.	TYP.	MAX.	MIN.	MAX.	MIN.	MAX.				
VCO section												
V _{IH}	DC coupled HIGH level input voltage INH	2.0	1.6	–	2.0	–	2.0	–	V	4.5 to 5.5	–	
V _{IL}	DC coupled LOW level input voltage INH	–	1.2	0.8	–	0.8	–	0.8	V	4.5 to 5.5	–	
V _{OH}	HIGH level output voltage VCO _{OUT}	4.4	4.5	–	4.4	–	4.4	–	V	4.5	V _{IH} or V _{IL}	I _O = –20 µA
		3.98	4.32	–	3.84	–	3.7	–	V	4.5	V _{IH} or V _{IL}	I _O = –4.0 mA
V _{OL}	LOW level output voltage VCO _{OUT}	–	0	0.1	–	0.1	–	0.1	V	4.5	V _{IH} or V _{IL}	I _O = 20 µA
		–	0.15	0.26	–	0.33	–	0.4	V	4.5	V _{IH} or V _{IL}	I _O = 4.0 mA
V _{OL}	LOW level output voltage C1 _A , C1 _B	–	–	0.40	–	0.47	–	0.54	V	4.5	V _{IH} or V _{IL}	I _O = 4.0 mA
I _I	input leakage current INH and VCO _{IN}	–	–	±0.1	–	±1.0	–	±1.0	µA	5.5	V _{CC} or GND	
R1	resistance	3	–	300	–	–	–	–	kΩ	4.5	–	
R2	resistance	3	–	300	–	–	–	–	kΩ	4.5	–	
C1	capacitance	40	–	no limit	–	–	–	–	pF	4.5	–	
V _{VCOIN}	operating voltage range at VCO _{IN}	1.1	–	3.4	–	–	–	–	V	4.5	–	over the range specified for R1
		1.1	–	3.9	–	–	–	–	V	5.0	–	
		1.1	–	4.4	–	–	–	–	V	5.5	–	

PLL with bandgap controlled VCO

74HCT9046A

SYMBOL	PARAMETER	T _{amb} (°C)							UNIT	TEST CONDITIONS		
		+25			-40 to +85		-40 to +125			V _{CC} (V)	V _I (V)	OTHER
		MIN.	TYP.	MAX.	MIN.	MAX.	MIN.	MAX.				
Demodulator section												
R _s	resistance	50	–	300	–	–	–	–	kΩ	4.5	–	at R _s > 300 kΩ the leakage current can influence V _{DEMOUT}
V _{OFF}	offset voltage VCO _{IN} to V _{DEMOUT}	–	±20	–	–	–	–	–	mV	4.5	–	V _I = V _{VCOIN} = 1/2 V _{CC} ; values taken over R _s range, see Fig.17
R _D	dynamic output resistance at DEM _{OUT}	–	25	–	–	–	–	–	Ω	4.5	–	V _{DEMOUT} = 1/2 V _{CC}
Quiescent supply current												
I _{CC}	quiescent supply current (disabled)	–	–	8.0	–	80.0	–	160.0	μA	5.5	–	pin 5 at V _{CC}
ΔI _{CC}	additional quiescent supply current per input pin for unit load coefficient is 1; note 1; V _I = V _{CC} – 2.1 V	–	100	360	–	450	–	490	μA	4.5	–	other inputs at V _{CC} or GND

Note

1. The value of additional quiescent supply current (ΔI_{CC}) for a unit load of 1 is given above. To determine ΔI_{CC} per input, multiply this value by the unit load coefficient shown in Table 1.

Table 1 Unit load coefficient table.

INPUT	UNIT LOAD COEFFICIENT
INH	1.00

PLL with bandgap controlled VCO

74HCT9046A

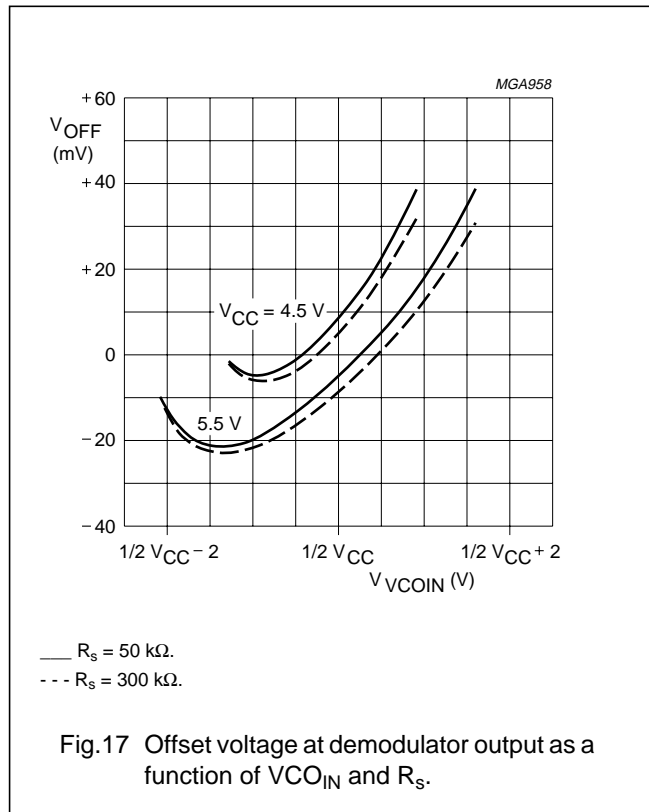
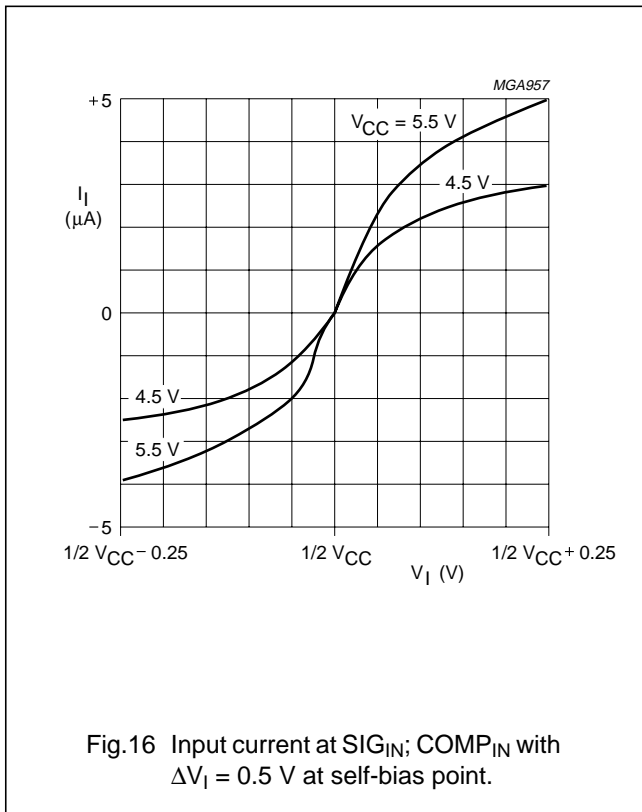
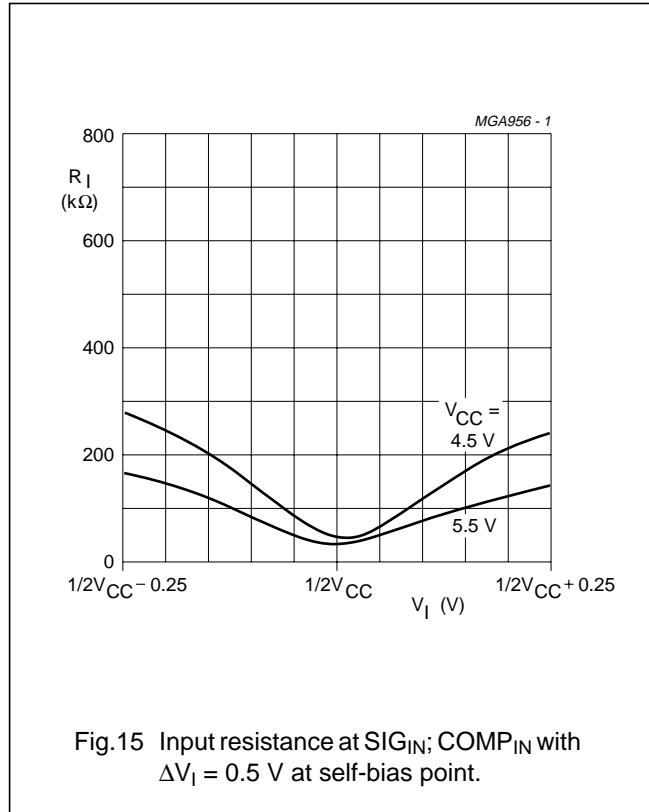
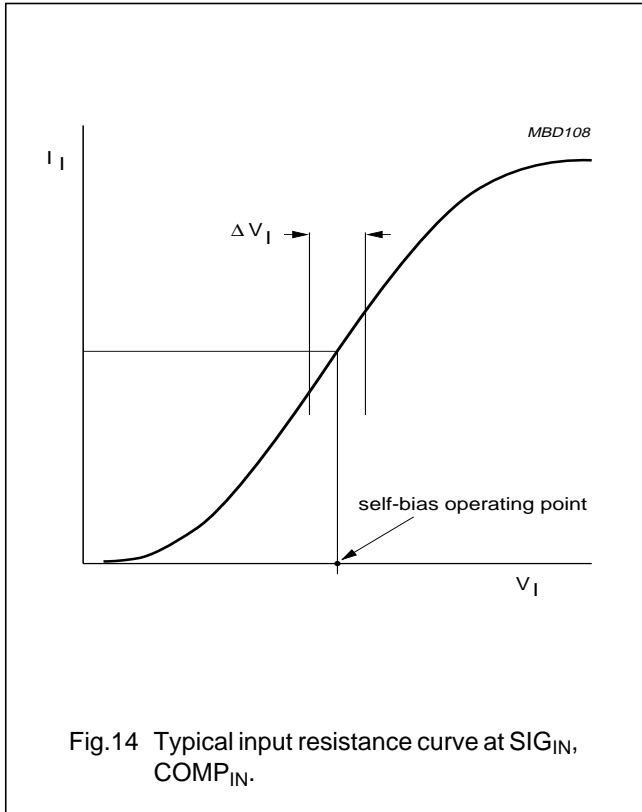

PLL with bandgap controlled VCO

74HCT9046A

AC CHARACTERISTICS FOR 74HCT

GND = 0 V; $t_r = t_f = 6$ ns; $C_L = 50$ pF.

SYMBOL	PARAMETER	T _{amb} (°C)							UNIT	TEST CONDITION	
		+25			-40 to +85		-40 to +125			V _{CC} (V)	WAVEFORMS
		MIN.	TYP.	MAX.	MIN.	MAX.	MIN.	MAX.			
Phase comparator section											
t _{PHL} /t _{PLH}	propagation delay SIG _{IN} , COMP _{IN} to PC1 _{OUT}	–	23	40	–	50	–	60	ns	4.5	Fig.18
t _{PHL} /t _{PLH}	propagation delay SIG _{IN} , COMP _{IN} to PCP _{OUT}	–	35	68	–	85	–	102	ns	4.5	Fig.18
t _{PZH} /t _{PZL}	3–state output enable time SIG _{IN} , COMP _{IN} to PC2 _{OUT}	–	30	56	–	70	–	84	ns	4.5	Fig.19
t _{PHZ} /t _{PLZ}	3–state output enable time SIG _{IN} , COMP _{IN} to PC2 _{OUT}	–	36	65	–	81	–	98	ns	4.5	Fig.19
t _{THL} /t _{TLH}	output transition time	–	7	15	–	19	–	22	ns	4.5	Fig.18
V _{i(p-p)}	AC coupled input sensitivity (peak-to-peak value) at SIG _{IN} or COMP _{IN}	–	15	–	–	–	–	–	mV	4.5	f _i = 1 MHz

PLL with bandgap controlled VCO

74HCT9046A

SYMBOL	PARAMETER	T _{amb} (°C)							UNIT	TEST CONDITION	
		+25			-40 to +85		-40 to +125			V _{CC} (V)	WAVEFORMS
		MIN.	TYP.	MAX.	MIN.	MAX.	MIN.	MAX.			
VCO section											
Δf/T	frequency stability with temperature change	–	–	–	0.06	–	–	–	%/K	4.5	V _{VCOIN} = 1/2 V _{CC} ; recommended range: R1 = 10 kΩ; R2 = 10 kΩ; C1 = 1 nF; Figs 20 to 22
Δf _c	centre frequency tolerance	–10	–	+10	–	–	–	–	%	5.0	V _{VCOIN} = 3.9 V; R1 = 10 kΩ; R2 = 10 kΩ; C1 = 1 nF
f _c	VCO centre frequency (duty factor = 50%)	11.0	15.0	–	–	–	–	–	MHz	4.5	V _{VCOIN} = 1/2 V _{CC} ; R1 = 4.3 kΩ; R2 = ∞; C1 = 40 pF; Figs 23 and 31
Δf _{VCO}	VCO frequency linearity	–	0.4	–	–	–	–	–	%	4.5	R1 = 100 kΩ; R2 = ∞; C1 = 100 pF; Figs 24 and 25
δ _{VCO}	duty factor at VCO _{OUT}	–	50	–	–	–	–	–	%	4.5	

PLL with bandgap controlled VCO

74HCT9046A

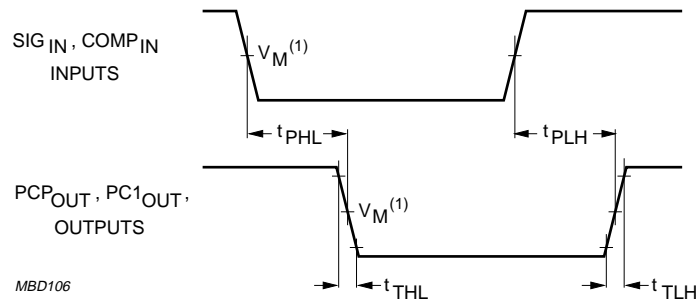

(1) $V_M = \frac{1}{2}V_{CC}$; $V_I = \text{GND to } V_{CC}$.

Fig.18 Waveforms showing input (SIG_IN and COMP_IN) to output (PCP_OUT and PC1_OUT) propagation delays and the output transition times.

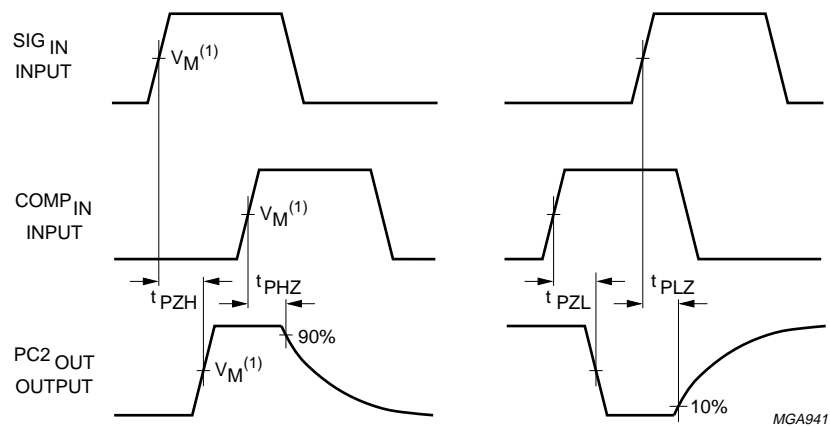

(1) $V_M = \frac{1}{2}V_{CC}$; $V_I = \text{GND to } V_{CC}$.

Fig.19 Waveforms showing the 3-state enable and disable times for PC2_OUT.

PLL with bandgap controlled VCO

74HCT9046A

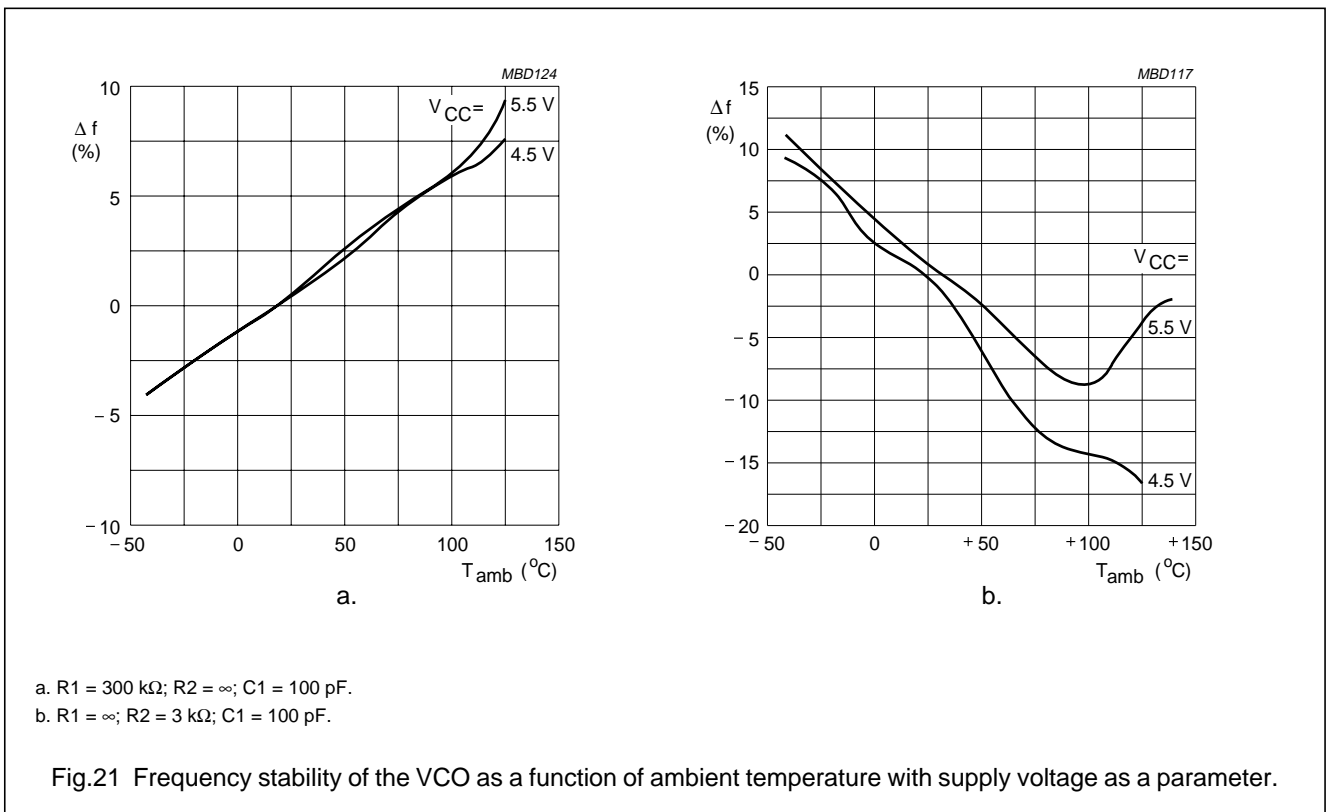
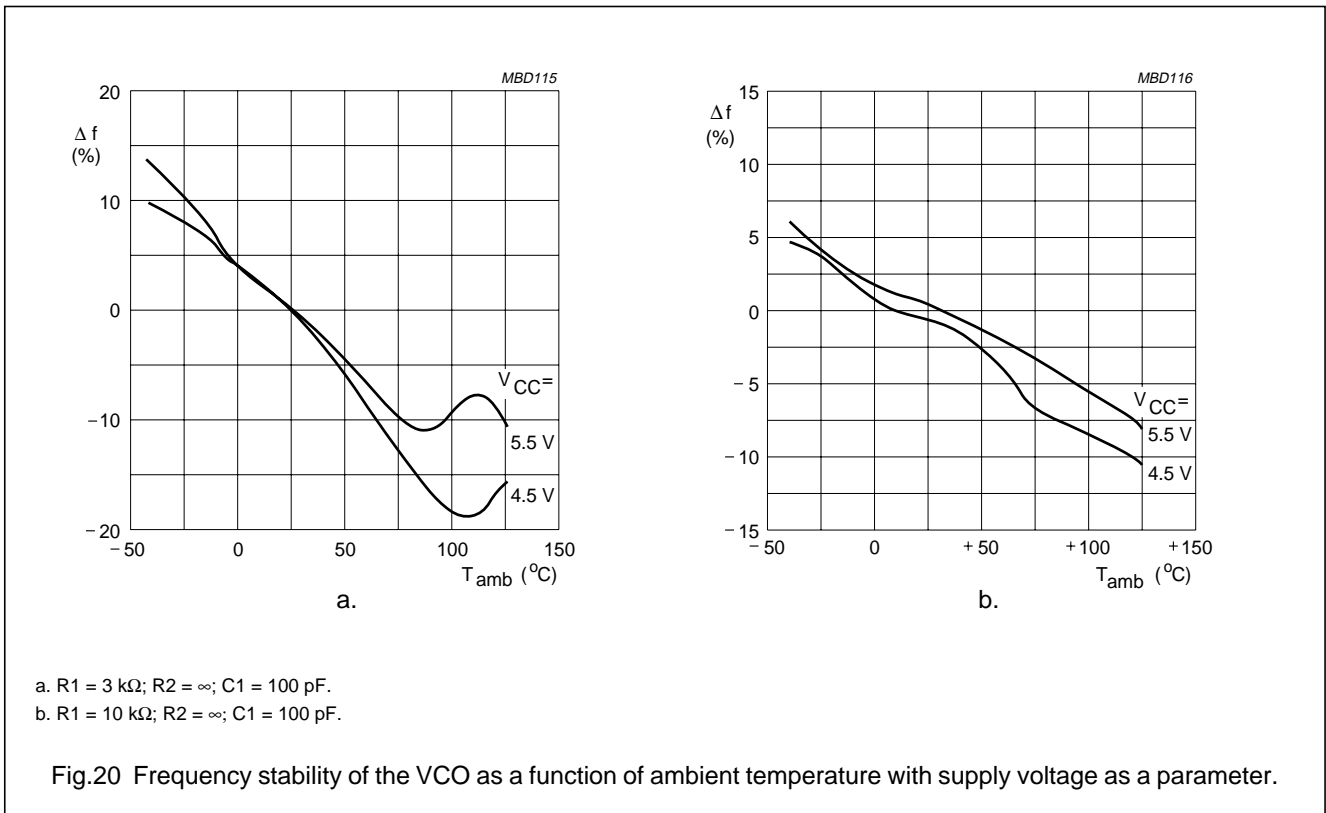

PLL with bandgap controlled VCO

74HCT9046A

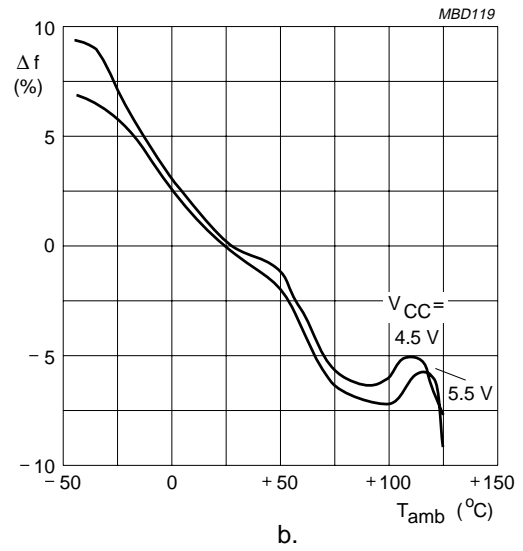
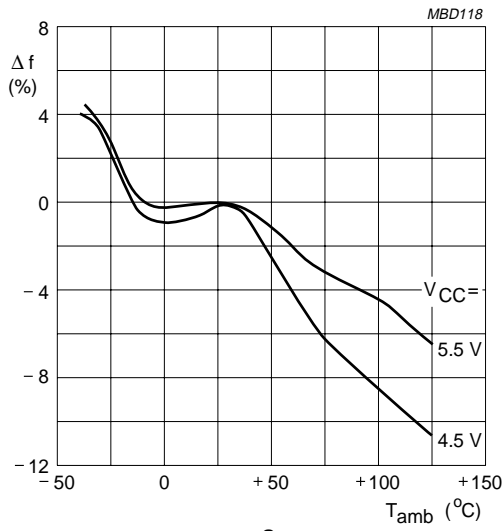

- a. $R1 = \infty$; $R2 = 10 \text{ k}\Omega$; $C1 = 100 \text{ pF}$.
- b. $R1 = \infty$; $R2 = 300 \text{ k}\Omega$; $C1 = 100 \text{ pF}$.

Fig.22 Frequency stability of the VCO as a function of ambient temperature with supply voltage as a parameter.

PLL with bandgap controlled VCO

74HCT9046A

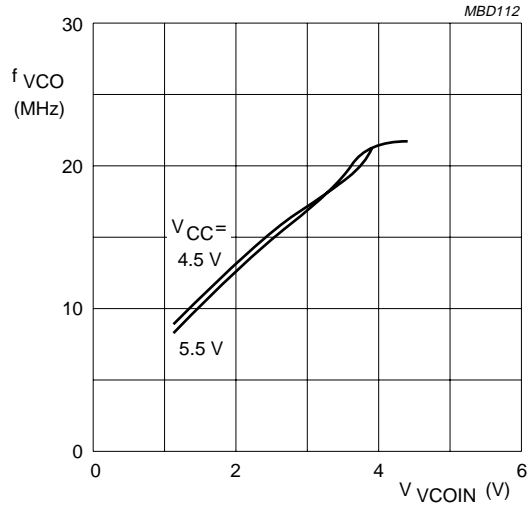

a.

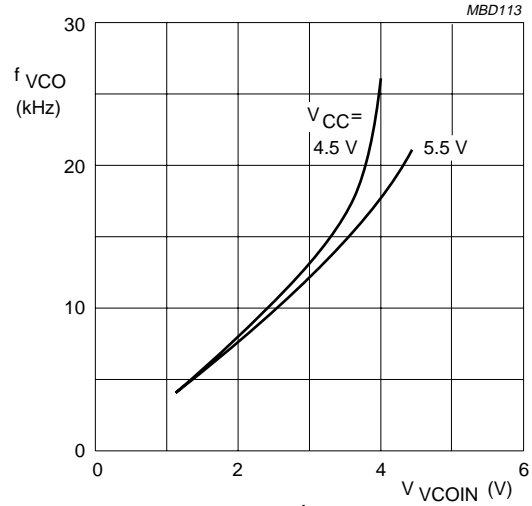

b.

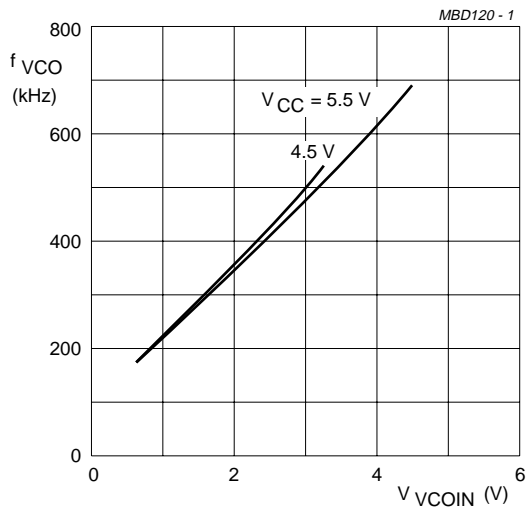

c.

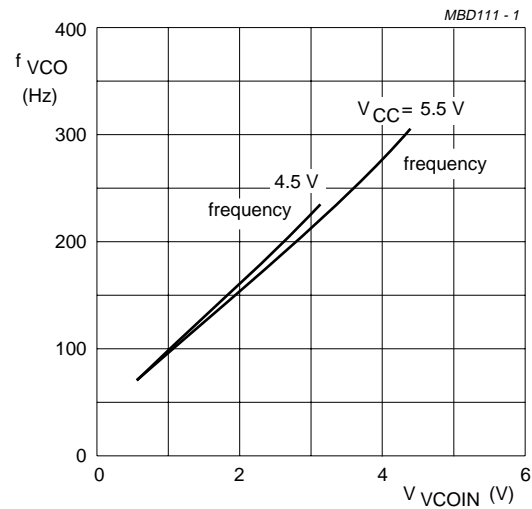

d.

- a. R1 = 4.3 kΩ; C1 = 39 pF.
- b. R1 = 4.3 kΩ; C1 = 100 nF.
- c. R1 = 300 kΩ; C1 = 39 pF.
- d. R1 = 300 kΩ; C1 = 100 nF.

Fig.23 Graphs showing VCO frequency as a function of the VCO input voltage (V_{VCOIN}).

PLL with bandgap controlled VCO

74HCT9046A

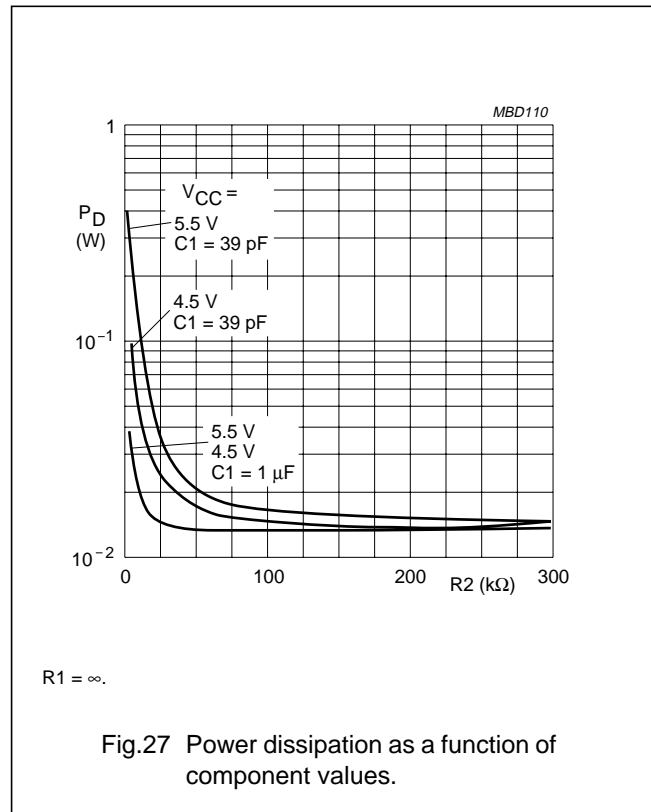
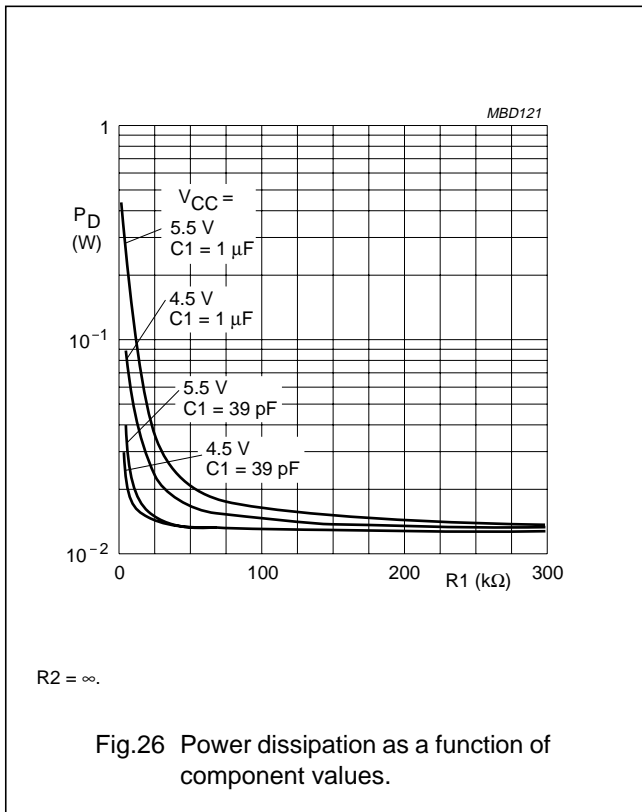
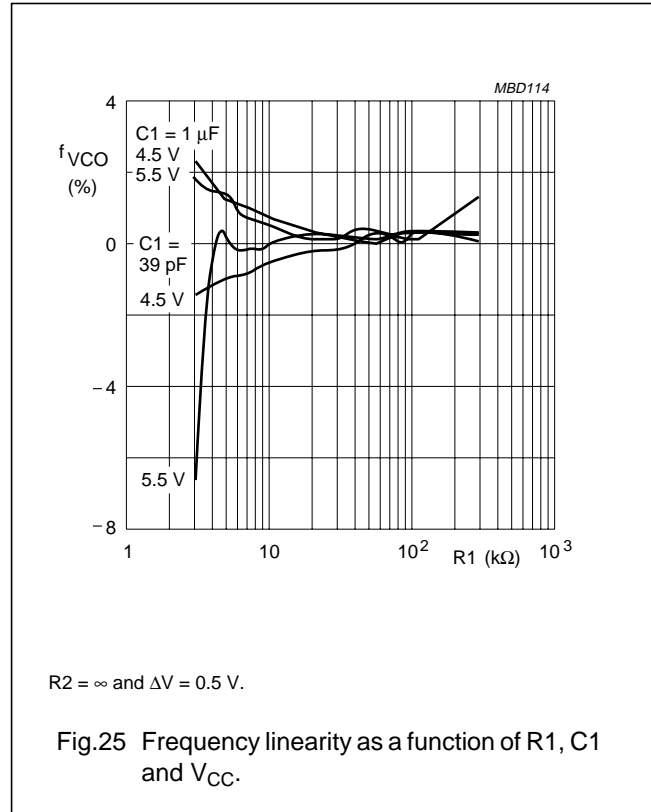
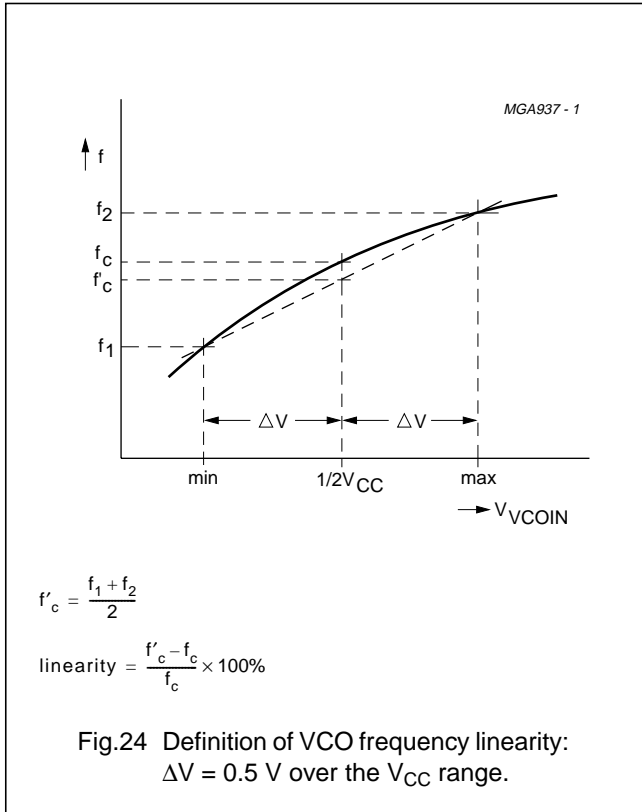

PLL with bandgap controlled VCO

74HCT9046A

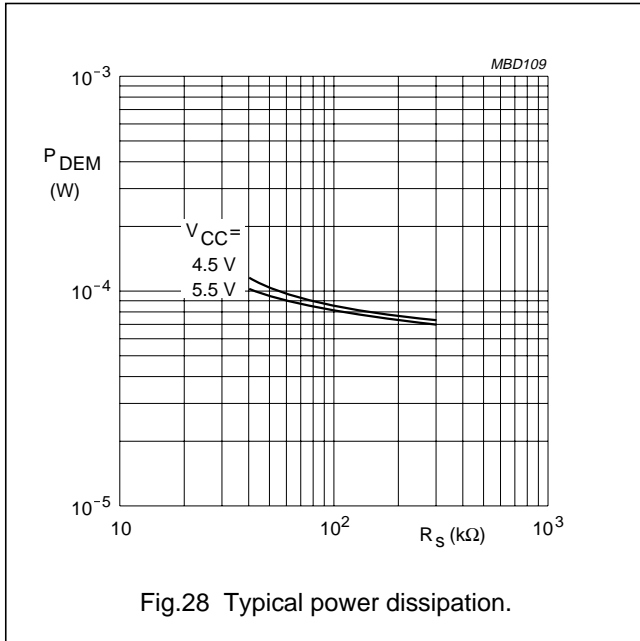

Fig.28 Typical power dissipation.

APPLICATION INFORMATION

This information is a guide for the approximation of values of external components to be used with the 74HCT9046A in a phase-locked-loop system.

Values of the selected components should be within the ranges shown in Table 2.

Table 2 Survey of components.

COMPONENT	VALUE
R1	between 3 kΩ and 300 kΩ
R2	between 3 kΩ and 300 kΩ
R1 + R2	parallel value >2.7 kΩ
C1	>40 pF

Table 3 Design considerations for VCO section.

SUBJECT	PHASE COMPARATOR	DESIGN CONSIDERATION
VCO frequency without extra offset	PC1, PC2	VCO frequency characteristic With $R2 = \infty$ and $R1$ within the range $3\text{ k}\Omega < R1 < 300\text{ k}\Omega$, the characteristics of the VCO operation will be as shown in Fig.29a. (Due to $R1$, $C1$ time constant a small offset remains when $R2 = \infty$).
	PC1	Selection of R1 and C1 Given f_c , determine the values of $R1$ and $C1$ using Fig.31.
	PC2	Given f_{max} and f_c determine the values of $R1$ and $C1$ using Fig.31; use Fig.33 to obtain $2f_L$ and then use this to calculate f_{min} .
VCO frequency with extra offset	PC1, PC2	VCO frequency characteristic With $R1$ and $R2$ within the ranges $3\text{ k}\Omega < R1 < 300\text{ k}\Omega < R2 < 300\text{ k}\Omega$, the characteristics of the VCO operation is as shown in Fig.29b.
	PC1, PC2	Selection of R1, R2 and C1 Given f_c and f_L determine the value of product $R1C1$ by using Fig.33. Calculate f_{off} from the equation $f_{off} = f_c - 1.6f_L$. Obtain the values of $C1$ and $R2$ by using Fig.32. Calculate the value of $R1$ from the value of $C1$ and the product $R1C1$.
PLL conditions with no signal at the SIG _{IN} input	PC1	VCO adjusts to f_c with $\Phi_{PCIN} = 90^\circ$ and $V_{VCOIN} = \frac{1}{2}V_{CC}$.
	PC2	VCO adjusts to f_{offset} with $\Phi_{PCIN} = -360^\circ$ and $V_{VCOIN} = \text{minimum}$.

PLL with bandgap controlled VCO

74HCT9046A

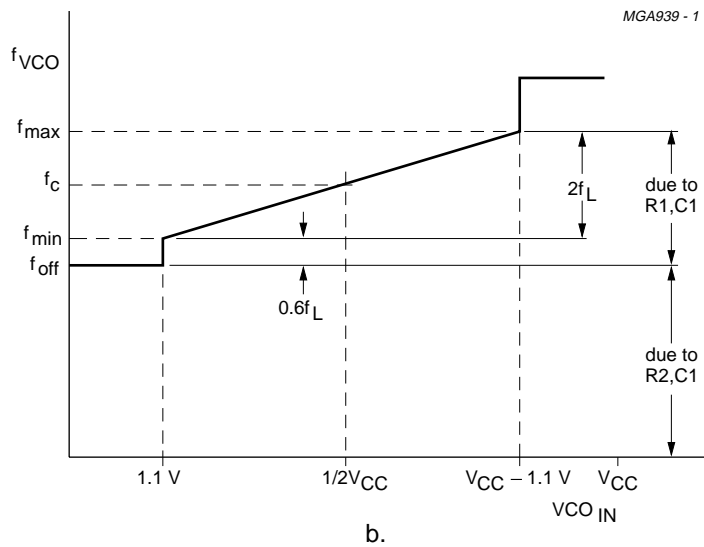
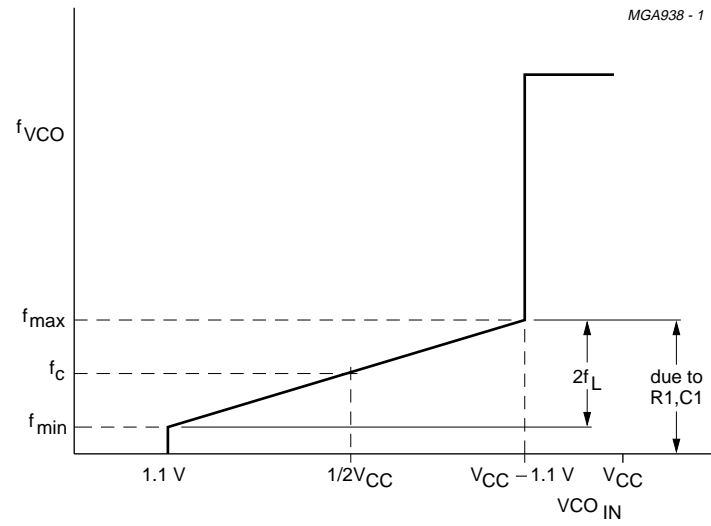

- a. Operating without offset; f_c = centre frequency; $2f_L$ = frequency lock range.
- b. Operating with offset; f_c = centre frequency; $2f_L$ = frequency lock range.

Fig.29 Frequency characteristic of VCO.

PLL with bandgap controlled VCO

74HCT9046A

Filter design considerations for PC1 and PC2 of the HCT9046A

Figure 30 shows some examples of passive and active filters to be used with the phase comparators of the HCT9046A. Transfer functions of phase comparators and filters are given in Table 4.

Table 4 Transfer functions of phase comparators and filters.

PHASE COMPARATOR	Fig.30	FILTER TYPE	TRANSFER FUNCTION	EXPLANATION
PC1	a.	passive filter without damping	$F_{(j\omega)} = \frac{1}{1 + j\omega\tau_1}$	$K_{PC1} = \frac{V_{CC}}{\pi} V/r$ $\tau_1 = R3 \times C2$; $\tau_2 = R4 \times C2$; $\tau_3 = R4 \times C3$; $A = 10^5 = \text{DC gain amplitude}$
	b.	passive filter with damping	$F_{(j\omega)} = \frac{1 + j\omega\tau_2}{1 + j\omega(\tau_1 + \tau_2)}$	
	c.	active filter with damping	$F_{(j\omega)} = \frac{1 + j\omega\tau_2}{1/A + j\omega\tau_1} \approx \frac{1 + j\omega\tau_2}{j\omega\tau_1}$	
PC2	d.	passive filter with damping	$F_{(j\omega)} = \frac{1 + j\omega\tau_2}{1/A + j\omega\tau_1} \approx \frac{1 + j\omega\tau_2}{j\omega\tau_1}$ $A = 10^5 = \text{limit DC gain}$	$K_{PC2} = \frac{5}{4\pi} V/r$ $\tau_1 = R3' \times C2$; $\tau_2 = R4 \times C2$; $\tau_3 = R4 \times C3$; $R3' = R_b/17$; $R_b = 25 \text{ to } 250 \text{ k}\Omega$
	e.	active filter with damping	$F_{(j\omega)} = \frac{1 + j\omega\tau_2}{1/A + j\omega\tau_1} \approx \frac{1 + j\omega\tau_2}{j\omega\tau_1}$ $A = 10^5 = \text{DC gain amplitude}$	

PLL with bandgap controlled VCO

74HCT9046A

PC1

CIRCUIT

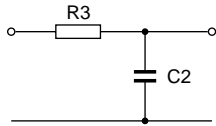

AMPLITUDE CHARACTERISTIC

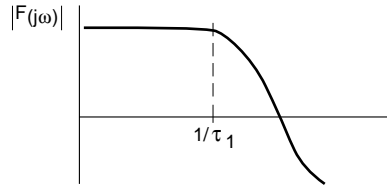

a.

POLE ZERO DIAGRAM

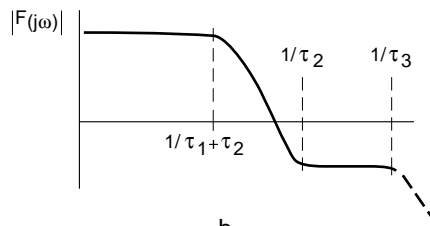
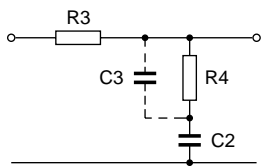
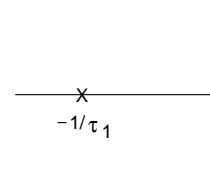

b.

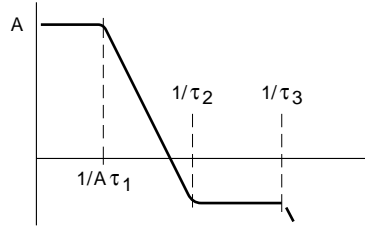
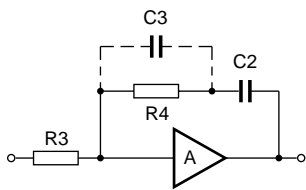
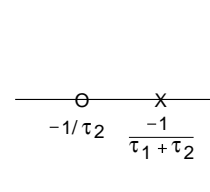

c.

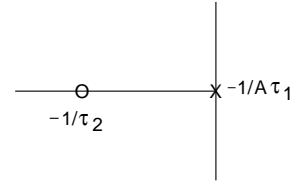

PC2

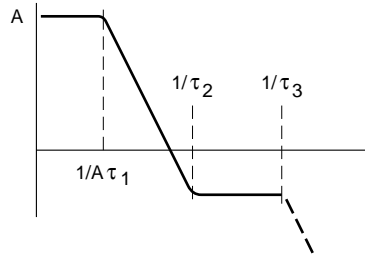
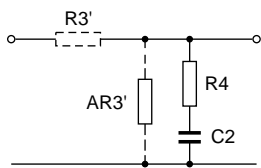

d.

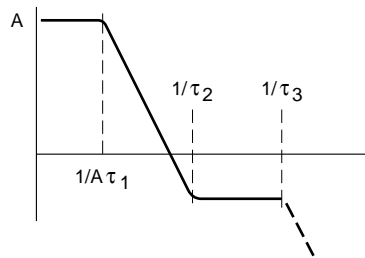
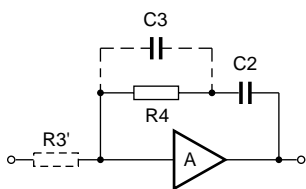
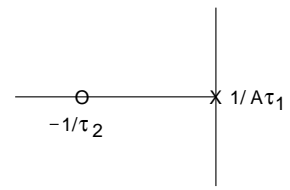

e.

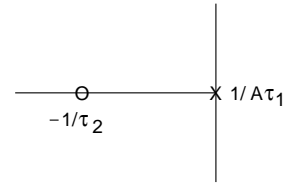

MBD107-1

Fig.30 Passive and active filters for HCT9046A.

PLL with bandgap controlled VCO

74HCT9046A

General design consideration.

SUBJECT	PHASE COMPARATOR	DESIGN CONSIDERATION
PLL locks on harmonics at centre frequency	PC1	yes
	PC2	no
Noise rejection at signal input	PC1	high
	PC2	low
AC ripple content when PLL is locked	PC1	$f_r = 2f_i$; large ripple content at $\Phi_{PCIN} = 90^\circ$
	PC2	$f_r = f_i$; small ripple content at $\Phi_{PCIN} = 0^\circ$

PLL with bandgap controlled VCO

74HCT9046A

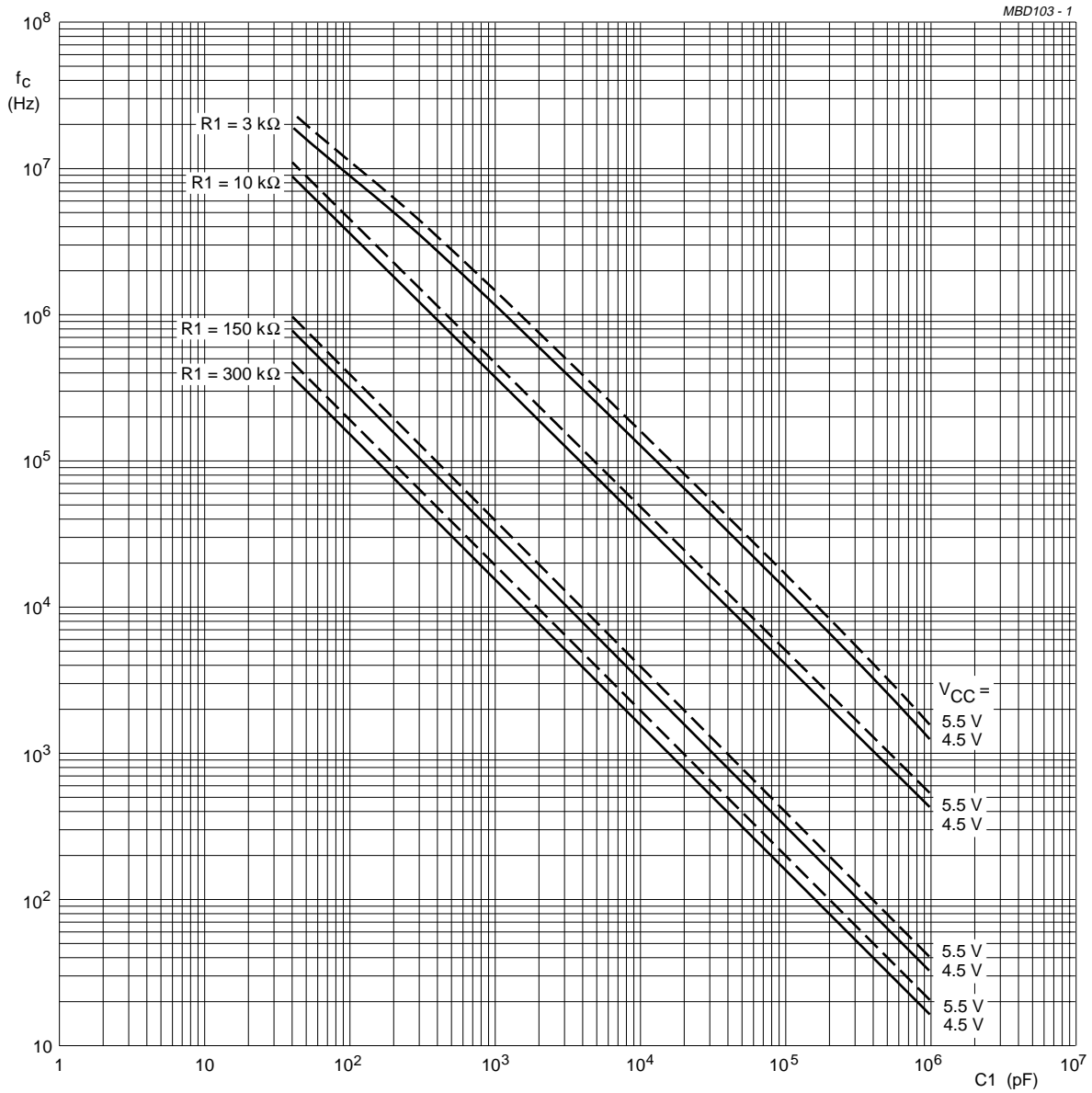

$R_2 = \infty$; $V_{VCOIN} = \frac{1}{2}V_{CC}$; $INH = GND$; $T_{amb} = 25\text{ }^\circ\text{C}$.

Fig.31 Typical value of VCO centre frequency (f_c) as a function of C_1 .

PLL with bandgap controlled VCO

74HCT9046A

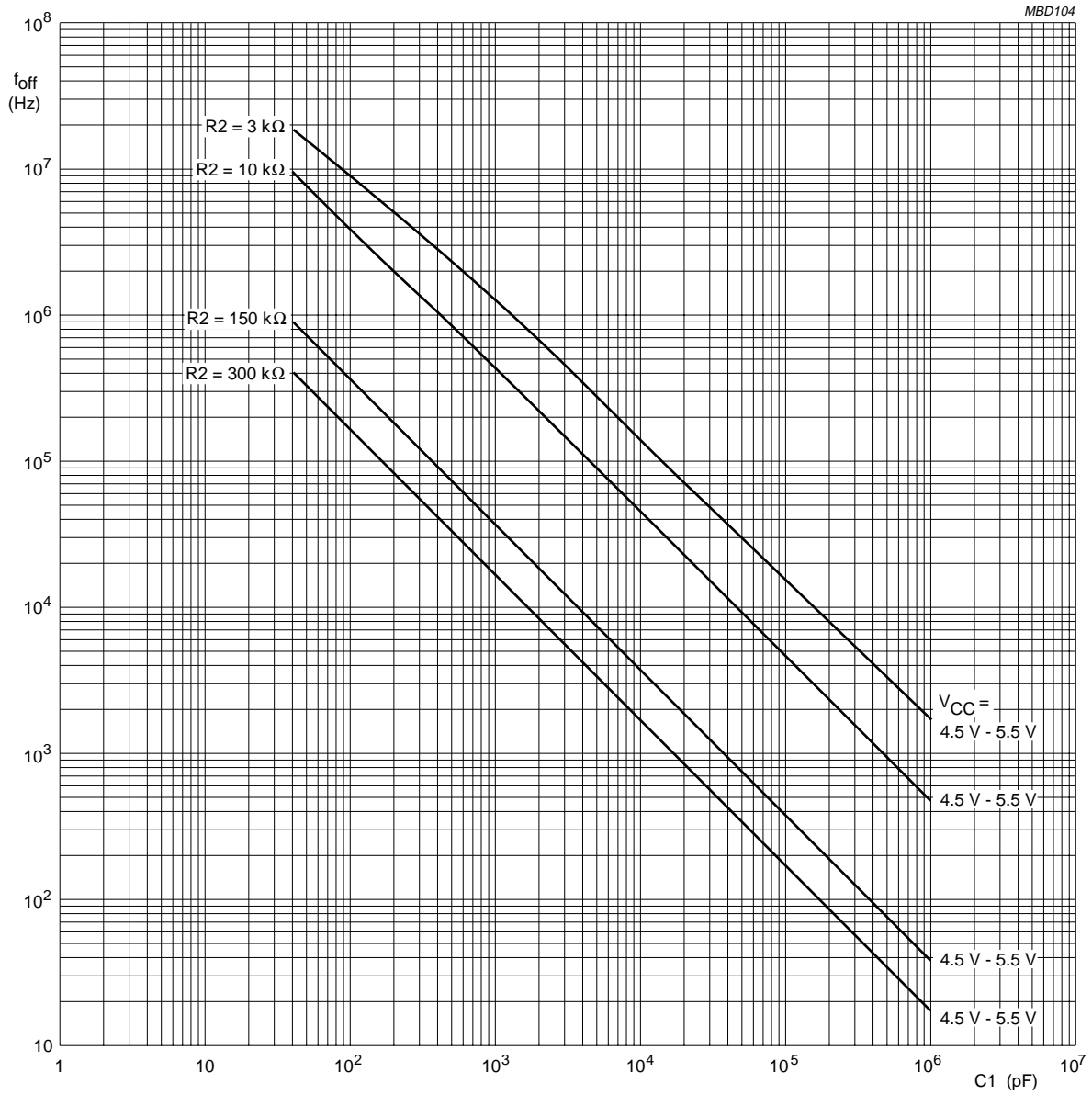

$R1 = \infty$; $V_{VCOIN} = \frac{1}{2}V_{CC}$; $INH = GND$; $T_{amb} = 25\text{ }^\circ\text{C}$.

Fig.32 Typical value of frequency offset as a function of $C1$.

PLL with bandgap controlled VCO

74HCT9046A

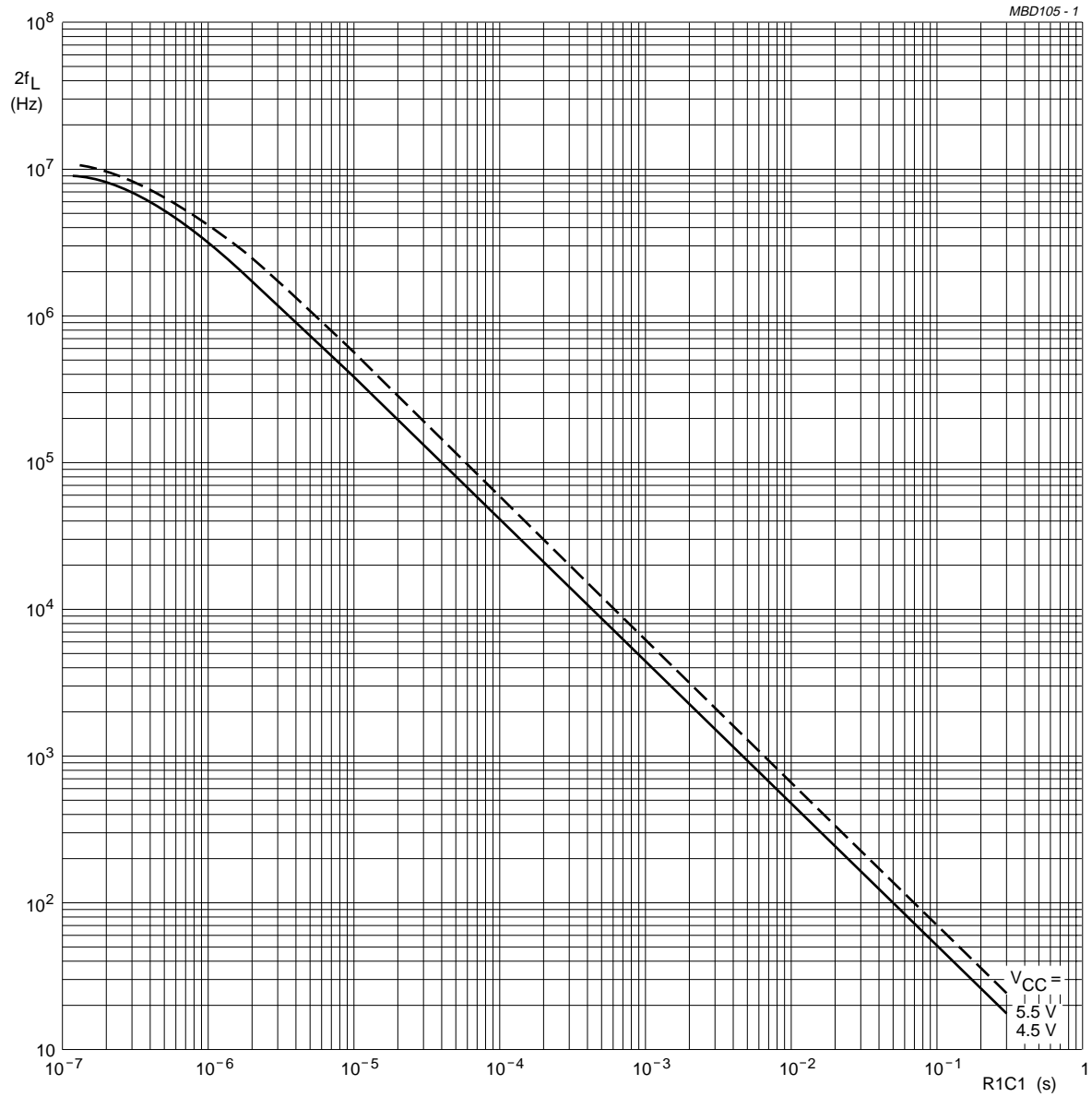

$$K_v = \frac{2f_L}{V_{VCOIN\ range}} 2\pi (r/s/V)$$

$V_{VCOIN} = 1.1 \text{ to } (V_{CC} - 1.1) \text{ V.}$

Fig.33 Typical frequency lock range $2f_L$ as a function of the product $R1$ and $C1$.

PLL with bandgap controlled VCO

74HCT9046A

PLL design example

The frequency synthesizer used in the design example shown in Fig.34 has the following parameters:

- Output frequency: 2 MHz to 3 MHz.
- Frequency steps: 100 kHz.
- Settling time: 1 ms.
- Overshoot: <20%.

The open loop gain is:

$$H(s) \times G(s) = K_p \times K_f \times K_o \times K_n$$

and the closed loop:

$$\frac{\Phi_u}{\Phi} = \frac{K_p \times K_f \times K_o \times K_n}{1 + K_p \times K_f \times K_o \times K_n}$$

- where: K_p = phase comparator gain
- K_f = low-pass filter transfer gain
- K_o = K_v/s VCO gain
- K_n = $1/n$ divider ratio.

The programmable counter ratio K_n can be found as follows:

$$N_{min} = \frac{f_{OUT}}{f_{step}} = \frac{2 \text{ MHz}}{100 \text{ kHz}} = 20$$

$$N_{max} = \frac{f_{OUT}}{f_{step}} = \frac{3 \text{ MHz}}{100 \text{ kHz}} = 30$$

The VCO is set by the values of R1, R2 and C1; R2 = 10 kΩ (adjustable).

The values can be determined using the information in Table 3.

With $f_c = 2.5 \text{ MHz}$ and $f_L = 500 \text{ kHz}$ this gives the following values ($V_{CC} = 5.0 \text{ V}$):

- R1 = 30 kΩ.
- R2 = 30 kΩ.
- C1 = 100 pF.

The VCO gain is:

$$K_v = \frac{2f_L \times 2\pi}{(V_{CC} - 1.1) - 1.1} =$$

$$\frac{1 \text{ MHz}}{2.8} \times 2\pi \approx 2.24 \times 10^6 \text{ r/s/V}$$

The gain of the phase comparator PC2 is:

$$K_p = \frac{5}{4 \times \pi} = 0.4 \text{ V/r}$$

Using PC2 with the passive filter as shown in Fig.34 results in a high gain loop with the same performance as a loop with an active filter. Hence loop filter equations as for a high gain loop should be used. The current source output of PC2 can be simulated then with a fictive filter resistance:

$$R3' = \frac{R_b}{17}$$

The transfer functions of the filter is given by:

$$K_f = \frac{1 + s\tau_2}{s\tau_2}$$

Where:

$$\tau_1 = R3' \times C2.$$

$$\tau_2 = R4 \times C2.$$

The characteristic equation is:

$$1 + K_p \times K_f \times K_o \times K_n$$

This results in:

$$1 + K_p \left(\frac{1 + s\tau_2}{s\tau_2} \right) \frac{K_v}{s} K_n = 0$$

or:

$$s^2 + sK_p K_v K_n \frac{\tau_2}{\tau_1} + K_p K_v K_n / \tau_1 = 0$$

This can be written as:

$$s^2 + 2\zeta\omega_n s + (\omega_n)^2 = 0$$

with the natural frequency ω_n defined

$$\text{as: } \omega_n = \sqrt{\frac{K_p \times K_v \times K_n}{\tau_1}} \text{ and the}$$

damping value given as:

$$\zeta = 0.5 \times \tau_2 \times \omega_n$$

In Fig.35 the output frequency response to a step of input frequency is shown.

The overshoot and settling time percentages are now used to determine ω_n . From Fig.35 it can be

seen that the damping ratio $\zeta = 0.707$ will produce an overshoot of less than 20% and settle to within 5% at $\omega_n t = 5$. The required settling time is 1 ms. This results in:

$$\omega_n = \frac{5}{t} = \frac{5}{0.001} = 5 \times 10^3 \text{ r/s}$$

Rewriting the equation for natural frequency results in:

$$\tau_1 = \frac{K_p \times K_v \times K_n}{(\omega_n)^2}$$

The maximum overshoot occurs at $N_{max} = 30$; hence $K_n = 1/30$:

$$\tau_1 = \frac{0.4 \times 2.24 \times 10^6}{5000^2 \times 30} = 0.0012$$

When C2 = 470 nF, it follows:

$$R3' = \frac{\tau_1}{C2} = \frac{0.0012}{470 \times 10^{-9}} = 2550$$

Hence the current source bias resistance $R_b = 17 \times 2550 = 43 \text{ k}\Omega$.

With $\zeta = 0.707$ ($0.5 \times \tau_2 \times \omega_n$) it follows:

$$\tau_2 = \frac{0.707}{0.5 \times 5000} = 0.00028$$

$$R4 = \frac{\tau_2}{C2} = \frac{0.00028}{470 \times 10^{-9}} = 600 \Omega$$

For extra ripple suppression a capacitor C3 can be connected in parallel with R4, with an extra $\tau_3 = R4 \times C3$.

For stability reasons τ_3 should be $< 0.1\tau_2$, hence $C3 < 0.1C2$, or $C3 = 39 \text{ nF}$.

PLL with bandgap controlled VCO

74HCT9046A

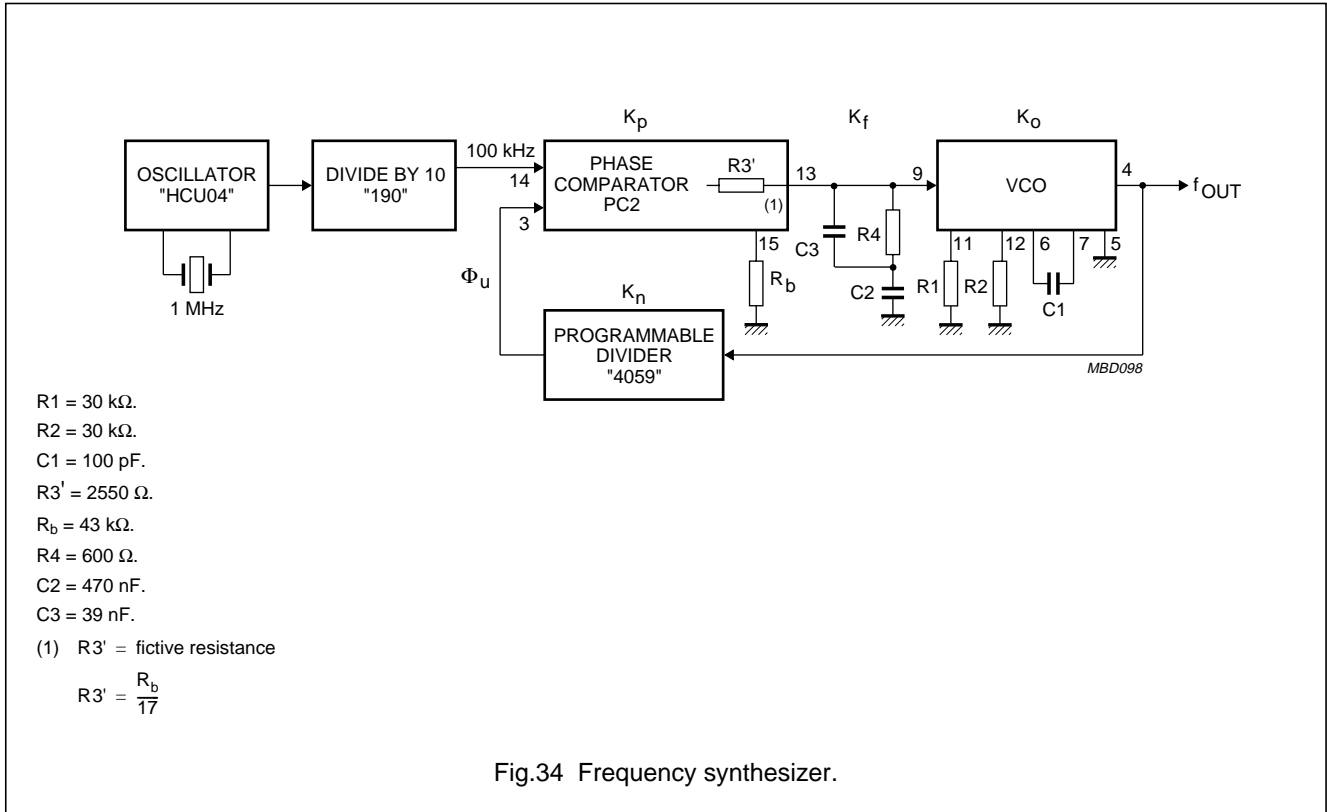

Fig.34 Frequency synthesizer.

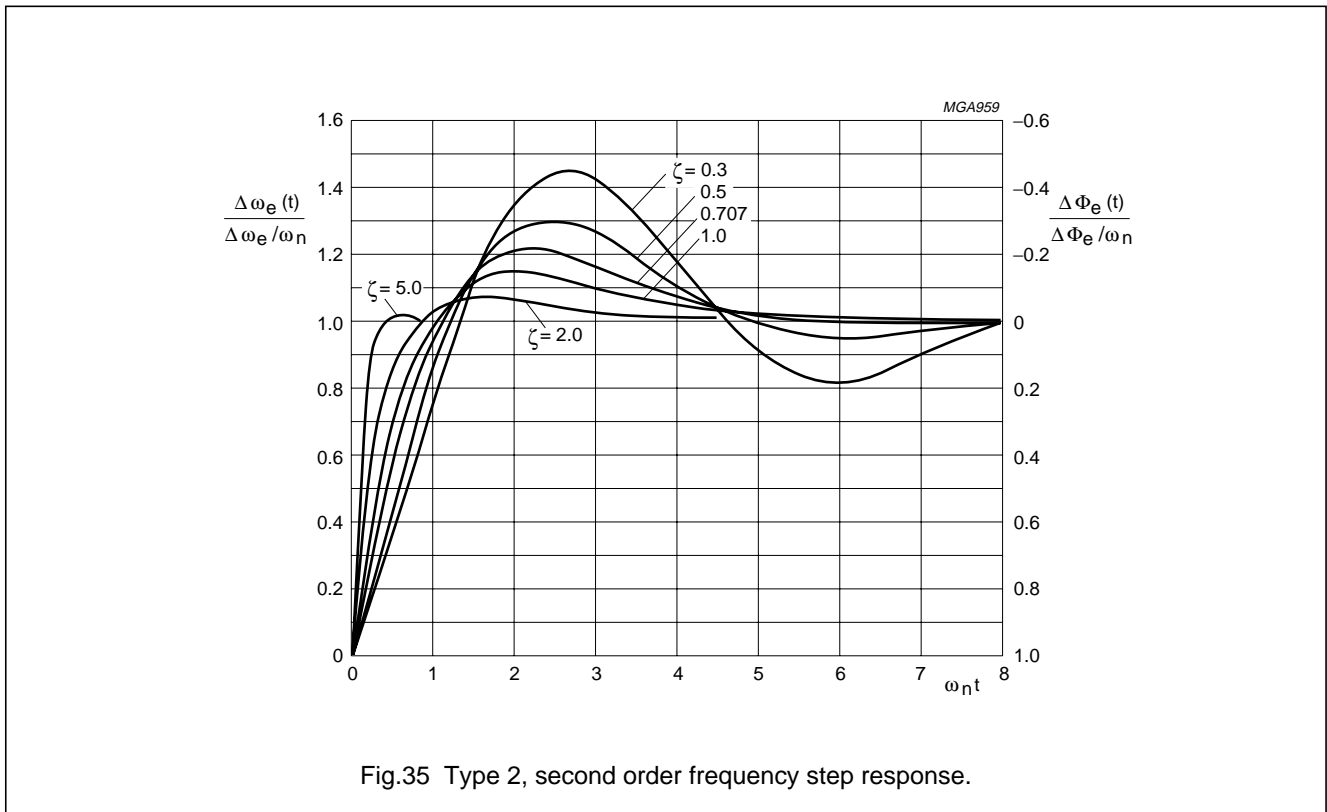

Fig.35 Type 2, second order frequency step response.

PLL with bandgap controlled VCO

74HCT9046A

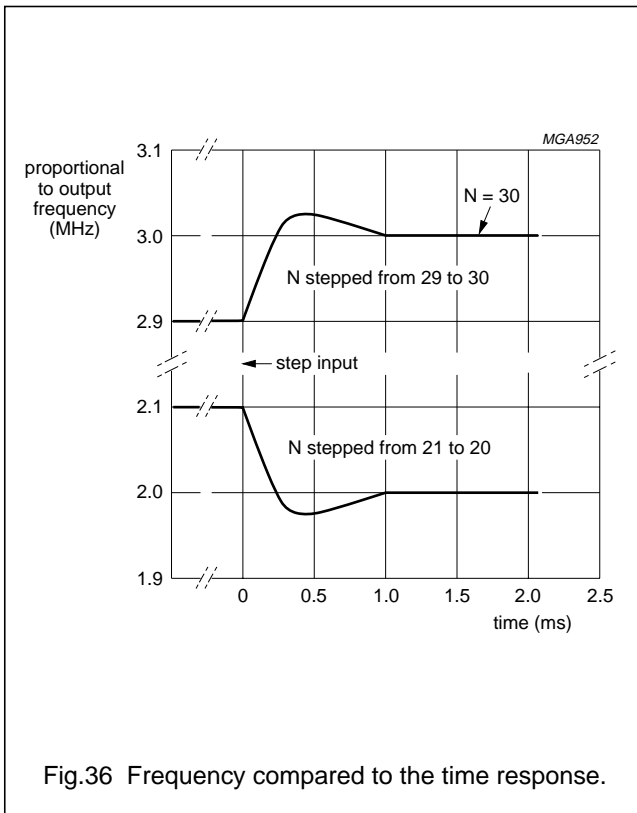

Fig.36 Frequency compared to the time response.

Since the output frequency is proportional to the VCO control voltage, the PLL frequency response can be observed with an oscilloscope by monitoring pin 9 of the VCO. The average frequency response, as calculated by the Laplace method, is found experimentally by smoothing this voltage at pin 9 with a simple RC filter, whose time constant is long compared with the phase detector sampling rate but short compared with the PLL response time.

Further information

For an extensive description and application example please refer to "Application note" ordering number 9398 649 90011. Also available a "Computer design program for PLLs" ordering number 9398 961 10061.

PLL with bandgap controlled VCO

74HCT9046A

PACKAGE OUTLINES

DIP16: plastic dual in-line package; 16 leads (300 mil); long body

SOT38-1

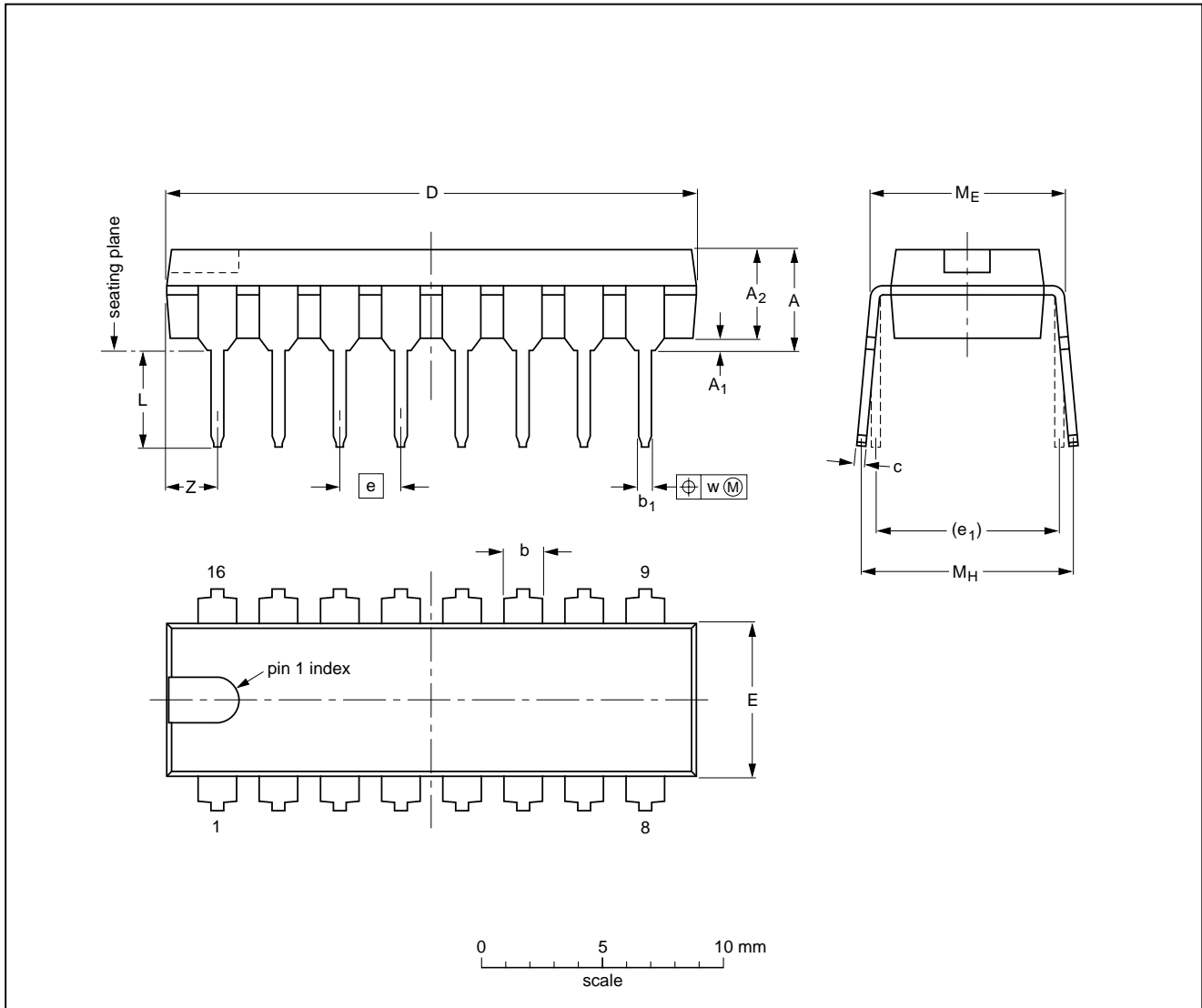

DIMENSIONS (inch dimensions are derived from the original mm dimensions)

UNIT	A max.	A ₁ min.	A ₂ max.	b	b ₁	c	D ⁽¹⁾	E ⁽¹⁾	e	e ₁	L	M _E	M _H	w	Z ⁽¹⁾ max.
mm	4.7	0.51	3.7	1.40 1.14	0.53 0.38	0.32 0.23	21.8 21.4	6.48 6.20	2.54	7.62	3.9 3.4	8.25 7.80	9.5 8.3	0.254	2.2
inches	0.19	0.020	0.15	0.055 0.045	0.021 0.015	0.013 0.009	0.86 0.84	0.26 0.24	0.10	0.30	0.15 0.13	0.32 0.31	0.37 0.33	0.01	0.087

Note

1. Plastic or metal protrusions of 0.25 mm maximum per side are not included.

OUTLINE VERSION	REFERENCES				EUROPEAN PROJECTION	ISSUE DATE
	IEC	JEDEC	EIAJ			
SOT38-1	050G09	MO-001AE				92-10-02 95-01-19

PLL with bandgap controlled VCO

74HCT9046A

SO16: plastic small outline package; 16 leads; body width 3.9 mm

SOT109-1

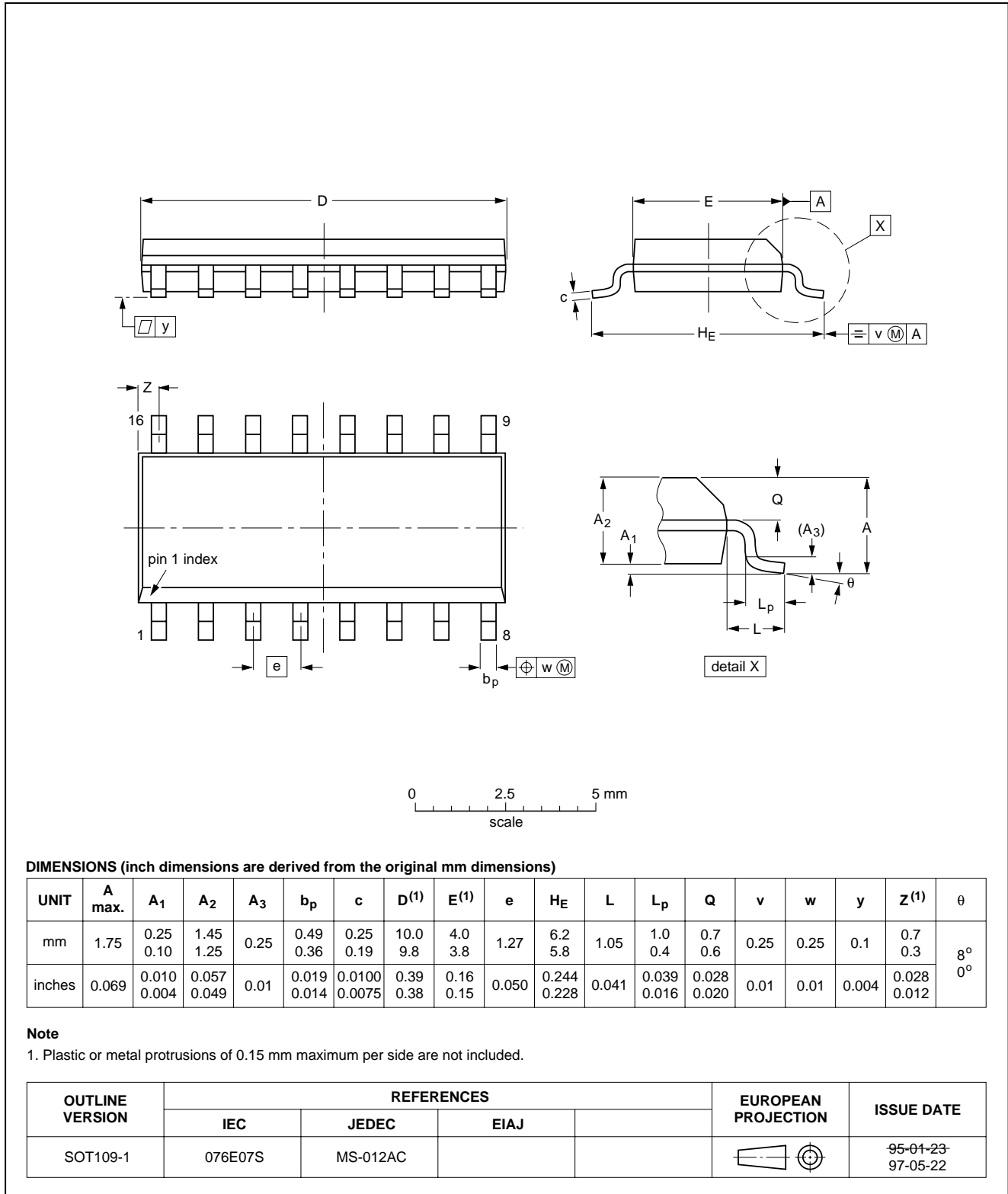

PLL with bandgap controlled VCO

74HCT9046A

SOLDERING

Introduction

This text gives a very brief insight to a complex technology. A more in-depth account of soldering ICs can be found in our *"Data Handbook IC26; Integrated Circuit Packages"* (document order number 9398 652 90011).

There is no soldering method that is ideal for all IC packages. Wave soldering is often preferred when through-hole and surface mount components are mixed on one printed-circuit board. However, wave soldering is not always suitable for surface mount ICs, or for printed-circuit boards with high population densities. In these situations reflow soldering is often used.

Through-hole mount packages

SOLDERING BY DIPPING OR BY SOLDER WAVE

The maximum permissible temperature of the solder is 260 °C; solder at this temperature must not be in contact with the joints for more than 5 seconds. The total contact time of successive solder waves must not exceed 5 seconds.

The device may be mounted up to the seating plane, but the temperature of the plastic body must not exceed the specified maximum storage temperature ($T_{stg(max)}$). If the printed-circuit board has been pre-heated, forced cooling may be necessary immediately after soldering to keep the temperature within the permissible limit.

MANUAL SOLDERING

Apply the soldering iron (24 V or less) to the lead(s) of the package, either below the seating plane or not more than 2 mm above it. If the temperature of the soldering iron bit is less than 300 °C it may remain in contact for up to 10 seconds. If the bit temperature is between 300 and 400 °C, contact may be up to 5 seconds.

Surface mount packages

REFLOW SOLDERING

Reflow soldering requires solder paste (a suspension of fine solder particles, flux and binding agent) to be applied to the printed-circuit board by screen printing, stencilling or pressure-syringe dispensing before package placement.

Several methods exist for reflowing; for example, infrared/convection heating in a conveyor type oven. Throughput times (preheating, soldering and cooling) vary between 100 and 200 seconds depending on heating method.

Typical reflow peak temperatures range from 215 to 250 °C. The top-surface temperature of the packages should preferably be kept below 230 °C.

WAVE SOLDERING

Conventional single wave soldering is not recommended for surface mount devices (SMDs) or printed-circuit boards with a high component density, as solder bridging and non-wetting can present major problems.

To overcome these problems the double-wave soldering method was specifically developed.

If wave soldering is used the following conditions must be observed for optimal results:

- Use a double-wave soldering method comprising a turbulent wave with high upward pressure followed by a smooth laminar wave.
- For packages with leads on two sides and a pitch (e):
 - larger than or equal to 1.27 mm, the footprint longitudinal axis is **preferred** to be parallel to the transport direction of the printed-circuit board;
 - smaller than 1.27 mm, the footprint longitudinal axis **must** be parallel to the transport direction of the printed-circuit board.

The footprint must incorporate solder thieves at the downstream end.

- For packages with leads on four sides, the footprint must be placed at a 45° angle to the transport direction of the printed-circuit board. The footprint must incorporate solder thieves downstream and at the side corners.

During placement and before soldering, the package must be fixed with a droplet of adhesive. The adhesive can be applied by screen printing, pin transfer or syringe dispensing. The package can be soldered after the adhesive is cured.

Typical dwell time is 4 seconds at 250 °C.

A mildly-activated flux will eliminate the need for removal of corrosive residues in most applications.

MANUAL SOLDERING

Fix the component by first soldering two diagonally-opposite end leads. Use a low voltage (24 V or less) soldering iron applied to the flat part of the lead. Contact time must be limited to 10 seconds at up to 300 °C.

When using a dedicated tool, all other leads can be soldered in one operation within 2 to 5 seconds between 270 and 320 °C.

PLL with bandgap controlled VCO

74HCT9046A

Suitability of IC packages for wave, reflow and dipping soldering methods

MOUNTING	PACKAGE	SOLDERING METHOD		
		WAVE	REFLOW ⁽¹⁾	DIPPING
Through-hole mount	DBS, DIP, HDIP, SDIP, SIL	suitable ⁽²⁾	–	suitable
Surface mount	BGA, SQFP	not suitable	suitable	–
	HLQFP, HSQFP, HSOP, HTSSOP, SMS	not suitable ⁽³⁾	suitable	–
	PLCC ⁽⁴⁾ , SO, SOJ	suitable	suitable	–
	LQFP, QFP, TQFP	not recommended ⁽⁴⁾⁽⁵⁾	suitable	–
	SSOP, TSSOP, VSO	not recommended ⁽⁶⁾	suitable	–

Notes

- All surface mount (SMD) packages are moisture sensitive. Depending upon the moisture content, the maximum temperature (with respect to time) and body size of the package, there is a risk that internal or external package cracks may occur due to vaporization of the moisture in them (the so called popcorn effect). For details, refer to the Drypack information in the "Data Handbook IC26; Integrated Circuit Packages; Section: Packing Methods".
- For SDIP packages, the longitudinal axis must be parallel to the transport direction of the printed-circuit board.
- These packages are not suitable for wave soldering as a solder joint between the printed-circuit board and heatsink (at bottom version) can not be achieved, and as solder may stick to the heatsink (on top version).
- If wave soldering is considered, then the package must be placed at a 45° angle to the solder wave direction. The package footprint must incorporate solder thieves downstream and at the side corners.
- Wave soldering is only suitable for LQFP, QFP and TQFP packages with a pitch (e) equal to or larger than 0.8 mm; it is definitely not suitable for packages with a pitch (e) equal to or smaller than 0.65 mm.
- Wave soldering is only suitable for SSOP and TSSOP packages with a pitch (e) equal to or larger than 0.65 mm; it is definitely not suitable for packages with a pitch (e) equal to or smaller than 0.5 mm.

DEFINITIONS

Data sheet status	
Objective specification	This data sheet contains target or goal specifications for product development.
Preliminary specification	This data sheet contains preliminary data; supplementary data may be published later.
Product specification	This data sheet contains final product specifications.
Limiting values	
Limiting values given are in accordance with the Absolute Maximum Rating System (IEC 134). Stress above one or more of the limiting values may cause permanent damage to the device. These are stress ratings only and operation of the device at these or at any other conditions above those given in the Characteristics sections of the specification is not implied. Exposure to limiting values for extended periods may affect device reliability.	
Application information	
Where application information is given, it is advisory and does not form part of the specification.	

LIFE SUPPORT APPLICATIONS

These products are not designed for use in life support appliances, devices, or systems where malfunction of these products can reasonably be expected to result in personal injury. Philips customers using or selling these products for use in such applications do so at their own risk and agree to fully indemnify Philips for any damages resulting from such improper use or sale.

Philips Semiconductors – a worldwide company

Argentina: see South America

Australia: 34 Waterloo Road, NORTH RYDE, NSW 2113,
Tel. +61 2 9805 4455, Fax. +61 2 9805 4466

Austria: Computerstr. 6, A-1101 WIEN, P.O. Box 213,
Tel. +43 1 60 101 1248, Fax. +43 1 60 101 1210

Belarus: Hotel Minsk Business Center, Bld. 3, r. 1211, Volodarski Str. 6,
220050 MINSK, Tel. +375 172 20 0733, Fax. +375 172 20 0773

Belgium: see The Netherlands

Brazil: see South America

Bulgaria: Philips Bulgaria Ltd., Energoproject, 15th floor,
51 James Bourchier Blvd., 1407 SOFIA,
Tel. +359 2 68 9211, Fax. +359 2 68 9102

Canada: PHILIPS SEMICONDUCTORS/COMPONENTS,
Tel. +1 800 234 7381, Fax. +1 800 943 0087

China/Hong Kong: 501 Hong Kong Industrial Technology Centre,
72 Tat Chee Avenue, Kowloon Tong, HONG KONG,
Tel. +852 2319 7888, Fax. +852 2319 7700

Colombia: see South America

Czech Republic: see Austria

Denmark: Sydhavnsgade 23, 1780 COPENHAGEN V,
Tel. +45 33 29 3333, Fax. +45 33 29 3905

Finland: Sinikalliontie 3, FIN-02630 ESPOO,
Tel. +358 9 615 800, Fax. +358 9 6158 0920

France: 51 Rue Carnot, BP317, 92156 SURESNES Cedex,
Tel. +33 1 4099 6161, Fax. +33 1 4099 6427

Germany: Hammerbrookstraße 69, D-20097 HAMBURG,
Tel. +49 40 2353 60, Fax. +49 40 2353 6300

Greece: No. 15, 25th March Street, GR 17778 TAVROS/ATHENS,
Tel. +30 1 489 4339/4239, Fax. +30 1 481 4240

Hungary: see Austria

India: Philips INDIA Ltd, Band Box Building, 2nd floor,
254-D, Dr. Annie Besant Road, Worli, MUMBAI 400 025,
Tel. +91 22 493 8541, Fax. +91 22 493 0966

Indonesia: PT Philips Development Corporation, Semiconductors Division,
Gedung Philips, Jl. Buncit Raya Kav.99-100, JAKARTA 12510,
Tel. +62 21 794 0040 ext. 2501, Fax. +62 21 794 0080

Ireland: Newstead, Clonskeagh, DUBLIN 14,
Tel. +353 1 7640 000, Fax. +353 1 7640 200

Israel: RAPAC Electronics, 7 Kehilat Saloniki St, PO Box 18053,
TEL AVIV 61180, Tel. +972 3 645 0444, Fax. +972 3 649 1007

Italy: PHILIPS SEMICONDUCTORS, Piazza IV Novembre 3,
20124 MILANO, Tel. +39 2 6752 2531, Fax. +39 2 6752 2557

Japan: Philips Bldg 13-37, Kohnan 2-chome, Minato-ku,
TOKYO 108-8507, Tel. +81 3 3740 5130, Fax. +81 3 3740 5077

Korea: Philips House, 260-199 Itaewon-dong, Yongsan-ku, SEOUL,
Tel. +82 2 709 1412, Fax. +82 2 709 1415

Malaysia: No. 76 Jalan Universiti, 46200 PETALING JAYA, SELANGOR,
Tel. +60 3 750 5214, Fax. +60 3 757 4880

Mexico: 5900 Gateway East, Suite 200, EL PASO, TEXAS 79905,
Tel. +9-5 800 234 7381, Fax +9-5 800 943 0087

Middle East: see Italy

Netherlands: Postbus 90050, 5600 PB EINDHOVEN, Bldg. VB,
Tel. +31 40 27 82785, Fax. +31 40 27 88399

New Zealand: 2 Wagener Place, C.P.O. Box 1041, AUCKLAND,
Tel. +64 9 849 4160, Fax. +64 9 849 7811

Norway: Box 1, Manglerud 0612, OSLO,
Tel. +47 22 74 8000, Fax. +47 22 74 8341

Pakistan: see Singapore

Philippines: Philips Semiconductors Philippines Inc.,
106 Valero St. Salcedo Village, P.O. Box 2108 MCC, MAKATI,
Metro MANILA, Tel. +63 2 816 6380, Fax. +63 2 817 3474

Poland: Ul. Lukiska 10, PL 04-123 WARSZAWA,
Tel. +48 22 612 2831, Fax. +48 22 612 2327

Portugal: see Spain

Romania: see Italy

Russia: Philips Russia, Ul. Usatcheva 35A, 119048 MOSCOW,
Tel. +7 095 755 6918, Fax. +7 095 755 6919

Singapore: Lorong 1, Toa Payoh, SINGAPORE 319762,
Tel. +65 350 2538, Fax. +65 251 6500

Slovakia: see Austria

Slovenia: see Italy

South Africa: S.A. PHILIPS Pty Ltd., 195-215 Main Road Martindale,
2092 JOHANNESBURG, P.O. Box 7430 Johannesburg 2000,
Tel. +27 11 470 5911, Fax. +27 11 470 5494

South America: Al. Vicente Pinzon, 173, 6th floor,
04547-130 SÃO PAULO, SP, Brazil,
Tel. +55 11 821 2333, Fax. +55 11 821 2382

Spain: Balmes 22, 08007 BARCELONA,
Tel. +34 93 301 6312, Fax. +34 93 301 4107

Sweden: Kottbygatan 7, Akalla, S-16485 STOCKHOLM,
Tel. +46 8 5985 2000, Fax. +46 8 5985 2745

Switzerland: Allmendstrasse 140, CH-8027 ZÜRICH,
Tel. +41 1 488 2741 Fax. +41 1 488 3263

Taiwan: Philips Semiconductors, 6F, No. 96, Chien Kuo N. Rd., Sec. 1,
TAIPEI, Taiwan Tel. +886 2 2134 2865, Fax. +886 2 2134 2874

Thailand: PHILIPS ELECTRONICS (THAILAND) Ltd.,
209/2 Sanpavuth-Bangna Road Prakanong, BANGKOK 10260,
Tel. +66 2 745 4090, Fax. +66 2 398 0793

Turkey: Talatpasa Cad. No. 5, 80640 GÜLTEPE/ISTANBUL,
Tel. +90 212 279 2770, Fax. +90 212 282 6707

Ukraine: PHILIPS UKRAINE, 4 Patrice Lumumba str., Building B, Floor 7,
252042 KIEV, Tel. +380 44 264 2776, Fax. +380 44 268 0461

United Kingdom: Philips Semiconductors Ltd., 276 Bath Road, Hayes,
MIDDLESEX UB3 5BX, Tel. +44 181 730 5000, Fax. +44 181 754 8421

United States: 811 East Arques Avenue, SUNNYVALE, CA 94088-3409,
Tel. +1 800 234 7381, Fax. +1 800 943 0087

Uruguay: see South America

Vietnam: see Singapore

Yugoslavia: PHILIPS, Trg N. Pasica 5/v, 11000 BEOGRAD,
Tel. +381 11 62 5344, Fax. +381 11 63 5777

For all other countries apply to: Philips Semiconductors,
International Marketing & Sales Communications, Building BE-p, P.O. Box 218,
5600 MD EINDHOVEN, The Netherlands, Fax. +31 40 27 24825

Internet: <http://www.semiconductors.philips.com>

© Philips Electronics N.V. 1999

SCA61

All rights are reserved. Reproduction in whole or in part is prohibited without the prior written consent of the copyright owner.

The information presented in this document does not form part of any quotation or contract, is believed to be accurate and reliable and may be changed without notice. No liability will be accepted by the publisher for any consequence of its use. Publication thereof does not convey nor imply any license under patent- or other industrial or intellectual property rights.

Printed in The Netherlands

245002/00/03/pp40

Date of release: 1999 Jan 11

Document order number: 9397 750 05007

Let's make things better.

**Philips
Semiconductors**



PHILIPS