

# DATA SHEET



**PCF8548**

**65 × 102 pixels matrix LCD driver**

Product specification  
Supersedes data of 1999 Mar 22  
File under Integrated Circuits, IC12

1999 Aug 16

**65 × 102 pixels matrix LCD driver****PCF8548**

<b>CONTENTS</b>			
1	FEATURES	12	INSTRUCTIONS
2	APPLICATIONS	12.1	External reset ( $\overline{\text{RES}}$ )
3	GENERAL DESCRIPTION	12.2	Function set
3.1	Packages	12.2.1	Power-Down (PD)
4	ORDERING INFORMATION	12.2.2	V
5	BLOCK DIAGRAM	12.2.3	H
6	PINNING	12.2.4	MX
7	PIN FUNCTIONS	12.2.5	MY
7.1	R0 to R64: row driver outputs	12.3	Display control
7.2	C0 to C101: column driver outputs	12.3.1	D and E
7.3	V <sub>SS1</sub> and V <sub>SS2</sub> : negative power supply rails	12.4	Display configuration
7.4	V <sub>DD1</sub> to V <sub>DD3</sub> : positive power supply rails	12.4.1	TRS
7.5	V <sub>LCDIN</sub> : LCD power supply	12.4.2	BRS
7.6	V <sub>LCDOUT</sub> : LCD power supply	12.5	Set Y address of RAM
7.7	V <sub>LCDSENSE</sub> : voltage multiplier regulation input (V <sub>LCD</sub> )	12.6	Set X address of RAM
7.8	T1 to T12: test pads	12.7	Set HV generator stages
7.9	SDAIN and SDAOUT: I <sup>2</sup> C-bus data lines	12.7.1	S[1:0]
7.10	SCL: I <sup>2</sup> C-bus clock signal	12.8	Temperature control
7.11	SA0: slave address	12.9	Bias system
7.12	OSC: oscillator	12.10	Set V <sub>OP</sub> value
7.13	RES: reset	13	LIMITING VALUES
8	BLOCK DIAGRAM FUNCTIONS	14	HANDLING
8.1	Oscillator	15	DC CHARACTERISTICS
8.2	I <sup>2</sup> C-bus interface	16	AC CHARACTERISTICS
8.3	Display control logic	17	RESET
8.4	Display Data RAM (DDRAM)	18	APPLICATION INFORMATION
8.5	Timing generator	19	CHIP INFORMATION
8.6	LCD row and column drivers	20	PAD INFORMATION
9	INITIALIZATION	21	DEVICE PROTECTION DIAGRAM
10	ADDRESSING	22	TRAY INFORMATION
10.1	Display data RAM structure	23	DEFINITIONS
10.2	RAM access	24	LIFE SUPPORT APPLICATIONS
11	I <sup>2</sup> C-BUS INTERFACE	25	PURCHASE OF PHILIPS I <sup>2</sup> C COMPONENTS
11.1	Characteristics of the I <sup>2</sup> C-bus	26	BARE DIE DISCLAIMER
11.1.1	Bit transfer		
11.1.2	START and STOP conditions		
11.1.3	System configuration		
11.1.4	Acknowledge		
11.2	I <sup>2</sup> C-bus protocol		

## 65 × 102 pixels matrix LCD driver

PCF8548

**1 FEATURES**

- Single-chip LCD controller/driver
- 65 row and 102 column outputs
- Display data RAM 65 × 102 bits
- On-chip:
  - Configurable 5 (4, 3 and 2) × voltage multiplier generating  $V_{LCD}$  (external  $V_{LCD}$  also possible)
  - Generation of intermediate LCD bias voltages
  - Oscillator requires no external components (external clock also possible).
- 400 kbits/s fast I<sup>2</sup>C-bus interface
- CMOS compatible inputs
- Mux rate: 1 : 65
- Logic supply voltage range  $V_{DD1}$  to  $V_{SS}$ :
  - 1.9 to 5.5 V.
- High voltage generator supply voltage range  $V_{DD2}$  to  $V_{SS}$  and  $V_{DD3}$  to  $V_{SS}$ :
  - 2.4 to 4.5 V with LCD voltage internally generated (voltage generator enabled).
- Display supply voltage range  $V_{LCD}$  to  $V_{SS}$ :
  - 4.5 to 9.0 V
- Low power consumption, suitable for battery operated systems
- Temperature compensation of  $V_{LCD}$
- Slim chip layout, suitable for Chip-On-Glass (COG) applications
- Programmable bottom row pads mirroring and top row pads mirroring, for compatibility with both Tape Carrier Package (TCP) and COG applications.

**2 APPLICATIONS**

- Telecom equipment
- Portable instruments
- Point of sale terminals.

**3 GENERAL DESCRIPTION**

The PCF8548 is a low power CMOS LCD controller driver, designed to drive a graphic display of 65 rows and 102 columns. All necessary functions for the display are provided in a single chip, including on-chip generation of LCD supply and bias voltages, resulting in a minimum of external components and low power consumption. The PCF8548 interfaces to most microcontrollers via an I<sup>2</sup>C-bus interface.

**3.1 Packages**

The PCF8548 is available as chip with bumps in tray; tape carrier package is available on request.

**4 ORDERING INFORMATION**

TYPE NUMBER	PACKAGE		
	NAME	DESCRIPTION	VERSION
PCF8548U/2	Tray	chip with bumps in tray	–
PCF8548U/9	Bumped wafer	quarter wafer	–

65 × 102 pixels matrix LCD driver

PCF8548

5 BLOCK DIAGRAM

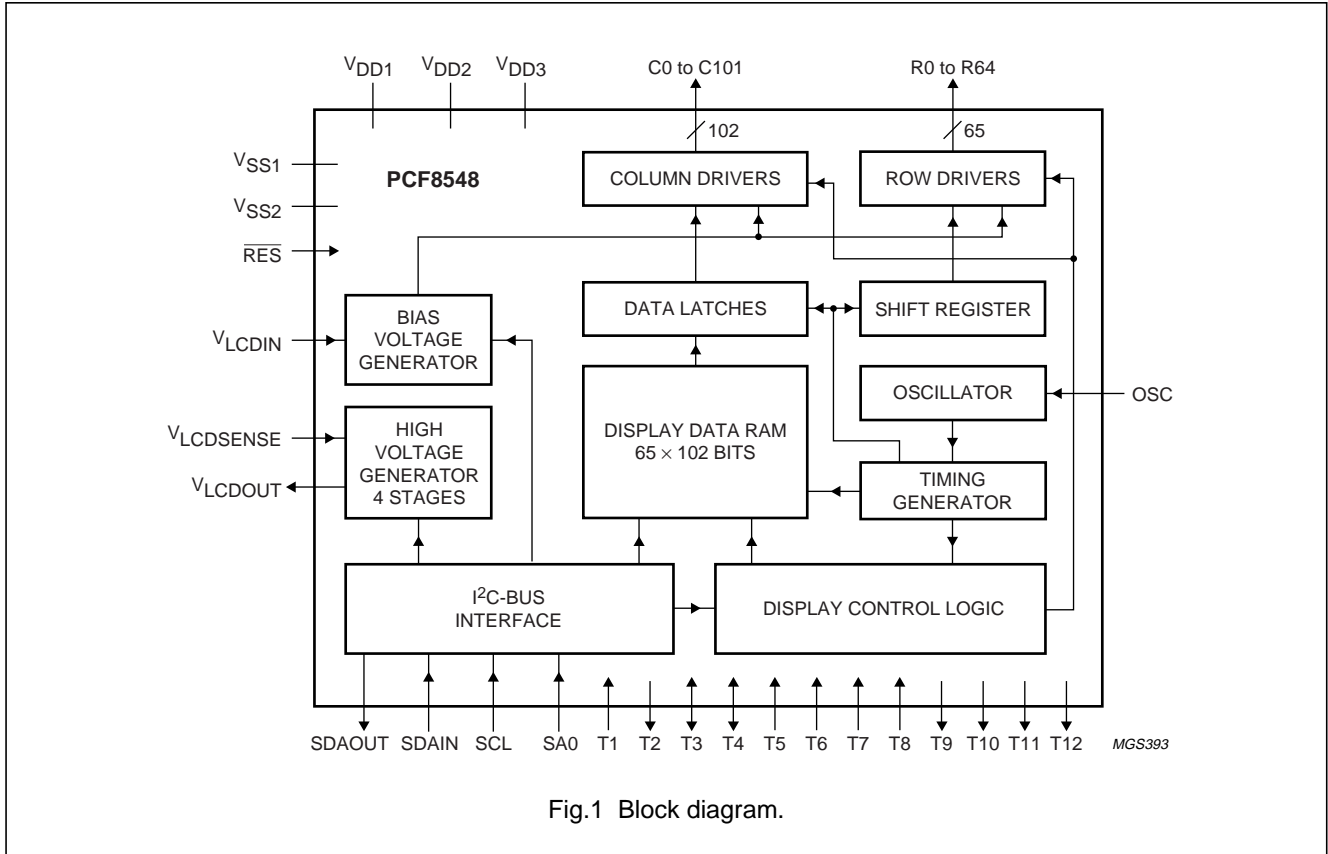

6 PINNING

SYMBOL	PAD	DESCRIPTION
RES	1	external reset input (active LOW)
SDAOUT	2	I <sup>2</sup> C-bus data output
SDAIN	3 and 4	I <sup>2</sup> C-bus data input
SCL	5 and 6	I <sup>2</sup> C-bus clock input
T2	7	test 2 output
SA0	8	least significant bit of slave address
T7 to T5	9 to 11	test inputs
T4 and T3	12 and 13	test input/output
T1	14	test input
V <sub>SS1</sub>	15 to 20	negative power supply 1
V <sub>SS2</sub>	21 to 26	negative power supply 2
V <sub>LCDOUT</sub>	28 to 33	voltage multiplier output
V <sub>LCDSENSE</sub>	34	voltage multiplier regulation input (V <sub>LCD</sub> )

SYMBOL	PAD	DESCRIPTION
V <sub>LCDIN</sub>	35 to 40	LCD supply voltage
R32 to R19	41 to 54	LCD row driver outputs
R0 to R18	57 to 75	LCD row driver outputs
C0 to C101	76 to 177	LCD column driver outputs
R50 to R33	178 to 195	LCD row driver outputs
R51 to R64	198 to 211	LCD row driver outputs
T12 to T9	212 to 215	test outputs
OSC	216	oscillator
T8	217	test input
V <sub>DD1</sub>	218 to 223	supply voltage 1
V <sub>DD3</sub>	224 to 226	supply voltage 3
V <sub>DD2</sub>	227 to 233	supply voltage 2
	27, 55, 56, 196 and 197	dummy pads

## 65 × 102 pixels matrix LCD driver

## PCF8548

**7 PIN FUNCTIONS****7.1 R0 to R64: row driver outputs**

These pads output the row signals.

**7.2 C0 to C101: column driver outputs**

These pads output the column signals.

**7.3 V<sub>SS1</sub> and V<sub>SS2</sub>: negative power supply rails**

V<sub>SS2</sub> is related to V<sub>DD2</sub> and V<sub>DD3</sub> and V<sub>SS1</sub> is related to V<sub>DD1</sub>.

**7.4 V<sub>DD1</sub> to V<sub>DD3</sub>: positive power supply rails**

V<sub>DD2</sub> and V<sub>DD3</sub> are the supply voltages for the internal voltage generator. Both have to be at the same voltage and must be connected together outside of the chip. If the internal voltage generator is not used, they should both be connected to power or to the V<sub>DD1</sub> pad.

V<sub>DD1</sub> is used as the power supply for the rest of the chip. This voltage can be a different voltage than V<sub>DD2</sub> and V<sub>DD3</sub>.

**7.5 V<sub>LCDIN</sub>: LCD power supply**

Internally generated positive power supply for the liquid crystal display. An external LCD supply voltage can be supplied using the V<sub>LCDIN</sub> pad. In this case, V<sub>LCDOUT</sub> has to be connected to ground, and the internal voltage generator has to be programmed to zero. If the PCF8548 is in power-down mode, the external LCD supply voltage must be switched off.

**7.6 V<sub>LCDOUT</sub>: LCD power supply**

Positive power supply for the liquid crystal display. If the internal voltage generator is used, the two supply rails V<sub>LCDIN</sub> and V<sub>LCDOUT</sub> must be connected together and an external capacitor must be connected (see Fig.19).

**7.7 V<sub>LCDSENSE</sub>: voltage multiplier regulation input (V<sub>LCD</sub>)**

V<sub>LCDSENSE</sub> is the input voltage for the internal voltage multiplier regulation.

If the internal voltage generator is used then V<sub>LCDSENSE</sub> must be connected to V<sub>LCDOUT</sub>. If an external supply voltage is used then V<sub>LCDSENSE</sub> must be connected to ground.

**7.8 T1 to T12: test pads**

T1 and T3 to T7 must be connected to V<sub>SS1</sub>. T8 must be connected to V<sub>DD1</sub>. T2 and T9 to T12 must be left open-circuit; not accessible to user.

**7.9 SDAIN and SDAOUT: I<sup>2</sup>C-bus data lines**

Serial data and acknowledge lines for the I<sup>2</sup>C-bus. By connecting SDAIN to SDAOUT, the SDA line becomes fully I<sup>2</sup>C-bus compatible. Having the acknowledge output (SDAOUT) separated from the serial data line is advantageous in Chip-On-Glass (COG) applications. In COG applications where the track resistance from the SDAOUT pad to the system SDA line can be significant, a potential divider is generated by the bus pull-up resistor and the Indium Tin Oxide (ITO) track resistance. It is possible that during the acknowledge cycle the PCF8548 will not be able to create a valid logic 0 level. By splitting the SDA input from the output the device could be used in a mode that ignores the acknowledge bit. In COG applications where the acknowledge cycle is required, it is necessary to minimize the track resistance from the SDACK pad to the system SDA line to guarantee a valid LOW level.

**7.10 SCL: I<sup>2</sup>C-bus clock signal**

I<sup>2</sup>C-bus serial clock signal input.

**7.11 SA0: slave address**

Two different slave addresses can be selected using the SA0 pad. This allows two PCF8548 LCD drivers to be connected to the same I<sup>2</sup>C-bus.

**7.12 OSC: oscillator**

When the on-chip oscillator is used this input must be connected to V<sub>DD1</sub>. An external clock signal, if used, is connected to this input.

**7.13  $\overline{\text{RES}}$ : reset**

This signal is used to reset the device. The signal is active LOW.

---

**65 × 102 pixels matrix LCD driver****PCF8548**

---

**8 BLOCK DIAGRAM FUNCTIONS****8.1 Oscillator**

The on-chip oscillator provides the clock signal for the display system. No external components are required and the OSC input must be connected to  $V_{DD1}$ . An external clock signal (if used), is connected to this input.

**8.2 I<sup>2</sup>C-bus interface**

The I<sup>2</sup>C-bus interface receives and executes the commands sent via the I<sup>2</sup>C-bus. It also receives RAM data and sends it to the RAM.

**8.3 Display control logic**

The display control logic generates the control signals to read from the RAM via the 102 bits parallel port. It also generates the control signals for the row and column drivers.

**8.4 Display Data RAM (DDRAM)**

The PCF8548 contains a 65 × 102 bit static RAM which stores the display data. The RAM is divided into 8 banks of 102 bytes and 1 bank of 102 bits [(8 × 8 + 1) × 102 bits]. During RAM access, data is transferred to the RAM via the I<sup>2</sup>C-bus interface. There is a direct correspondence between the X address and column output number.

**8.5 Timing generator**

The timing generator produces the various signals required to drive the internal circuitry. Internal chip operation is not disturbed by operations on the I<sup>2</sup>C-bus.

**8.6 LCD row and column drivers**

The PCF8548 contains 65 row and 102 column drivers, which connect the appropriate LCD bias voltages to the display in accordance with the data to be displayed. Figure 2 shows typical waveforms. Unused outputs should be left unconnected.

**9 INITIALIZATION**

Immediately following Power-on, all internal registers and the RAM content are undefined. A reset pulse must first be applied.

Reset is accomplished by applying an external  $\overline{RES}$  pulse (active LOW). When reset occurs within the specified time all internal registers are initialized, however the RAM is still undefined. The state after reset is described in Section 12.1.

The  $\overline{RES}$  input must be  $\leq 0.3 V_{DD}$  when  $V_{DD}$  reaches  $V_{DD(min)}$  (or higher) within a maximum time  $t_{VHRL}$  after  $V_{DD}$  goes HIGH (see Fig.17).

65 × 102 pixels matrix LCD driver

PCF8548

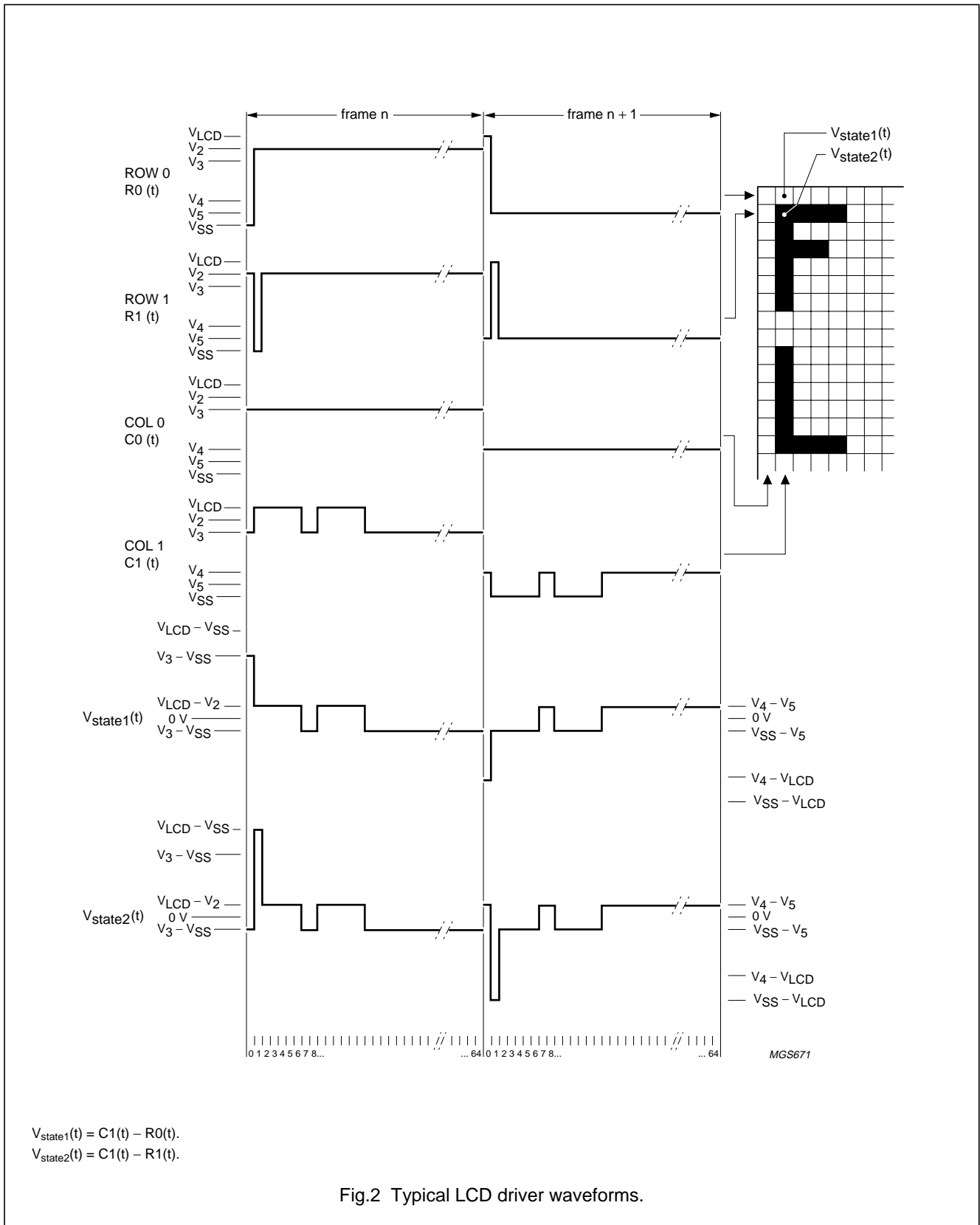

Fig.2 Typical LCD driver waveforms.

65 × 102 pixels matrix LCD driver

PCF8548

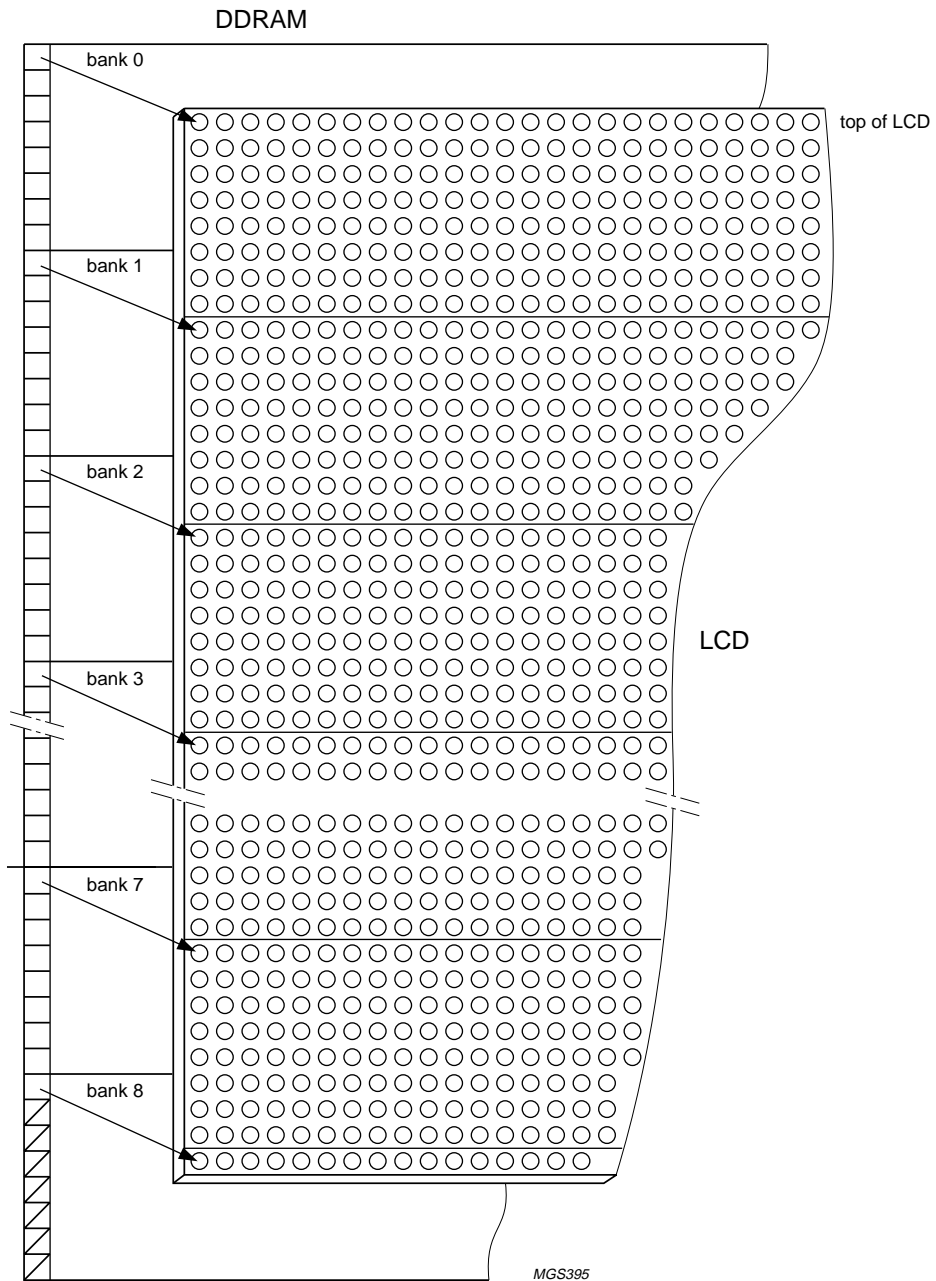

Fig.3 DDRAM to display mapping.



# 65 × 102 pixels matrix LCD driver

# PCF8548

## 10 ADDRESSING

The Display Data RAM (DDRAM) of the PCF8548 is accessed as indicated in Figs 3, 6, 7, 8 and 9. The DDRAM has a matrix of 65 × 102 bits. The RAM cells are addressed by the X and Y address pointers. The address ranges are X0 to X101 (1100101b) and Y0 to Y8 (1000b). Addresses outside of these ranges are not allowed. In vertical addressing mode (V = 1) the Y address increments after each byte (see Fig.5). After the last Y address (Y = 8), Y wraps around to 0 and X increments to address the next column. In the horizontal addressing mode (V = 0) the X address increments after each byte (see Fig.4). After the last X address (X = 101), X wraps around to 0 and Y increments to address the next row. After the very last address (X = 101 and Y = 8) the address pointers wrap around to address X = 0 and Y = 0.

### 10.1 Display data RAM structure

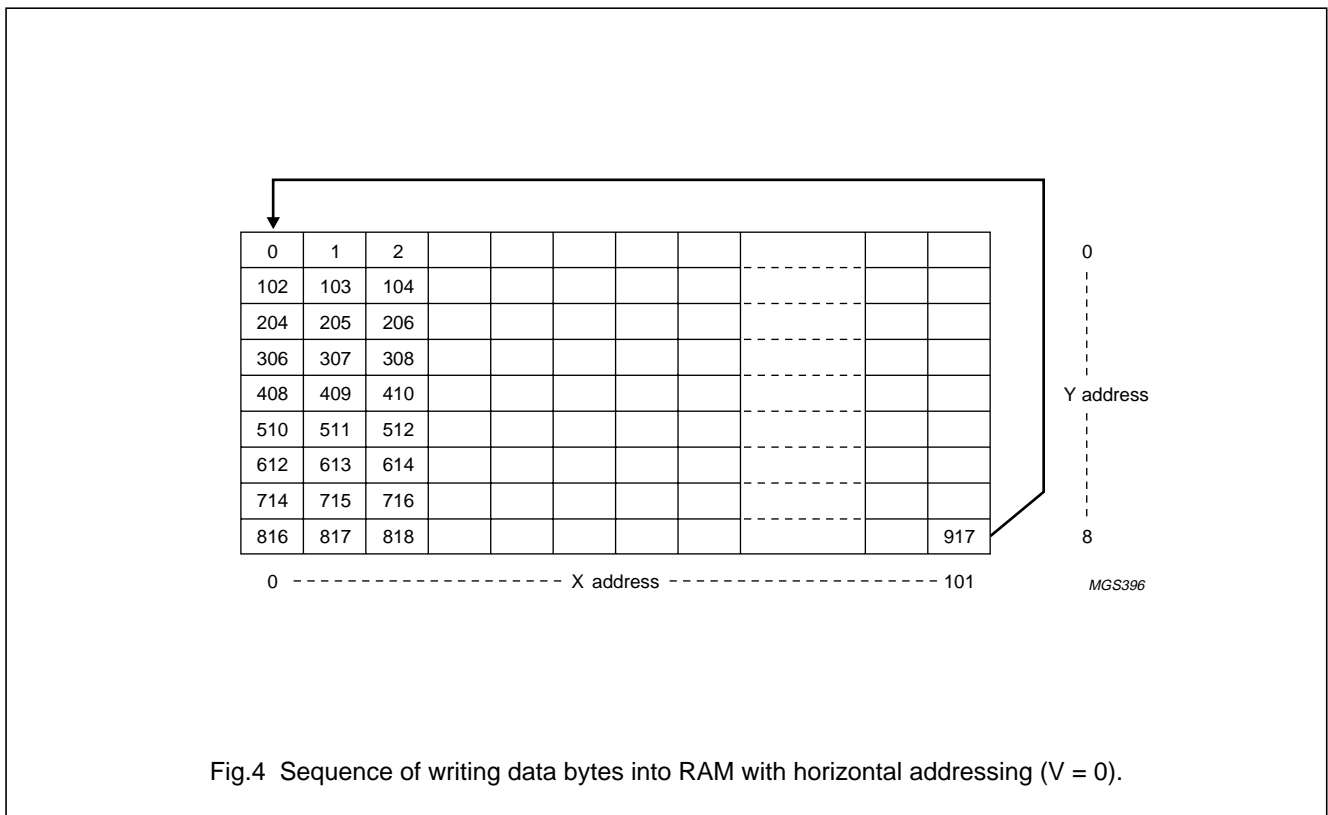

65 × 102 pixels matrix LCD driver

PCF8548

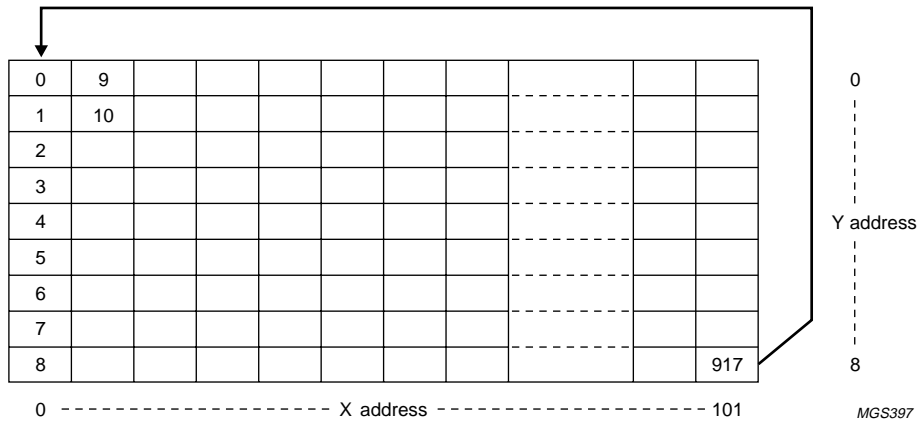

Fig.5 Sequence of writing data bytes into RAM with vertical addressing (V = 1).

The DO bit defines the bit order (MSB on top or MSB on bottom) for writing to the RAM (see Figs 6 and 7).

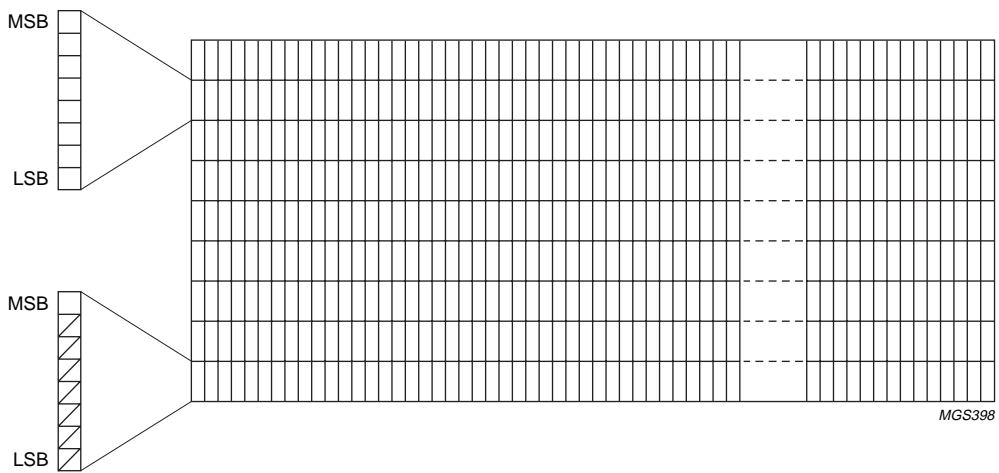
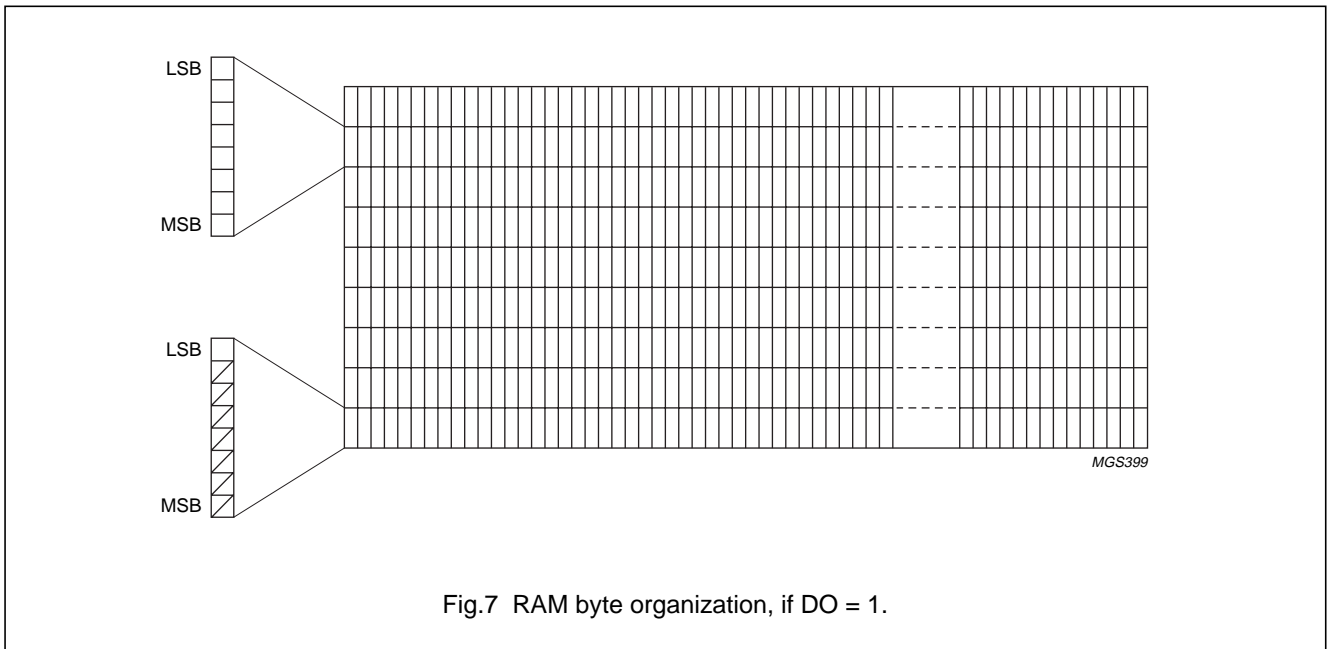

Fig.6 RAM byte organization, if DO = 0.

65 × 102 pixels matrix LCD driver

PCF8548



The MX bit allows a horizontal mirroring; when MX = 1, the X address space is mirrored. The address X = 0 is then located at the right side (column 101) of the display (see Fig.9). When MX = 0 the mirroring is disabled and the address X = 0 is located at the left side (column 0) of the display (see Fig.8).

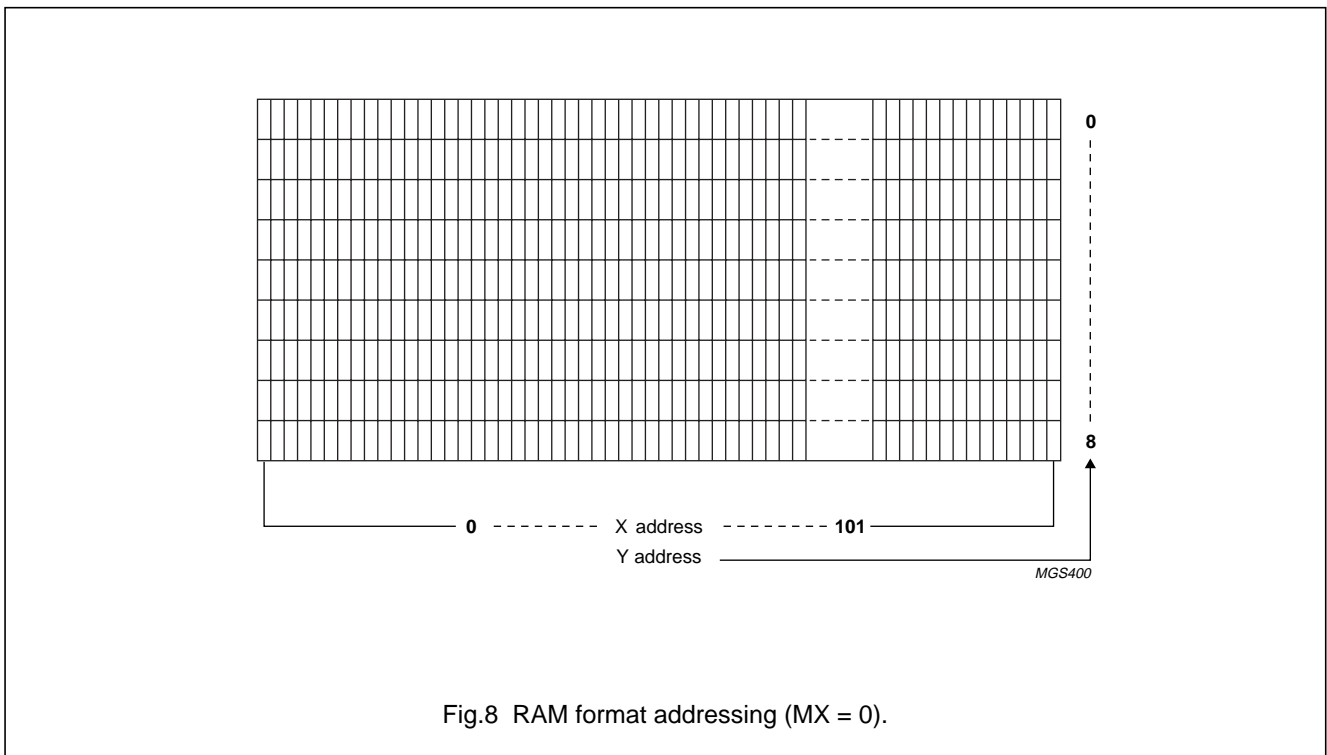

65 × 102 pixels matrix LCD driver

PCF8548

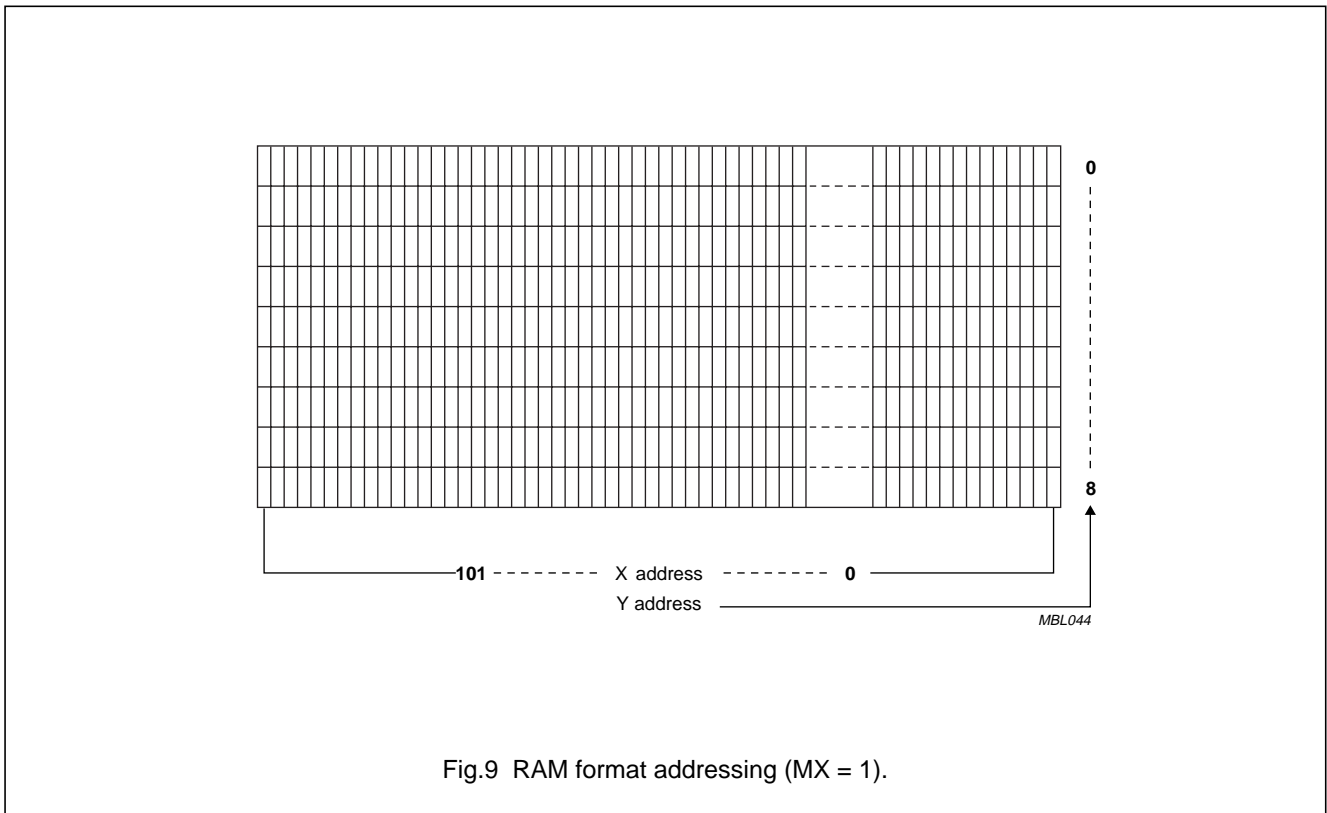

10.2 RAM access

If the  $D/\bar{C}$  bit is logic 1 the RAM can be written to. The data is written to the RAM during the acknowledge cycle.

# 65 × 102 pixels matrix LCD driver

# PCF8548

## 11 I<sup>2</sup>C-BUS INTERFACE

### 11.1 Characteristics of the I<sup>2</sup>C-bus

The I<sup>2</sup>C-bus is for bidirectional, two-line communication between different ICs or modules. The two lines are a Serial Data line (SDA) and a Serial Clock line (SCL). Both lines must be connected to a positive supply via a pull-up resistor. Data transfer may be initiated only when the bus is not busy.

#### 11.1.1 BIT TRANSFER

One data bit is transferred during each clock pulse. The data on the SDA line must remain stable during the HIGH period of the clock pulse because changes in the data line at this time will be interpreted as a control signal. Bit transfer is illustrated in Fig.10.

#### 11.1.2 START AND STOP CONDITIONS

Both data and clock lines remain HIGH when the bus is not busy. A HIGH-to-LOW transition of the data line, while the clock is HIGH is defined as the START condition (S). A LOW-to-HIGH transition of the data line while the clock is HIGH is defined as the STOP condition (P). The START and STOP conditions are illustrated in Fig.11.

#### 11.1.3 SYSTEM CONFIGURATION

The system configuration is illustrated in Fig.12.

- Transmitter: the device which sends the data to the bus
- Receiver: the device which receives the data from the bus
- Master: the device which initiates a transfer, generates clock signals and terminates a transfer

- Slave: the device addressed by a master
- Multi-Master: more than one master can attempt to control the bus at the same time without corrupting the message
- Arbitration: procedure to ensure that, if more than one master simultaneously tries to control the bus, only one is allowed to do so and the message is not corrupted
- Synchronization: procedure to synchronize the clock signals of two or more devices.

#### 11.1.4 ACKNOWLEDGE

Each byte of eight bits is followed by an acknowledge bit. The acknowledge bit is a HIGH signal put on the bus by the transmitter during which time the master generates an extra acknowledge related clock pulse. A slave receiver which is addressed must generate an acknowledge after the reception of each byte. A master receiver must also generate an acknowledge after the reception of each byte that has been clocked out of the slave transmitter.

The device that acknowledges must pull-down the SDA line during the acknowledge clock pulse, so that the SDA line is stable LOW during the HIGH period of the acknowledge related clock pulse (set-up and hold times must be taken into consideration). A master receiver must signal an end-of-data to the transmitter by not generating an acknowledge on the last byte that has been clocked out of the slave. In this event the transmitter must leave the data line HIGH to enable the master to generate a STOP condition. Acknowledgement on the I<sup>2</sup>C-bus is illustrated in Fig.13.

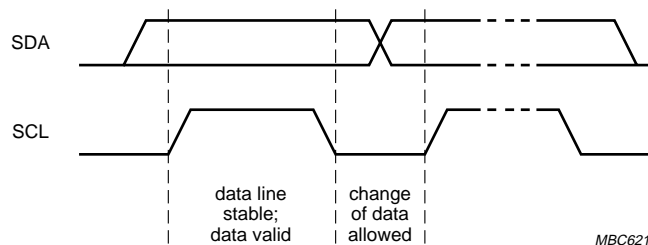

Fig.10 Bit transfer.

65 × 102 pixels matrix LCD driver

PCF8548

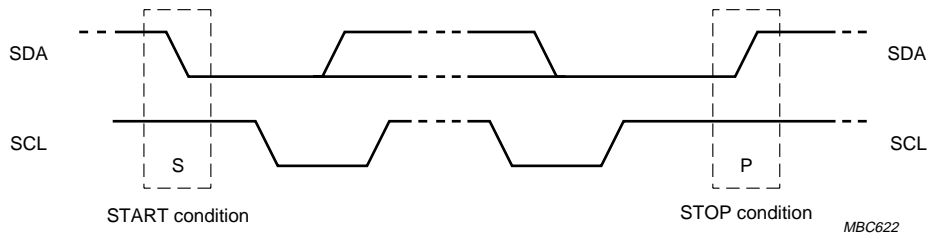

Fig.11 Definition of START and STOP conditions.

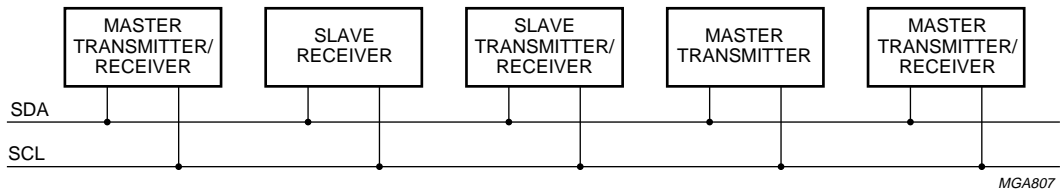

Fig.12 System configuration.

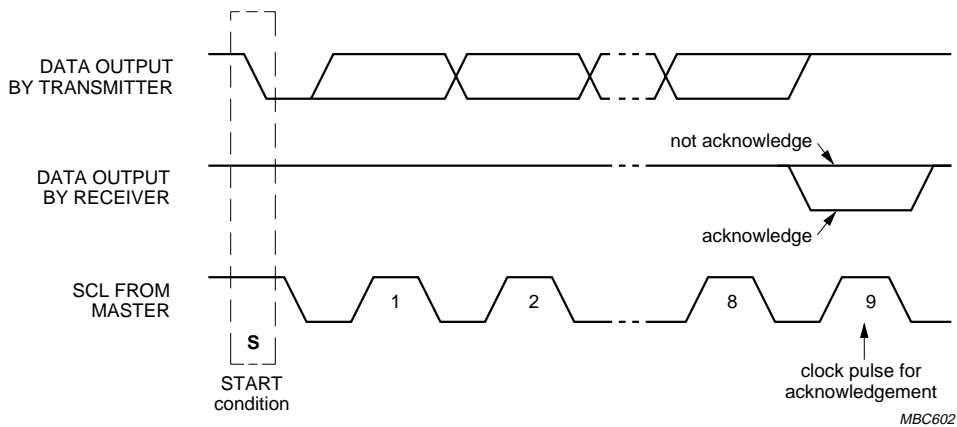

Fig.13 Acknowledgement on the I<sup>2</sup>C-bus.

65 × 102 pixels matrix LCD driver

PCF8548

11.2 I<sup>2</sup>C-bus protocol

The PCF8548 supports command, data write and status read access.

Before any data is transmitted on the I<sup>2</sup>C-bus, the device which should respond is addressed first. Two 7-bit slave addresses (0111100 and 0111101) are reserved for the PCF8548. The least significant bit of the slave address is set by connecting the input SA0 to either logic 0 (V<sub>SS1</sub>) or logic 1 (V<sub>DD1</sub>).

The I<sup>2</sup>C-bus protocol is illustrated in Fig.14.

The sequence is initiated with a START condition (S) from the I<sup>2</sup>C-bus master which is followed by the slave address. All slaves with the corresponding address acknowledge in parallel, all the others will ignore the I<sup>2</sup>C-bus transfer. After acknowledgement, one or more command words follow which define the status of the addressed slaves. A command word consists of a control byte, which defines Co and D/C, plus a data byte (see Fig.14 and Table 1).

The last control byte is tagged with a cleared most significant bit (i.e. the continuation bit Co). After a control byte with a cleared Co bit, only data bytes will follow. The state of the D/C bit defines whether the data byte is interpreted as a command or as RAM data.

The control and data bytes are also acknowledged by all addressed slaves on the bus.

After the last control byte, depending on the D/C bit setting, either a series of display data bytes or command data bytes may follow. If the D/C bit is set to logic 1, these display bytes are stored in the display RAM at the address specified by the data pointer. The data pointer is automatically updated and the data is directed to the intended PCF8548 device. If the D/C bit of the last control byte is set to logic 0, these command bytes will be decoded and the setting of the device will be changed according to the received commands. The acknowledgement after each byte is made only by the addressed slave. At the end of the transmission the I<sup>2</sup>C-bus master issues a STOP condition (P).

If the R/W bit is set to logic 1 the chip will output data immediately after the slave address if the D/C bit, which was sent during the last write access, is set to logic 0. If no acknowledge is generated by the master after a byte, the driver stops transferring data to the master.

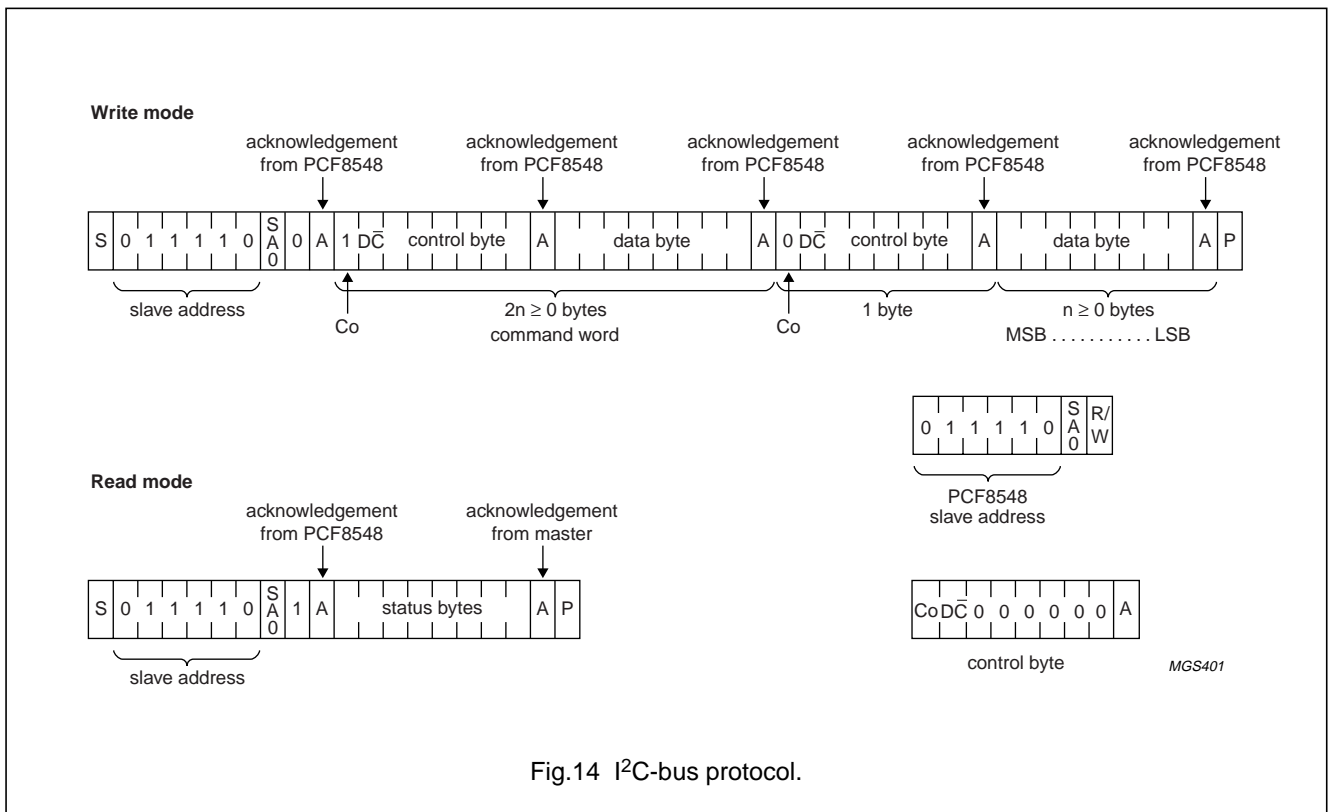

Fig.14 I<sup>2</sup>C-bus protocol.

## 65 × 102 pixels matrix LCD driver

## PCF8548

## 12 INSTRUCTIONS

The instruction format is divided into two modes:

1. If  $D/\bar{C}$  is set LOW, commands can be sent to the chip.
2. If  $D/\bar{C}$  is set HIGH, the DDRAM will be accessed.

Every instruction can be sent in any order to the PCF8548.

**Table 1** Instruction set

INSTRUCTION	$D/\bar{C}$	$R/\bar{W}$	COMMAND BYTE								DESCRIPTION	
			B7	B6	B5	B4	B3	B2	B1	B0		
<b>H = 0 or 1</b>												
NOP	0	0	0	0	0	0	0	0	0	0	0	no operation
Reserved	0	0	0	0	0	0	0	0	0	0	1	do not use
Function set	0	0	0	0	1	MX	MY	PD	V	H		Power-down control; entry mode; extended instruction set control (H)
Read status byte	0	1	PD	TRS	BRS	D	E	MX	MY	DO		read status byte
Write data	1	0	D <sub>7</sub>	D <sub>6</sub>	D <sub>5</sub>	D <sub>4</sub>	D <sub>3</sub>	D <sub>2</sub>	D <sub>1</sub>	D <sub>0</sub>		writes data to RAM
<b>H = 0</b>												
Reserved	0	0	0	0	0	0	0	0	1	X		do not use
Set V <sub>LCD</sub> range	0	0	0	0	0	0	0	1	0	PRS		V <sub>LCD</sub> programming range select
Display control	0	0	0	0	0	0	1	D	0	E		sets display configuration
Set HV-gen stages	0	0	0	0	0	1	0	0	S1	S0		# of HV-gen voltage multiplication
Set Y address of RAM	0	0	0	1	0	0	Y <sub>3</sub>	Y <sub>2</sub>	Y <sub>1</sub>	Y <sub>0</sub>		sets Y address of RAM: 0 ≤ Y ≤ 8
Set X address of RAM	0	0	1	X <sub>6</sub>	X <sub>5</sub>	X <sub>4</sub>	X <sub>3</sub>	X <sub>2</sub>	X <sub>1</sub>	X <sub>0</sub>		sets X address of RAM: 0 ≤ X ≤ 101
<b>H = 1</b>												
Reserved	0	0	0	0	0	0	0	0	1	X		do not use
Temperature control	0	0	0	0	0	0	0	1	TC <sub>1</sub>	TC <sub>0</sub>		set temperature coefficient (TCx)
Display configuration	0	0	0	0	0	0	1	DO	TRS	BRS		top/bottom row mode set data order
Bias system	0	0	0	0	0	1	0	BS <sub>2</sub>	BS <sub>1</sub>	BS <sub>0</sub>		set bias system (BSx)
Reserved	0	0	0	1	X	X	X	X	X	X		do not use (reserved for test)
Set V <sub>OP</sub>	0	0	1	V <sub>OP6</sub>	V <sub>OP5</sub>	V <sub>OP4</sub>	V <sub>OP3</sub>	V <sub>OP2</sub>	V <sub>OP1</sub>	V <sub>OP0</sub>		write V <sub>OP</sub> to register



## 65 × 102 pixels matrix LCD driver

PCF8548

**Table 2** Explanations of symbols in Table 1

BIT		0	1	RESET STATE
PD		chip is active	chip is in Power-down mode	1
V		horizontal addressing	vertical addressing	0
H		use basic instruction set	use extended instruction set	0
MX		normal X addressing	X address is mirrored	0
MY		display is not vertically mirrored	display is vertically mirrored	0
TRS		top rows are not mirrored	top rows are mirrored	0
BRS		bottom rows are not mirrored	bottom rows are mirrored	0
DO		MSB is on top	LSB is on top	0
PRS		V <sub>LCD</sub> programming range LOW	V <sub>LCD</sub> programming range HIGH	0
D and E	00	display blank		D = 0 E = 0
	10	normal mode		
	01	all display segments on		
	11	inverse video mode		
TC[1:0]	00	V <sub>LCD</sub> temperature coefficient 0		TC[1:0] = 00
	01	V <sub>LCD</sub> temperature coefficient 1		
	10	V <sub>LCD</sub> temperature coefficient 2		
	11	V <sub>LCD</sub> temperature coefficient 3		
S[1:0]	00	2 × voltage multiplier		S[1:0] = 00
	01	3 × voltage multiplier		
	10	4 × voltage multiplier		
	11	5 × voltage multiplier		
BS[2:0]		bias system		BS[2:0] = 000
V <sub>op</sub> [6:0]		V <sub>LCD</sub> programming		V <sub>op</sub> [6:0] = 0000000

**12.1 External reset (RES)**

After power-on a reset pulse must be applied immediately to the chip, as it is in an undefined state. A reset of the chip can be achieved using the external reset pad. After the reset the LCD driver is set to the following states:

- Power-down mode (PD = 1)
- All LCD outputs at V<sub>SS</sub> (display off)
- Horizontal addressing (V = 0)
- Normal instruction set (H = 0)
- Normal display (MX = MY = TRS = BRS = 0)
- Display blank (E = D = 0)
- Address counter X[6:0] = 0 and Y[3:0] = 0
- Temperature coefficient (TC[1:0] = 0)
- Bias system (BS[2:0] = 0)
- V<sub>LCD</sub> is equal to 0, the HV generator is switched off (V<sub>op</sub>[6:0] = 0 and PRS = 0)
- After power-on (RAM data is undefined), the reset signal does not change the content of the RAM.

65 × 102 pixels matrix LCD driver

PCF8548

12.2 Function set

12.2.1 POWER-DOWN (PD)

- All LCD outputs at V<sub>SS</sub> (display off)
- Bias generator and V<sub>LCD</sub> generator off
- Oscillator off (external clock possible)
- V<sub>LCD</sub> can be disconnected
- RAM contents not cleared (RAM data can be written)
- V<sub>LCD</sub> output is discharged to V<sub>SS</sub>.

12.2.2 V

When V = 0, the horizontal addressing is selected. The data is written to the RAM as shown in Fig.4. When V = 1, the vertical addressing is selected. The data is written to the RAM as shown in Fig.5.

12.2.3 H

When H = 0 the commands 'display control', 'set HV-gen stages', 'set Y address' and 'set X address' can be performed. When H = 1 the other commands can be executed. The commands 'write data' and 'function set' can be executed in both cases.

12.2.4 MX

When MX = 0, the display RAM is written from left to right (X = 0 is on the left side of the display, X = 100 is on the right side of the display). When MX = 1 the display RAM is written from right to left (X = 0 is on the right side of the display, X = 100 is on the left side of the display).

Thus, if a horizontally mirroring of the display is desired the RAM must first be rewritten.

12.2.5 MY

When MY = 1, the display is mirrored vertically.

A change of this bit has an immediate effect on the display.

12.3 Display control

12.3.1 D AND E

The bits D and E select the display mode (see Table 2).

12.4 Display configuration

12.4.1 TRS

Bit TRS enables the top row pad blocks to be mirrored. This is used to enable flexibility in the wiring of the row lines from the PCF8548 to the LCD cell (e.g. COG or TCP wiring). When TRS = 0 rows 19 to 32 and rows 51 to 64 are organized as illustrated in Fig.22. When TRS = 1 rows 19 to 32 and rows 51 to 64 are mirrored and organized as illustrated in Fig.23.

12.4.2 BRS

Bit BRS enables the bottom row pad blocks to be mirrored. This is used to enable flexibility in the wiring of the row lines from the PCF8548 to the LCD cell (e.g. COG or TCP wiring). When BRS = 0 rows 0 to 18 and rows 33 to 50 are organized as illustrated in Fig.22. When BRS = 1 rows 0 to 18 and rows 33 to 50 are mirrored and organized as illustrated in Fig.23.

12.5 Set Y address of RAM

Y[3 : 0] defines the Y address vector address of the RAM.

Table 3 X and Y address ranges

Y <sub>3</sub>	Y <sub>2</sub>	Y <sub>1</sub>	Y <sub>0</sub>	CONTENT	ALLOWED X RANGE
0	0	0	0	bank 0 (display RAM)	0 to 101
0	0	0	1	bank 1 (display RAM)	0 to 101
0	0	1	0	bank 2 (display RAM)	0 to 101
0	0	1	1	bank 3 (display RAM)	0 to 101
0	1	0	0	bank 4 (display RAM)	0 to 101
0	1	0	1	bank 5 (display RAM)	0 to 101
0	1	1	0	bank 6 (display RAM)	0 to 101
0	1	1	1	bank 7 (display RAM)	0 to 101
1	0	0	0	bank 8 (display RAM); note 1	0 to 101

Note

1. In bank 8 only the MSB is accessed.

# 65 × 102 pixels matrix LCD driver

# PCF8548

### 12.6 Set X address of RAM

The X address points to the columns. The range of X is 0 to 101 (65H).

### 12.7 Set HV generator stages

#### 12.7.1 S[1:0]

The PCF8548 incorporates a software configurable voltage multiplier. After reset the voltage multiplier is set to  $2 \times V_{DD2}$ . Other voltage multiplier factors are set via the command 'set HV-gen stages' (see Tables 1 and 2).

### 12.8 Temperature control

Due to the temperature dependency of the liquid crystals viscosity, the LCD controlling voltage  $V_{LCD}$  must be increased with lower temperature to maintain optimum contrast.

There are 4 different temperature coefficients available in the PCF8548 (see Fig.15). The coefficients are selected by the two bits TC[1:0]. Table 6 shows the typical values of the different temperature coefficients. The coefficients are proportional to the programmed  $V_{LCD}$ .

### 12.9 Bias system

The Bias voltage levels are set in the ratio of  $R - R - nR - R - R$  giving a  $\frac{1}{n+4}$  bias system.

The resulting bias levels are shown in Table 5.

Different multiplex rates require different factors n (see Table 4); this is programmed by BS[2 : 0]. For Mux 1 : 65 the optimum bias value n is given by:

$$n = \sqrt{m} - 3 = \sqrt{65} - 3 = 5.06 = 5 \text{ resulting in } \frac{1}{9}\text{bias.}$$

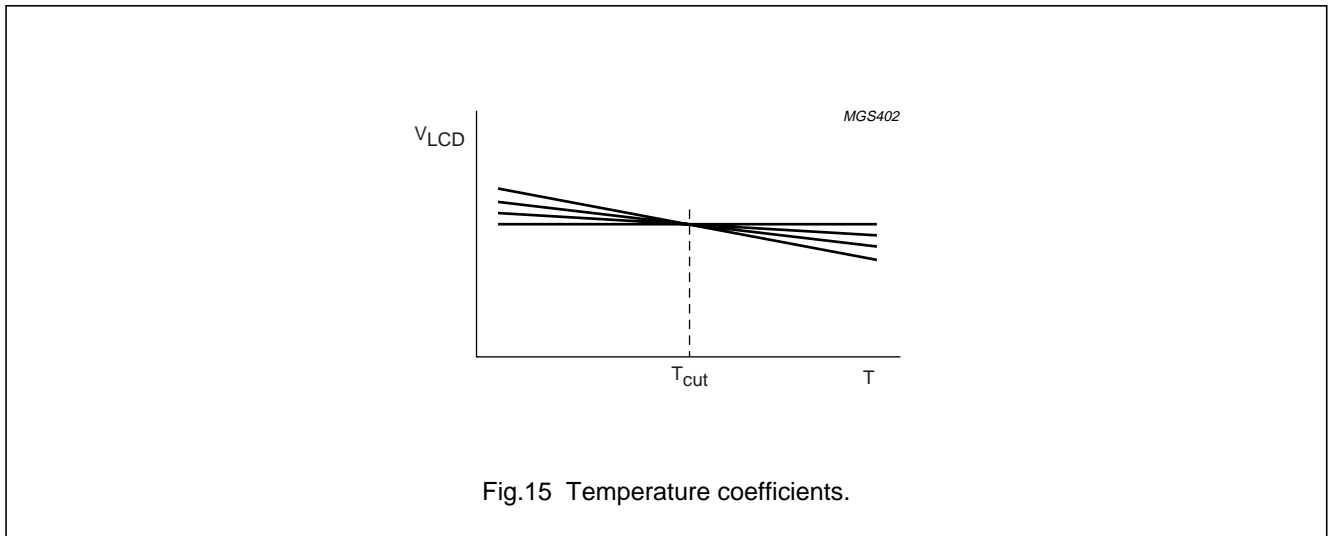

65 × 102 pixels matrix LCD driver

PCF8548

**Table 4** Programming the required bias system

BS[2]	BS[1]	BS[0]	n	RECOMMENDED MUX RATE
0	0	0	7	1 : 100
0	0	1	6	1 : 81
0	1	0	5	1 : 64
0	1	1	4	1 : 49
1	0	0	3	1 : 36
1	0	1	2	1 : 24
1	1	0	1	1 : 16
1	1	1	0	1 : 9

**Table 5** LCD bias voltage

SYMBOL	BIAS VOLTAGES	BIAS VOLTAGES FOR 1/9 BIAS
V1	V <sub>LCD</sub>	V <sub>LCD</sub>
V2	(n + 3)/(n + 4)	8/9 × V <sub>LCD</sub>
V3	(n + 2)/(n + 4)	7/9 × V <sub>LCD</sub>
V4	2/(n + 4)	2/9 × V <sub>LCD</sub>
V5	1/(n + 4)	1/9 × V <sub>LCD</sub>
V6	V <sub>SS</sub>	V <sub>SS</sub>

**12.10 Set V<sub>OP</sub> value**

The voltage at reference temperature can be calculated as: [V<sub>LCD</sub> (T = T<sub>cut</sub>)]

$$V_{LCD(T_{cut})} = (a + V_{OP} \times b) \tag{1}$$

The operating voltage V<sub>LCD</sub> can be set by software. The generated voltage is dependent on the temperature, programmed Temperature Coefficient (TC) and the programmed voltage at reference temperature (T<sub>cut</sub>).

$$V_{LCD} = (a + V_{OP} \times b) \times [1 + (T - T_{cut}) \times TC] \tag{2}$$

The parameters are explained in Fig.16 and Table 6. The maximum voltage that can be generated is dependent on the V<sub>DD2</sub> voltage and the display load current. Two overlapping V<sub>LCD</sub> ranges are selectable via the command 'HV-gen control'. For the LOW (PRS = 0) range a = a<sub>1</sub> and for the HIGH (PRS = 1) range a = a<sub>2</sub> with steps equal to b in both ranges. It should be noted that the charge pump is turned off if V<sub>OP</sub>[6;0] and bit PRS are all set to zero. For Mux 1 : 65 the optimum operation voltage of the liquid can be calculated as follows:

$$V_{LCD} = \frac{1 + \sqrt{65}}{\sqrt{2 \times \left(1 - \frac{1}{\sqrt{65}}\right)}} \times V_{th} = 6.85 \times V_{th}$$

where V<sub>th</sub> is the threshold voltage of the liquid crystal material used.

**Table 6** Typical values for parameters for the HV-generator programming

SYMBOL	BITS	VALUE	UNIT
a <sub>1</sub>		2.94 (PRS = 0)	V
a <sub>2</sub>		6.75 (PRS = 1)	V
b		0.03	V
T <sub>cut</sub>		27	°C

65 × 102 pixels matrix LCD driver

PCF8548

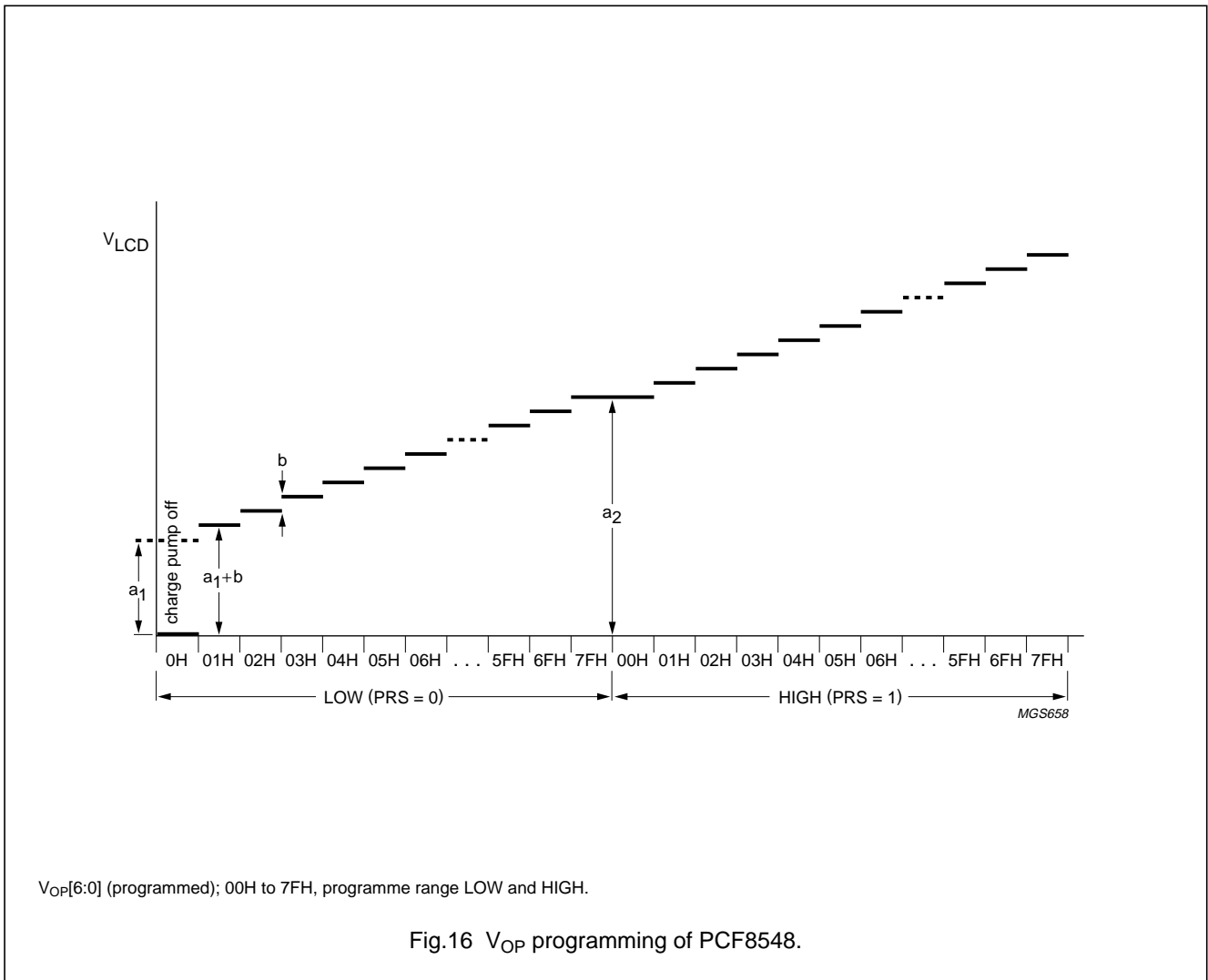

As the programming range for the internally generated  $V_{LCD}$  allows values above the maximum allowed  $V_{LCD}$  (9.0 V) the customer must ensure while setting the  $V_{OP}$  register and selecting the temperature coefficient, under all conditions and including all tolerances  $V_{LCD}$  remains below 9.0 V.

## 65 × 102 pixels matrix LCD driver

## PCF8548

**13 LIMITING VALUES**

Limiting values given are in accordance with the Absolute Maximum Rating System (IEC 134); parameters are valid over operating temperature range unless otherwise specified; all voltages referenced to  $V_{SS} = 0$  V. Stress above one or more of the limiting values may cause permanent damage to the device. These are stress ratings only and operation of the device at these or at any other conditions above those given in the characteristics sections of the specification is not implied. Exposure to limiting values for extended periods may affect device reliability.

SYMBOL	PARAMETER	MIN.	MAX.	UNIT
$V_{DD1}$	supply voltage	-0.5	+6.5	V
$V_{DD2}, V_{DD3}$	supply voltage for internal voltage generator	-0.5	+4.5	V
$V_{LCD}$	supply voltage for the LCD	-0.5	+9.0	V
$I_{SS}$	supply current	-50	+50	mA
$V_{i(n)}$	all input voltages	-0.5	$V_{DD} + 0.5$	V
$I_I$	DC input current	-10	+10	mA
$I_O$	DC output current	-10	+10	mA
$P_{pack}$	power dissipation per package	-	300	mW
$P/out$	power dissipation per output	-	30	mW

**14 HANDLING**

Inputs and outputs are protected against electrostatic discharge in normal handling. However, to be totally safe, it is desirable to take normal precautions appropriate to handling MOS devices (see "Handling MOS Devices").

**15 DC CHARACTERISTICS**

$V_{DD1} = 1.9$  to  $5.5$  V;  $V_{DD2}$  and  $V_{DD3} = 2.4$  to  $4.5$  V;  $V_{SS1}$  and  $V_{SS2} = 0$  V;  $V_{LCD} = 4.5$  to  $9.0$  V;  $T_{amb} = -40$  to  $+85$  °C; unless otherwise specified.

SYMBOL	PARAMETER	CONDITIONS	MIN.	TYP.	MAX.	UNIT
$V_{DD1}$	supply voltage		1.9	-	5.5	V
		$T_{amb} = -25$ to $+85$ °C	1.8	-	5.5	V
$V_{DD2}, V_{DD3}$	supply voltage for internal voltage generator	LCD voltage internally generated (voltage generator enabled)	2.4	-	4.5	V
$V_{LCDIN}$	LCD input supply voltage	LCD voltage externally supplied (voltage generator disabled)	4.5	-	9.0	V
$V_{LCDOUT}$	LCD output supply voltage	LCD voltage internally generated (voltage generator enabled); note 1	4.5	-	9.0	V
$I_{DD1}$	supply current	$V_{DD1} = 2.8$ V; $V_{LCD} = 7.6$ V; $f_{sclk} = 0$ ; $T_{amb} = 25$ °C; notes 2 and 3	-	20	-	μA
$I_{DD2}, I_{DD3}$	supply current for internal voltage generator	with external $V_{LCD}$	-	0.5	-	μA
		with internal $V_{LCD}$ generation; $V_{DD1} = 2.8$ V; $V_{LCD} = 7.6$ V; $f_{sclk} = 0$ ; $T_{amb} = 25$ °C; no display load; 4 × charge pump; notes 2 and 3	-	180	-	μA

65 × 102 pixels matrix LCD driver

PCF8548

SYMBOL	PARAMETER	CONDITIONS	MIN.	TYP.	MAX.	UNIT
I <sub>DD(tot)</sub>	total supply current	with internal V <sub>LCD</sub> generation; V <sub>DD1</sub> = 2.8 V; V <sub>LCD</sub> = 7.6 V; f <sub>sclk</sub> = 0; T <sub>amb</sub> = 25 °C; no display load; 4 × charge pump; notes 2 and 3	–	200	350	μA
		(Power-down mode) with internal or external V <sub>LCD</sub> generation; note 4	–	1.5	10	μA
I <sub>LCDIN</sub>	supply current from external V <sub>LCD</sub>	V <sub>DD1</sub> = 2.8 V; V <sub>LCD</sub> = 7.6 V; f <sub>sclk</sub> = 0; T <sub>amb</sub> = 25 °C; no display load; notes 2, 3 and 5	–	30	–	μA
<b>Logic</b>						
V <sub>IL</sub>	LOW-level input voltage		V <sub>SS1</sub>	–	0.3V <sub>DD1</sub>	V
V <sub>IH</sub>	HIGH-level input voltage		0.7V <sub>DD1</sub>	–	V <sub>DD1</sub>	V
I <sub>L</sub>	leakage current	V <sub>i</sub> = V <sub>DD1</sub> or V <sub>SS1</sub>	–1	–	+1	μA
<b>Column and row outputs</b>						
R <sub>row</sub>	row output resistance R0 to R64	V <sub>DD1</sub> to V <sub>DD3</sub> = 5.0 V; V <sub>LCD</sub> = 7.6 V; I <sub>L</sub> = 10 μA; outputs tested one at a time	–	12	20	kΩ
R <sub>col</sub>	column output resistance C0 to C101	V <sub>LCD</sub> = 7.6 V	–	12	20	kΩ
V <sub>bias(col)</sub>	column bias tolerance C0 to C101		–100	0	+100	mV
V <sub>bias(row)</sub>	row bias tolerance R0 to R64		–100	0	+100	mV
<b>LCD supply voltage generator</b>						
V <sub>LCD</sub>	V <sub>LCD</sub> tolerance internally generated	V <sub>DD1</sub> = 2.8 V; V <sub>LCD</sub> = 7.6 V; f <sub>sclk</sub> = 0; T <sub>amb</sub> = 25 °C; no display load; notes 2, 3 6 and 7	–300	0	+300	mV
TC	temperature coefficient	00	–	–0.0 × 10 <sup>–3</sup>	–	1/°C
		01	–	–0.76 × 10 <sup>–3</sup>	–	1/°C
		10	–	–1.05 × 10 <sup>–3</sup>	–	1/°C
		11	–	–2.10 × 10 <sup>–3</sup>	–	1/°C

**Notes**

1. The maximum possible V<sub>LCD</sub> voltage that can be generated is dependent on voltage, temperature and (display) load.
2. Internal clock.
3. When f<sub>sclk</sub> = 0 there is no I<sup>2</sup>C-bus clock.
4. Power-down mode. During power-down all static currents are switched off.
5. If external V<sub>LCD</sub>, the display load current is not transmitted to I<sub>DD</sub>.
6. Tolerance depends on the temperature; (typically zero at T<sub>amb</sub> = 27 °C), maximum tolerance values are measured at the temperature range limit.
7. For TC0 to TC3.

## 65 × 102 pixels matrix LCD driver

## PCF8548

**16 AC CHARACTERISTICS**

$V_{DD1} = 1.9$  to  $5.5$  V;  $V_{DD2}$  and  $V_{DD3} = 2.4$  to  $4.5$  V;  $V_{SS1}$  and  $V_{SS2} = 0$  V;  $V_{LCD} = 4.5$  to  $9$  V;  $T_{amb} = -40$  to  $+85$  °C; unless otherwise specified.

SYMBOL	PARAMETER	CONDITIONS	MIN.	TYP.	MAX.	UNIT
$f_{OSC}$	oscillator frequency	$V_{DD1} = 2.8$ V; $T_{amb} = -20$ to $+70$ °C	20	38	70	kHz
$f_{clk(ext)}$	external clock frequency		20	38	100	kHz
$f_{frame}$	frame frequency	$f_{OSC}$ or $f_{clk(ext)} = 38$ kHz; note 1	–	73	–	Hz
$t_{VHRL}$	$V_{DD1}$ to $\overline{RES}$ LOW	see Fig.17 and note 2	0	–	1	µs
$t_{W(RES)}$	$\overline{RES}$ LOW pulse width	see Fig.17 and note 3	100	–	–	ns
<b>I<sup>2</sup>C-bus timing characteristics; see note 4</b>						
$f_{SCLK}$	SCL clock frequency		0	–	400	kHz
$t_{SCLL}$	SCL clock LOW period		1.3	–	–	µs
$t_{SCLH}$	SCL clock HIGH period		0.6	–	–	µs
$t_{SU;DAT}$	data set-up time		100	–	–	ns
$t_{HD;DAT}$	data hold time		0	–	0.9	µs
$t_r$	SCL and SDA rise time	note 5	$20 + 0.1C_b$	–	300	ns
$t_f$	SCL and SDA fall time	note 5	$20 + 0.1C_b$	–	300	ns
$t_{f(SDA)(ro)}$	SDA fall time for read out	$V_{DD1} = <3.6$ V	$20 + 0.1C_b$	–	1000	ns
$C_b$	capacitive load represented by each bus line		–	–	400	pF
$t_{SU;STA}$	set-up time for a repeated START condition		0.6	–	–	µs
$t_{HD;STA}$	START condition hold time		0.6	–	–	µs
$t_{SU;STO}$	set-up time for STOP condition		0.6	–	–	µs
$t_{SW}$	tolerable spike width on bus	note 6	–	–	50	ns
$t_{BUF}$	bus free time between a STOP and START condition		1.3	–	–	µs

**Notes**

- $f_{frame} = \frac{f_{clk(ext)}}{520}$
- $\overline{RES}$  may be LOW before  $V_{DD1}$  goes HIGH.
- If  $t_{W(RES)}$  is longer than 3 ns (typical) a reset may be generated.
- All timing values are valid within the operating supply voltage and ambient temperature ranges and are referenced to  $V_{IL}$  and  $V_{IH}$  with an input voltage swing of  $V_{SS}$  to  $V_{DD}$ .
- The rise and fall times specified here refer to the driver device (i.e. not PCF8548) and are part of the general fast I<sup>2</sup>C-bus specification. When PCF8548 asserts an acknowledge on SDA, the minimum fall time is 10 ns.  
 $C_b$  = capacitive load per bus line.
- The device inputs SDA and SCL are filtered and will reject spikes on the bus lines of width  $<t_{SW(max)}$ .



65 × 102 pixels matrix LCD driver

PCF8548

17 RESET

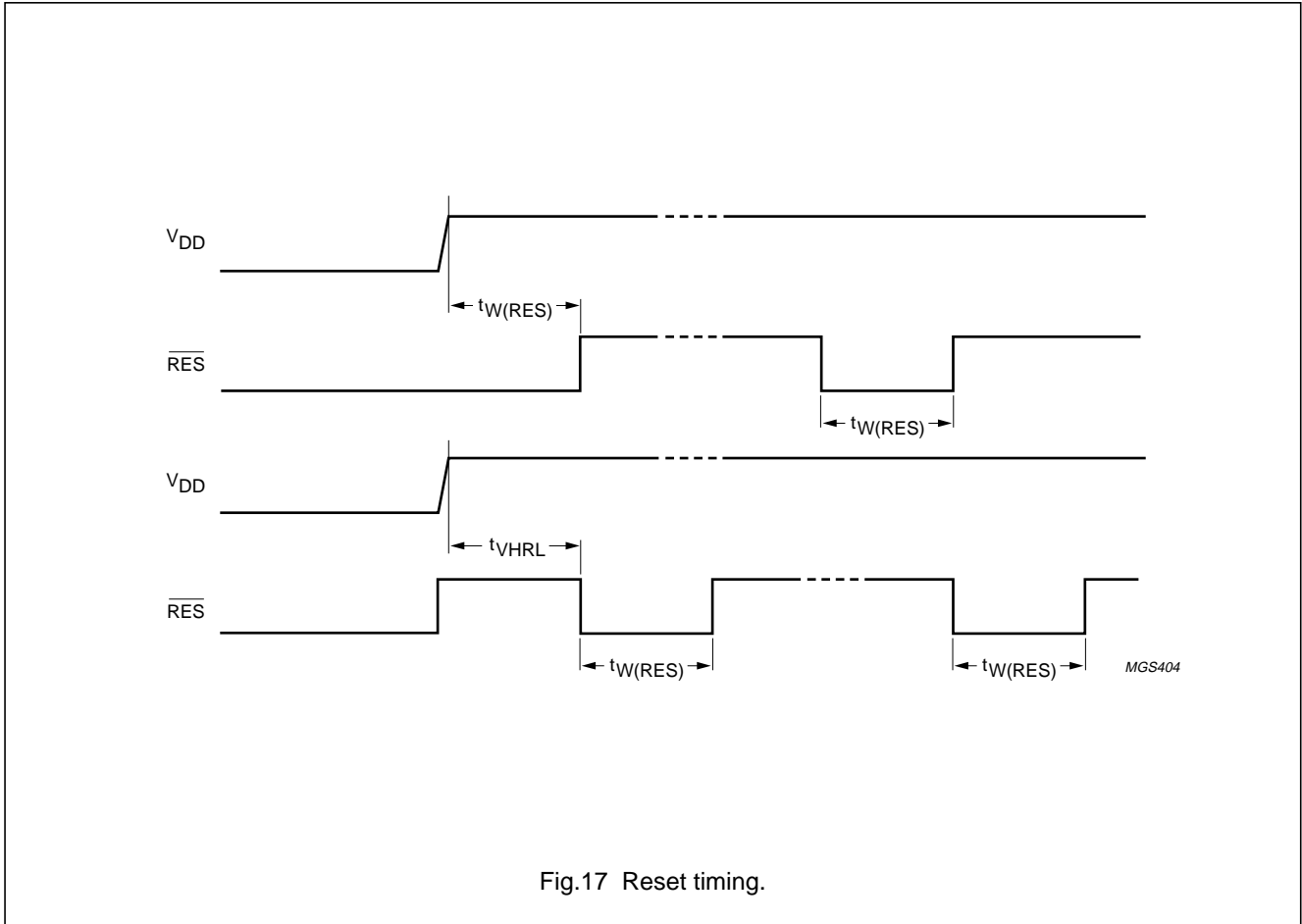

Fig.17 Reset timing.

## 65 × 102 pixels matrix LCD driver

## PCF8548

## 18 APPLICATION INFORMATION

Table 7 Programming example for PCF8548

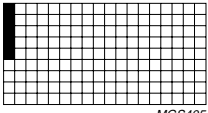
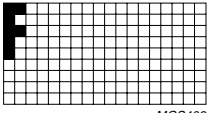
STEP	BITS								DISPLAY	OPERATION
	B7	B6	B5	B4	B3	B2	B1	B0		
1	I <sup>2</sup> C-bus start									
2	0	1	1	1	1	0	0	0		slave address for write
3	0	0	0	0	0	0	0	0		control byte with cleared Co bit and D/C set to logic 0
4	0	0	1	0	0	0	0	1		function set; PD = 0; V = 0; select extended instruction set (H = 1 mode)
5	0	0	0	1	0	0	1	0		set bias system 2; this is the recommended bias system for a multiplex rate 1 : 65
6	1	1	1	0	1	0	1	0		set V <sub>OP</sub> ; V <sub>OP</sub> is set to a +106 × b [V]; it should be noted that the required voltage is dependent on the liquid
7	0	0	1	0	0	0	0	0		function set; PD = 0; V = 0; select normal instruction set (H = 0 mode)
8	0	0	0	0	1	1	0	0		display control; set normal mode (D = 1; E = 0)
9	I <sup>2</sup> C-bus start									restart; to write into the display RAM the D/C must be set to logic 1; therefore a control byte is needed
10	0	1	1	1	1	0	0	0		slave address for write
11	0	1	0	0	0	0	0	0		control byte with cleared Co bit and D/C set to logic 1
12	1	1	1	1	1	0	0	0	 MGS405	data write; Y and X are initialized to 0 by default, so they are not set here
13	1	0	1	0	0	0	0	0	 MGS406	data write

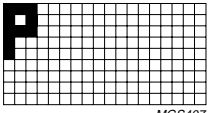
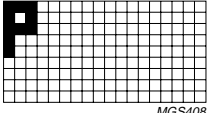
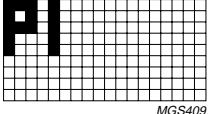
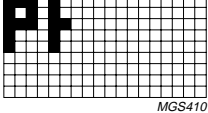
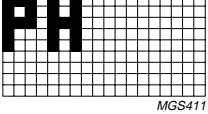
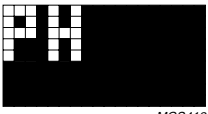
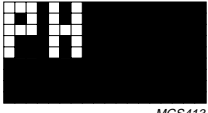

65 × 102 pixels matrix LCD driver

PCF8548

STEP	BITS								DISPLAY	OPERATION
	B7	B6	B5	B4	B3	B2	B1	B0		
14	1	1	1	0	0	0	0	0		data write
15	0	0	0	0	0	0	0	0		data write
16	1	1	1	1	1	0	0	0		data write
17	0	0	1	0	0	0	0	0		data write
18	1	1	1	1	1	0	0	0		data write
19	I <sup>2</sup> C-bus start									restart
20	0	1	1	1	1	0	0	0		slave address for write
21	1	0	0	0	0	0	0	0		control byte with set Co bit and D/C set to logic 0
22	0	0	0	0	1	1	0	1		display control; set inverse video mode (D = 1; E = 1)
23	1	0	0	0	0	0	0	0		control byte with set Co bit and D/C set to logic 0
24	1	0	0	0	0	0	0	0		set X address of RAM; set address to '000000'

65 × 102 pixels matrix LCD driver

PCF8548

STEP	BITS								DISPLAY	OPERATION
	B7	B6	B5	B4	B3	B2	B1	B0		
25	1	1	0	0	0	0	0	0		control byte with set Co bit and D/C set to logic 1
26	0	0	0	0	0	0	0	0		data write
27	0	0	0	0	0	0	0	0		control byte with cleared Co bit and D/C set to logic 0
28	1	0	0	0	0	0	0	0		set X address of RAM; set address to '0000000'
29	I <sup>2</sup> C-bus start									restart
30	0	1	1	1	1	0	0	0		slave address for write
31	1	1	0	0	0	0	0	0		control byte with set Co bit and D/C set to logic 1
32	1	1	1	1	1	0	0	0		write data
33	1	0	0	0	0	0	0	0		control byte with set Co bit and D/C set to logic 0

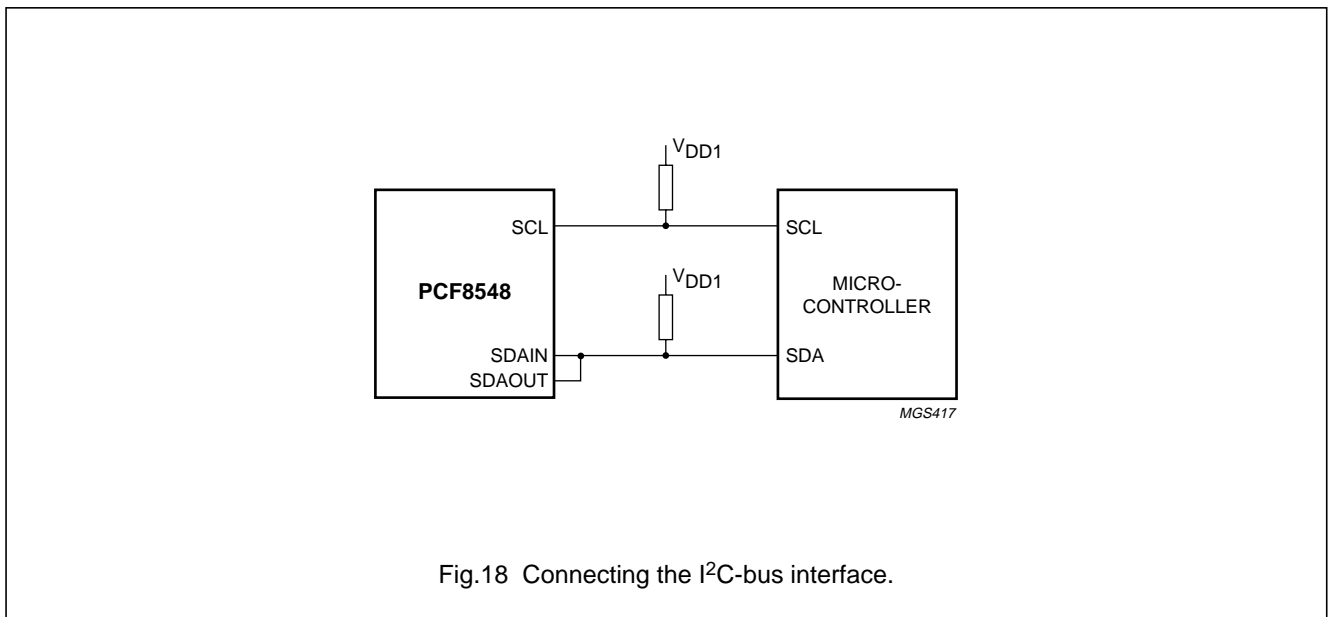

65 × 102 pixels matrix LCD driver

PCF8548

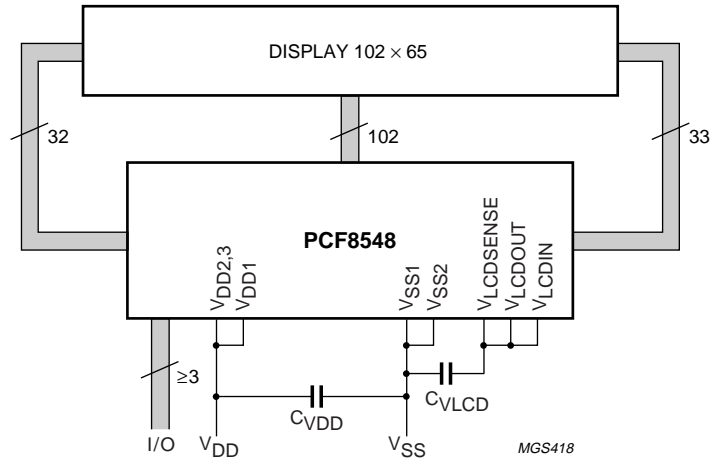

The number of I/Os depends on the application.

Fig.19 Internal charge pump is used and a single supply voltage.

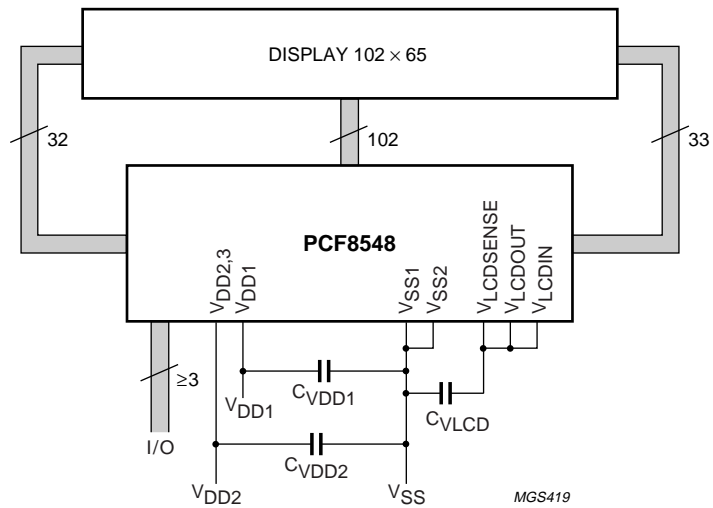

The number of I/Os depends on the application.

Fig.20 Internal charge pump is used and two separate supply voltages.

65 × 102 pixels matrix LCD driver

PCF8548

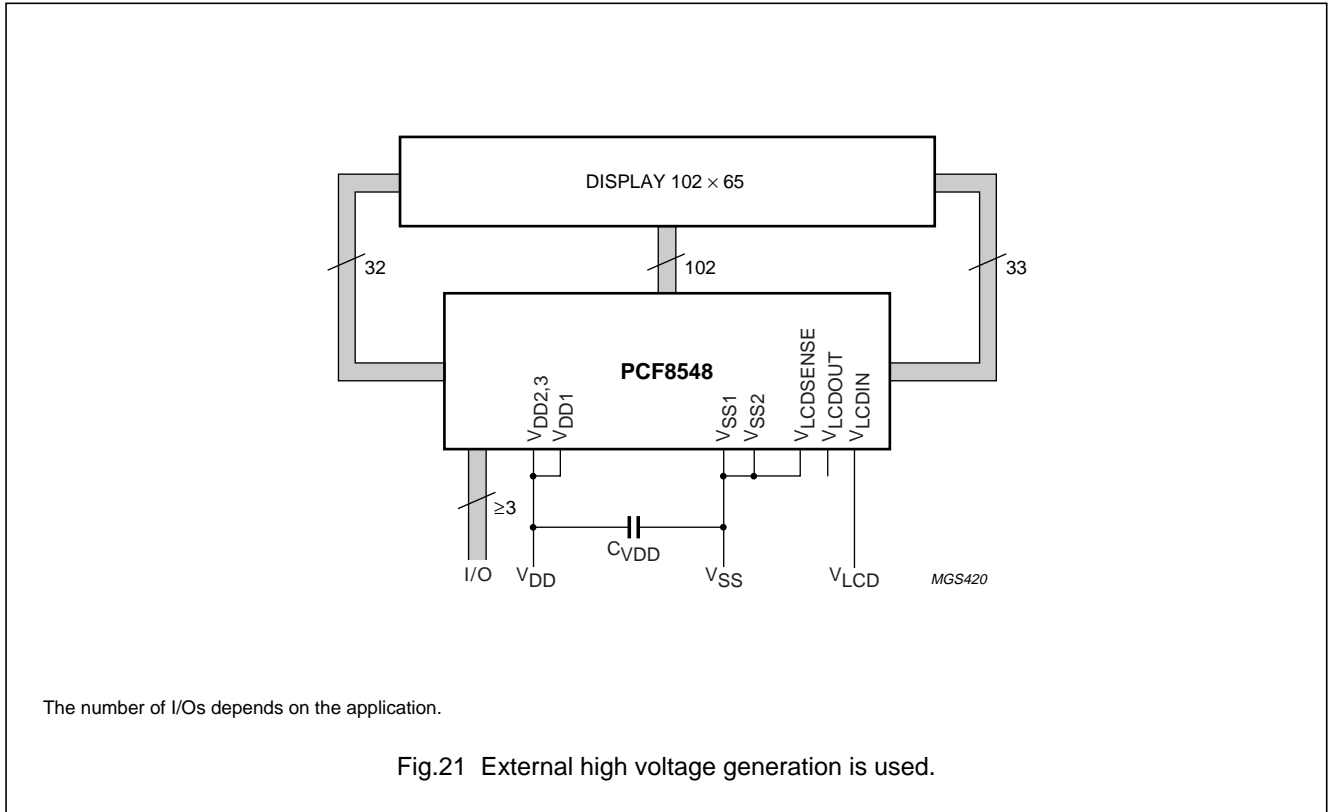

The pinning of the PCF8548 is optimized for single plane wiring e.g. for chip-on-glass display modules, or for TCP. Display size: 65 × 102 pixels. The required minimum value for the external capacitors in an application with the PCF8548 are:  $C_{VDD}$ ,  $C_{VDD1}$ ,  $C_{VDD2}$  and  $C_{V_{LCD}} = 1.0 \mu\text{F}$  (min.). Higher capacitor values are recommended for ripple reduction.

To reduce the sensitivity of the reset to ESD/EMC disturbances for a COG application, it is strongly recommended to implement on the glass (ITO) a series input resistance in the reset line (The recommended minimum value is 8 kΩ).

19 CHIP INFORMATION

The PCF8548 is manufactured in n-well CMOS technology. The substrate is at  $V_{SS}$  potential.

20 PAD INFORMATION

PAD	VALUE	UNIT
Minimum bump pitch	70	μm
Pad size, alumin	62 × 100	μm
Bumps	50 (±6) × 90 (±6) × 17.5 (±5)	μm
Wafer thickness without bumps	U/2 = 381; U/9 = 525	μm

## 65 × 102 pixels matrix LCD driver

## PCF8548

**Table 8** Bonding pad location

All x and y coordinates are referenced to the centre of the chip (dimension in  $\mu\text{m}$ ; see Fig.22).

SYMBOL	PAD	x	y
RES	1	+1160	+899.4
SDAOUT	2	+840	+899.4
SDAIN	3	+600	+899.4
SDAIN	4	+520	+899.4
SCL	5	+200	+899.4
SCL	6	+120	+899.4
T2	7	-200	+899.4
SA0	8	-410	+899.4
T7	9	-620	+899.4
T6	10	-830	+899.4
T5	11	-1040	+899.4
T4	12	-1250	+899.4
T3	13	-1460	+899.4
T1	14	-1670	+899.4
V <sub>SS1</sub>	15	-1750	+899.4
V <sub>SS1</sub>	16	-1830	+899.4
V <sub>SS1</sub>	17	-1910	+899.4
V <sub>SS1</sub>	18	-1990	+899.4
V <sub>SS1</sub>	19	-2070	+899.4
V <sub>SS1</sub>	20	-2150	+899.4
V <sub>SS2</sub>	21	-2310	+899.4
V <sub>SS2</sub>	22	-2390	+899.4
V <sub>SS2</sub>	23	-2470	+899.4
V <sub>SS2</sub>	24	-2550	+899.4
V <sub>SS2</sub>	25	-2630	+899.4
V <sub>SS2</sub>	26	-2710	+899.4
dummy pad	27	-2790	+899.4
V <sub>LCDOUT</sub>	28	-2950	+899.4
V <sub>LCDOUT</sub>	29	-3030	+899.4
V <sub>LCDOUT</sub>	30	-3110	+899.4
V <sub>LCDOUT</sub>	31	-3190	+899.4
V <sub>LCDOUT</sub>	32	-3270	+899.4
V <sub>LCDOUT</sub>	33	-3350	+899.4
V <sub>LCDSENSE</sub>	34	-3430	+899.4
V <sub>LCDIN</sub>	35	-3510	+899.4
V <sub>LCDIN</sub>	36	-3590	+899.4
V <sub>LCDIN</sub>	37	-3670	+899.4
V <sub>LCDIN</sub>	38	-3750	+899.4
V <sub>LCDIN</sub>	39	-3830	+899.4
V <sub>LCDIN</sub>	40	-3910	+899.4

SYMBOL	PAD	x	y
R32	41	-4235	+899.4
R31	42	-4305	+899.4
R30	43	-4375	+899.4
R29	44	-4445	+899.4
R28	45	-4515	+899.4
R27	46	-4585	+899.4
R26	47	-4655	+899.4
R25	48	-4725	+899.4
R24	49	-4795	+899.4
R23	50	-4865	+899.4
R22	51	-4935	+899.4
R21	52	-5005	+899.4
R20	53	-5075	+899.4
R19	54	-5145	+899.4
dummy pad	55	-5355	+899.4
dummy pad	56	-5320	-899.4
R0	57	-5040	-899.4
R1	58	-4970	-899.4
R2	59	-4900	-899.4
R3	60	-4830	-899.4
R4	61	-4760	-899.4
R5	62	-4690	-899.4
R6	63	-4620	-899.4
R7	64	-4550	-899.4
R8	65	-4480	-899.4
R9	66	-4410	-899.4
R10	67	-4340	-899.4
R11	68	-4270	-899.4
R12	69	-4200	-899.4
R13	70	-4130	-899.4
R14	71	-4060	-899.4
R15	72	-3990	-899.4
R16	73	-3920	-899.4
R17	74	-3850	-899.4
R18	75	-3780	-899.4
C0	76	-3570	-899.4
C1	77	-3500	-899.4
C2	78	-3430	-899.4
C3	79	-3360	-899.4
C4	80	-3290	-899.4

## 65 × 102 pixels matrix LCD driver

## PCF8548

SYMBOL	PAD	x	y
C5	81	-3220	-899.4
C6	82	-3150	-899.4
C7	83	-3080	-899.4
C8	84	-3010	-899.4
C9	85	-2940	-899.4
C10	86	-2870	-899.4
C11	87	-2800	-899.4
C12	88	-2730	-899.4
C13	89	-2660	-899.4
C14	90	-2590	-899.4
C15	91	-2520	-899.4
C16	92	-2450	-899.4
C17	93	-2380	-899.4
C18	94	-2310	-899.4
C19	95	-2240	-899.4
C20	96	-2170	-899.4
C21	97	-2100	-899.4
C22	98	-2030	-899.4
C23	99	-1960	-899.4
C24	100	-1890	-899.4
C25	101	-1750	-899.4
C26	102	-1680	-899.4
C27	103	-1610	-899.4
C28	104	-1540	-899.4
C29	105	-1470	-899.4
C30	106	-1400	-899.4
C31	107	-1330	-899.4
C32	108	-1260	-899.4
C33	109	-1190	-899.4
C34	110	-1120	-899.4
C35	111	-1050	-899.4
C36	112	-980	-899.4
C37	113	-910	-899.4
C38	114	-840	-899.4
C39	115	-770	-899.4
C40	116	-700	-899.4
C41	117	-630	-899.4
C42	118	-560	-899.4
C43	119	-490	-899.4
C44	120	-420	-899.4
C45	121	-350	-899.4
C46	122	-280	-899.4

SYMBOL	PAD	x	y
C47	123	-210	-899.4
C48	124	-140	-899.4
C49	125	-70	-899.4
C50	126	+0	-899.4
C51	127	+140	-899.4
C52	128	+210	-899.4
C53	129	+280	-899.4
C54	130	+350	-899.4
C55	131	+420	-899.4
C56	132	+490	-899.4
C57	133	+560	-899.4
C58	134	+630	-899.4
C59	135	+700	-899.4
C60	136	+770	-899.4
C61	137	+840	-899.4
C62	138	+910	-899.4
C63	139	+980	-899.4
C64	140	+1050	-899.4
C65	141	+1120	-899.4
C66	142	+1190	-899.4
C67	143	+1260	-899.4
C68	144	+1330	-899.4
C69	145	+1400	-899.4
C70	146	+1470	-899.4
C71	147	+1540	-899.4
C72	148	+1610	-899.4
C73	149	+1680	-899.4
C74	150	+1750	-899.4
C75	151	+1820	-899.4
C76	152	+1890	-899.4
C77	153	+2030	-899.4
C78	154	+2100	-899.4
C79	155	+2170	-899.4
C80	156	+2240	-899.4
C81	157	+2310	-899.4
C82	158	+2380	-899.4
C83	159	+2450	-899.4
C84	160	+2520	-899.4
C85	161	+2590	-899.4
C86	162	+2660	-899.4
C87	163	+2730	-899.4
C88	164	+2800	-899.4



65 × 102 pixels matrix LCD driver

PCF8548

SYMBOL	PAD	x	y
C89	165	+2870	-899.4
C90	166	+2940	-899.4
C91	167	+3010	-899.4
C92	168	+3080	-899.4
C93	169	+3150	-899.4
C94	170	+3220	-899.4
C95	171	+3290	-899.4
C96	172	+3360	-899.4
C97	173	+3430	-899.4
C98	174	+3500	-899.4
C99	175	+3570	-899.4
C100	176	+3640	-899.4
C101	177	+3710	-899.4
R50	178	+3850	-899.4
R49	179	+3920	-899.4
R48	180	+3990	-899.4
R47	181	+4060	-899.4
R46	182	+4130	-899.4
R45	183	+4200	-899.4
R44	184	+4270	-899.4
R43	185	+4340	-899.4
R42	186	+4410	-899.4
R41	187	+4480	-899.4
R40	188	+4550	-899.4
R39	189	+4620	-899.4
R38	190	+4690	-899.4
R37	191	+4760	-899.4
R36	192	+4830	-899.4
R35	193	+4900	-899.4
R34	194	+4970	-899.4
R33	195	+5040	-899.4
dummy pad	196	+5320	-899.4
dummy pad	197	+5355	+899.4
R51	198	+5145	+899.4
R52	199	+5075	+899.4
R53	200	+5005	+899.4
R54	201	+4935	+899.4
R55	202	+4865	+899.4
R56	203	+4795	+899.4
R57	204	+4725	+899.4
R58	205	+4655	+899.4
R59	206	+4585	+899.4

SYMBOL	PAD	x	y
R60	207	+4515	+899.4
R61	208	+4445	+899.4
R62	209	+4375	+899.4
R63	210	+4305	+899.4
R64	211	+4235	+899.4
T12	212	+3880	+899.4
T11	213	+3720	+899.4
T10	214	+3560	+899.4
T9	215	+3400	+899.4
OSC	216	+3160	+899.4
T8	217	+2680	+899.4
V <sub>DD1</sub>	218	+2600	+899.4
V <sub>DD1</sub>	219	+2520	+899.4
V <sub>DD1</sub>	220	+2440	+899.4
V <sub>DD1</sub>	221	+2360	+899.4
V <sub>DD1</sub>	222	+2280	+899.4
V <sub>DD1</sub>	223	+2200	+899.4
V <sub>DD3</sub>	224	+2120	+899.4
V <sub>DD3</sub>	225	+2040	+899.4
V <sub>DD3</sub>	226	+1960	+899.4
V <sub>DD2</sub>	227	+1880	+899.4
V <sub>DD2</sub>	228	+1800	+899.4
V <sub>DD2</sub>	229	+1720	+899.4
V <sub>DD2</sub>	230	+1640	+899.4
V <sub>DD2</sub>	231	+1560	+899.4
V <sub>DD2</sub>	232	+1480	+899.4
V <sub>DD2</sub>	233	+1400	+899.4

**Table 9** Alignment marks

x	y	MARKS
+5214	-899.4	mark 1
-5214	-899.4	mark 2
+4099	+899.4	mark 3
-4099	+899.4	mark 4

The alignment marks are circular with a diameter of 100 µm.

65 × 102 pixels matrix LCD driver

PCF8548

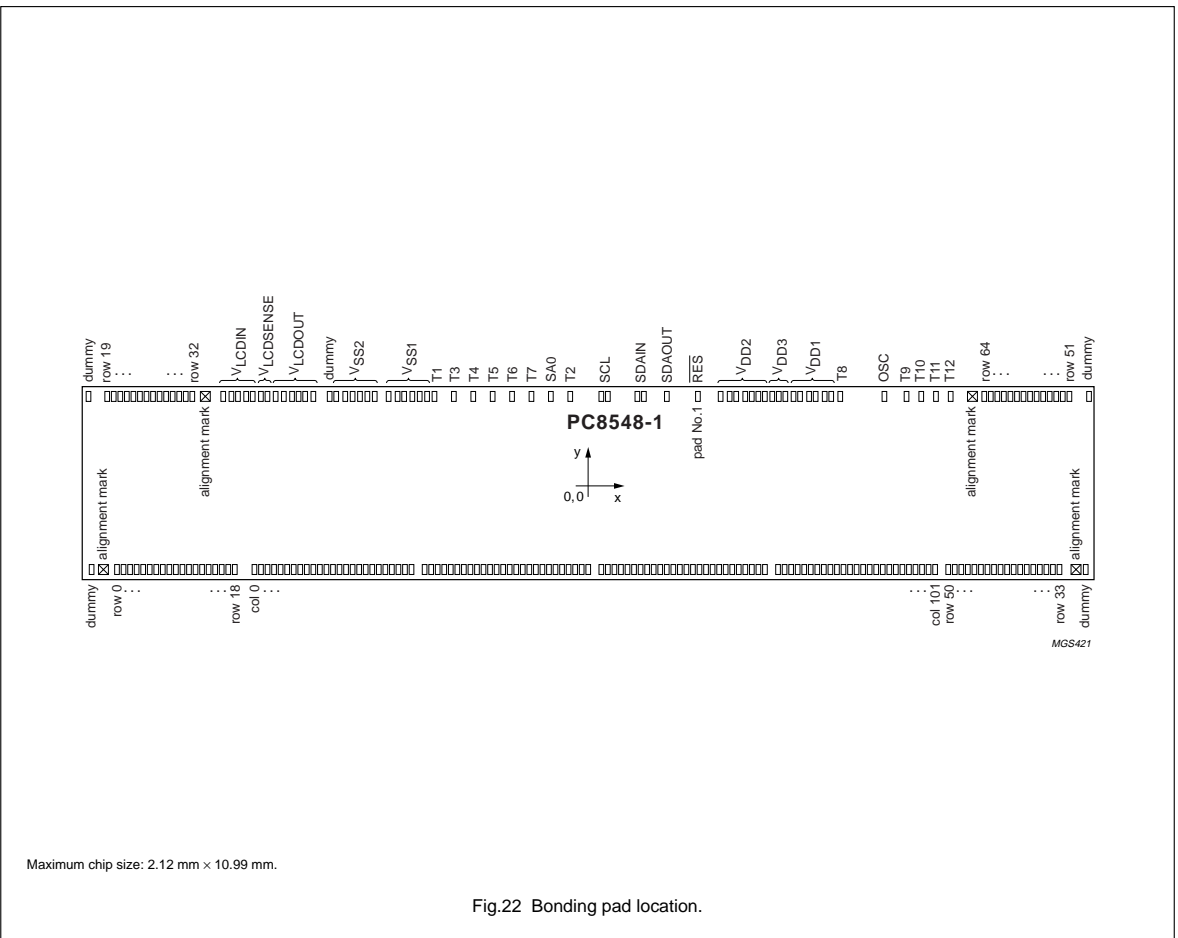

65 × 102 pixels matrix LCD driver

PCF8548

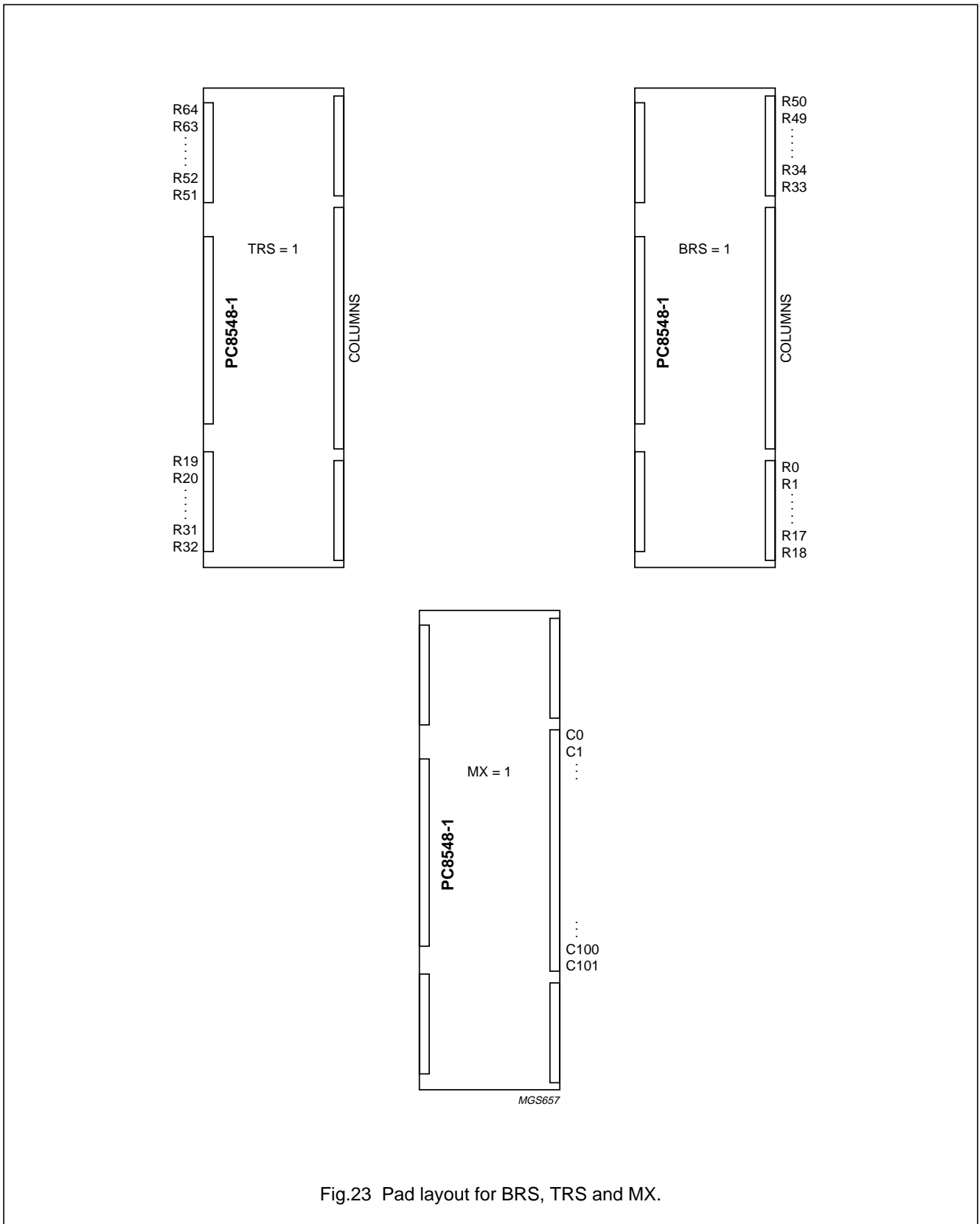

Fig.23 Pad layout for BRS, TRS and MX.

65 × 102 pixels matrix LCD driver

PCF8548

21 DEVICE PROTECTION DIAGRAM

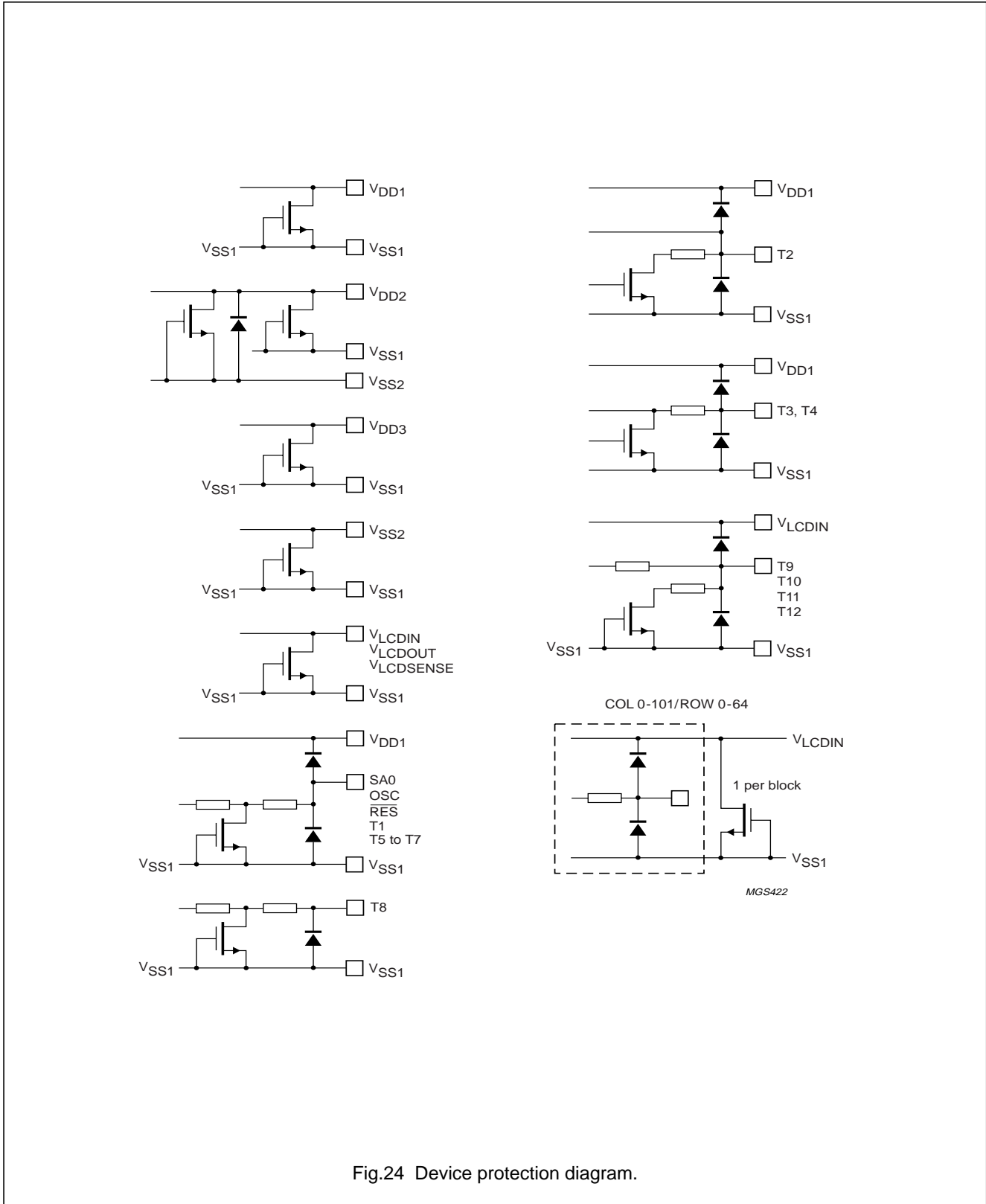

Fig.24 Device protection diagram.

65 × 102 pixels matrix LCD driver

PCF8548

22 TRAY INFORMATION

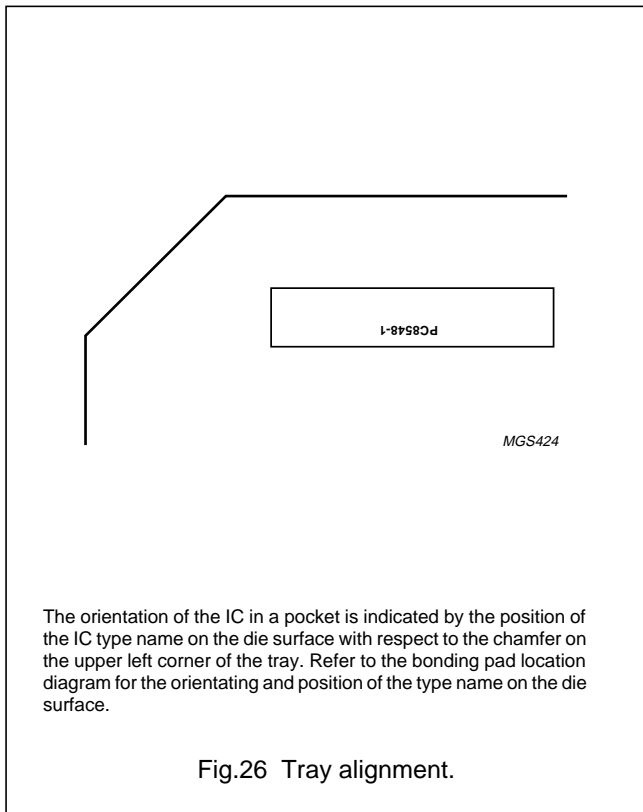
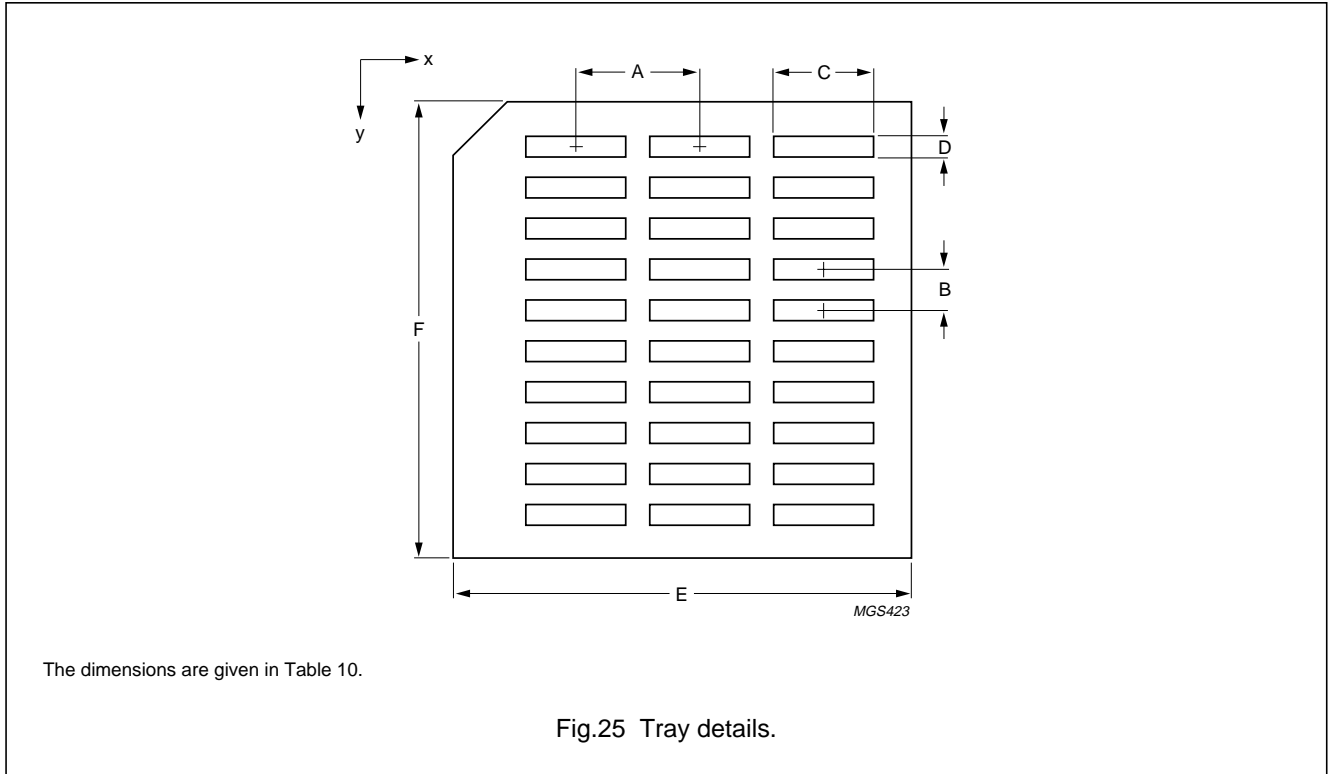

Table 10 Dimensions

DIM.	DESCRIPTION	VALUE
A	pocket pitch, x direction	13.77 mm
B	pocket pitch, y direction	4.45 mm
C	pocket width, x direction	11.09 mm
D	pocket width, y direction	2.3 mm
E	tray width, x direction	50.8 mm
F	tray width, y direction	50.8 mm
x	number of pockets in x direction	3
y	number of pockets in y direction	10

## 65 × 102 pixels matrix LCD driver

PCF8548

**23 DEFINITIONS**

<b>Data sheet status</b>	
Objective specification	This data sheet contains target or goal specifications for product development.
Preliminary specification	This data sheet contains preliminary data; supplementary data may be published later.
Product specification	This data sheet contains final product specifications.
<b>Application information</b>	
Where application information is given, it is advisory and does not form part of the specification.	

**24 LIFE SUPPORT APPLICATIONS**

These products are not designed for use in life support appliances, devices, or systems where malfunction of these products can reasonably be expected to result in personal injury. Philips customers using or selling these products for use in such applications do so at their own risk and agree to fully indemnify Philips for any damages resulting from such improper use or sale.

**25 PURCHASE OF PHILIPS I<sup>2</sup>C COMPONENTS**

Purchase of Philips I<sup>2</sup>C components conveys a license under the Philips' I<sup>2</sup>C patent to use the components in the I<sup>2</sup>C system provided the system conforms to the I<sup>2</sup>C specification defined by Philips. This specification can be ordered using the code 9398 393 40011.

**26 BARE DIE DISCLAIMER**

All die are tested and are guaranteed to comply with all data sheet limits up to the point of wafer sawing for a period of ninety (90) days from the date of Philips' delivery. If there are data sheet limits not guaranteed, these will be separately indicated in the data sheet. There is no post wafer pack testing performed on individual die. Although the most modern processes are utilized for wafer sawing and die pick and place into wafer pack carriers, Philips Semiconductors has no control of third party procedures in the handling, packing or assembly of the die. Accordingly, Philips Semiconductors assumes no liability for device functionality or performance of the die or systems after handling, packing or assembly of the die. It is the responsibility of the customer to test and qualify their application in which the die is used.

65 × 102 pixels matrix LCD driver

PCF8548

---

**NOTES**

# Philips Semiconductors – a worldwide company

**Argentina:** see South America

**Australia:** 3 Figtree Drive, HOMEBUSH, NSW 2140,  
Tel. +61 2 9704 8141, Fax. +61 2 9704 8139

**Austria:** Computerstr. 6, A-1101 WIEN, P.O. Box 213,  
Tel. +43 1 60 101 1248, Fax. +43 1 60 101 1210

**Belarus:** Hotel Minsk Business Center, Bld. 3, r. 1211, Volodarski Str. 6,  
220050 MINSK, Tel. +375 172 20 0733, Fax. +375 172 20 0773

**Belgium:** see The Netherlands

**Brazil:** see South America

**Bulgaria:** Philips Bulgaria Ltd., Energoproject, 15th floor,  
51 James Bourchier Blvd., 1407 SOFIA,  
Tel. +359 2 68 9211, Fax. +359 2 68 9102

**Canada:** PHILIPS SEMICONDUCTORS/COMPONENTS,  
Tel. +1 800 234 7381, Fax. +1 800 943 0087

**China/Hong Kong:** 501 Hong Kong Industrial Technology Centre,  
72 Tat Chee Avenue, Kowloon Tong, HONG KONG,  
Tel. +852 2319 7888, Fax. +852 2319 7700

**Colombia:** see South America

**Czech Republic:** see Austria

**Denmark:** Sydhavnsgade 23, 1780 COPENHAGEN V,  
Tel. +45 33 29 3333, Fax. +45 33 29 3905

**Finland:** Sinikalliontie 3, FIN-02630 ESPOO,  
Tel. +358 9 615 800, Fax. +358 9 6158 0920

**France:** 51 Rue Carnot, BP317, 92156 SURESNES Cedex,  
Tel. +33 1 4099 6161, Fax. +33 1 4099 6427

**Germany:** Hammerbrookstraße 69, D-20097 HAMBURG,  
Tel. +49 40 2353 60, Fax. +49 40 2353 6300

**Hungary:** see Austria

**India:** Philips INDIA Ltd, Band Box Building, 2nd floor,  
254-D, Dr. Annie Besant Road, Worli, MUMBAI 400 025,  
Tel. +91 22 493 8541, Fax. +91 22 493 0966

**Indonesia:** PT Philips Development Corporation, Semiconductors Division,  
Gedung Philips, Jl. Buncit Raya Kav.99-100, JAKARTA 12510,  
Tel. +62 21 794 0040 ext. 2501, Fax. +62 21 794 0080

**Ireland:** Newstead, Clonskeagh, DUBLIN 14,  
Tel. +353 1 7640 000, Fax. +353 1 7640 200

**Israel:** RAPAC Electronics, 7 Kehilat Saloniki St, PO Box 18053,  
TEL AVIV 61180, Tel. +972 3 645 0444, Fax. +972 3 649 1007

**Italy:** PHILIPS SEMICONDUCTORS, Via Casati, 23 - 20052 MONZA (MI),  
Tel. +39 039 203 6838, Fax +39 039 203 6800

**Japan:** Philips Bldg 13-37, Kohnan 2-chome, Minato-ku,  
TOKYO 108-8507, Tel. +81 3 3740 5130, Fax. +81 3 3740 5057

**Korea:** Philips House, 260-199 Itaewon-dong, Yongsan-ku, SEOUL,  
Tel. +82 2 709 1412, Fax. +82 2 709 1415

**Malaysia:** No. 76 Jalan Universiti, 46200 PETALING JAYA, SELANGOR,  
Tel. +60 3 750 5214, Fax. +60 3 757 4880

**Mexico:** 5900 Gateway East, Suite 200, EL PASO, TEXAS 79905,  
Tel. +9-5 800 234 7381, Fax +9-5 800 943 0087

**Middle East:** see Italy

**Netherlands:** Postbus 90050, 5600 PB EINDHOVEN, Bldg. VB,  
Tel. +31 40 27 82785, Fax. +31 40 27 88399

**New Zealand:** 2 Wagener Place, C.P.O. Box 1041, AUCKLAND,  
Tel. +64 9 849 4160, Fax. +64 9 849 7811

**Norway:** Box 1, Manglerud 0612, OSLO,  
Tel. +47 22 74 8000, Fax. +47 22 74 8341

**Pakistan:** see Singapore

**Philippines:** Philips Semiconductors Philippines Inc.,  
106 Valero St. Salcedo Village, P.O. Box 2108 MCC, MAKATI,  
Metro MANILA, Tel. +63 2 816 6380, Fax. +63 2 817 3474

**Poland:** Ul. Lukiska 10, PL 04-123 WARSZAWA,  
Tel. +48 22 612 2831, Fax. +48 22 612 2327

**Portugal:** see Spain

**Romania:** see Italy

**Russia:** Philips Russia, Ul. Usatcheva 35A, 119048 MOSCOW,  
Tel. +7 095 755 6918, Fax. +7 095 755 6919

**Singapore:** Lorong 1, Toa Payoh, SINGAPORE 319762,  
Tel. +65 350 2538, Fax. +65 251 6500

**Slovakia:** see Austria

**Slovenia:** see Italy

**South Africa:** S.A. PHILIPS Pty Ltd., 195-215 Main Road Martindale,  
2092 JOHANNESBURG, P.O. Box 58088 Newville 2114,  
Tel. +27 11 471 5401, Fax. +27 11 471 5398

**South America:** Al. Vicente Pinzon, 173, 6th floor,  
04547-130 SÃO PAULO, SP, Brazil,  
Tel. +55 11 821 2333, Fax. +55 11 821 2382

**Spain:** Balmes 22, 08007 BARCELONA,  
Tel. +34 93 301 6312, Fax. +34 93 301 4107

**Sweden:** Kottbygatan 7, Akalla, S-16485 STOCKHOLM,  
Tel. +46 8 5985 2000, Fax. +46 8 5985 2745

**Switzerland:** Allmendstrasse 140, CH-8027 ZÜRICH,  
Tel. +41 1 488 2741 Fax. +41 1 488 3263

**Taiwan:** Philips Semiconductors, 6F, No. 96, Chien Kuo N. Rd., Sec. 1,  
TAIPEI, Taiwan Tel. +886 2 2134 2886, Fax. +886 2 2134 2874

**Thailand:** PHILIPS ELECTRONICS (THAILAND) Ltd.,  
209/2 Sanpavuth-Bangna Road Prakanong, BANGKOK 10260,  
Tel. +66 2 745 4090, Fax. +66 2 398 0793

**Turkey:** Yukari Dudullu, Org. San. Blg., 2.Cad. Nr. 28 81260 Umraniye,  
ISTANBUL, Tel. +90 216 522 1500, Fax. +90 216 522 1813

**Ukraine:** PHILIPS UKRAINE, 4 Patrice Lumumba str., Building B, Floor 7,  
252042 KIEV, Tel. +380 44 264 2776, Fax. +380 44 268 0461

**United Kingdom:** Philips Semiconductors Ltd., 276 Bath Road, Hayes,  
MIDDLESEX UB3 5BX, Tel. +44 208 730 5000, Fax. +44 208 754 8421

**United States:** 811 East Arques Avenue, SUNNYVALE, CA 94088-3409,  
Tel. +1 800 234 7381, Fax. +1 800 943 0087

**Uruguay:** see South America

**Vietnam:** see Singapore

**Yugoslavia:** PHILIPS, Trg N. Pasica 5/v, 11000 BEOGRAD,  
Tel. +381 11 62 5344, Fax. +381 11 63 5777

**For all other countries apply to:** Philips Semiconductors,  
International Marketing & Sales Communications, Building BE-p, P.O. Box 218,  
5600 MD EINDHOVEN, The Netherlands, Fax. +31 40 27 24825

**Internet:** <http://www.semiconductors.philips.com>

© Philips Electronics N.V. 1999

SCA67

All rights are reserved. Reproduction in whole or in part is prohibited without the prior written consent of the copyright owner.

The information presented in this document does not form part of any quotation or contract, is believed to be accurate and reliable and may be changed without notice. No liability will be accepted by the publisher for any consequence of its use. Publication thereof does not convey nor imply any license under patent- or other industrial or intellectual property rights.

Printed in The Netherlands

465006/02/pp40

Date of release: 1999 Aug 16

Document order number: 9397 750 05023

*Let's make things better.*

**Philips**  
Semiconductors



**PHILIPS**