

## Silicon Diffused Power Transistor

BUX87-1100

## GENERAL DESCRIPTION

High voltage, high speed, low capacitance npn power transistor in a SOT78 envelope intended for use in the dynamic focus circuit of televisions and monitors.

## QUICK REFERENCE DATA

SYMBOL	PARAMETER	CONDITIONS	TYP.	MAX.	UNIT
$V_{CESM}$	Collector-emitter voltage peak value	$V_{BE} = 0 \text{ V}$	-	1100	V
$V_{CEO}$	Collector-emitter voltage (open base)		-	700	V
$I_C$	Collector current (DC)		-	0.5	A
$I_{CM}$	Collector current peak value		-	1	A
$P_{tot}$	Total power dissipation	$T_{mb} \leq 25 \text{ }^\circ\text{C}$	-	46	W

## PINNING - TO220AB

PIN	DESCRIPTION
1	emitter
2	collector
3	base
tab	collector

## PIN CONFIGURATION

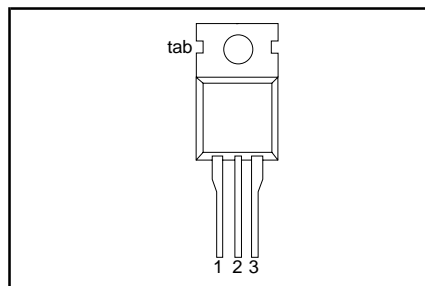

## SYMBOL

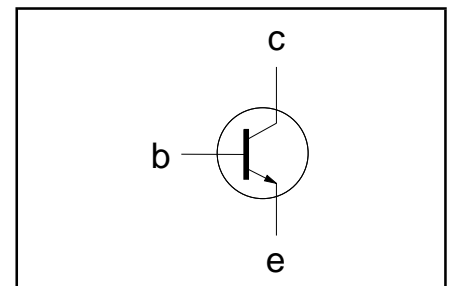

## LIMITING VALUES

Limiting values in accordance with the Absolute Maximum Rating System (IEC 134)

SYMBOL	PARAMETER	CONDITIONS	MIN.	MAX.	UNIT
$V_{CESM}$	Collector-emitter voltage peak value	$V_{BE} = 0 \text{ V}$	-	1100	V
$V_{CEO}$	Collector-emitter voltage (open base)		-	700	V
$I_C$	Collector current (DC)		-	0.5	A
$I_{CM}$	Collector current (peak value) $t_p = 2 \text{ ms}$		-	1	A
$I_B$	Base current (DC)		-	0.2	A
$I_{BM}$	Base current (peak value)		-	0.3	A
$-I_{BM}$	Reverse base current (peak value) <sup>1</sup>		-	0.3	A
$P_{tot}$	Total power dissipation	$T_{mb} \leq 25 \text{ }^\circ\text{C}$	-	46	W
$T_{stg}$	Storage temperature		-40	150	$^\circ\text{C}$
$T_j$	Junction temperature		-	150	$^\circ\text{C}$

## THERMAL RESISTANCES

SYMBOL	PARAMETER	CONDITIONS	TYP.	MAX.	UNIT
$R_{th\ j-mb}$	Junction to mounting base		-	2.7	K/W
$R_{th\ j-a}$	Junction to ambient	in free air	60	-	K/W

<sup>1</sup> Turn-off current.

## Silicon Diffused Power Transistor

BUX87-1100

**ELECTRICAL CHARACTERISTICS** $T_{mb} = 25\text{ }^{\circ}\text{C}$  unless otherwise specified

SYMBOL	PARAMETER	CONDITIONS	MIN.	TYP.	MAX.	UNIT
$I_{CES}$		$V_{BE} = 0\text{ V}; V_{CE} = V_{CESMmax}$	-	-	100	$\mu\text{A}$
$I_{CES}$		$V_{BE} = 0\text{ V}; V_{CE} = V_{CESMmax}$ $T_j = 125\text{ }^{\circ}\text{C}$	-	-	1.0	mA
$I_{EBO}$	Emitter cut-off current	$V_{EB} = 5\text{ V}; I_C = 0\text{ A}$	-	-	1	mA
$h_{FE}$	DC current gain	$I_C = 50\text{ mA}; V_{CE} = 5\text{ V}$	26	50	125	
$h_{FE}$	DC current gain	$I_C = 20\text{ mA}; V_{CE} = 5\text{ V}$	26	50	150	
$C_{ob}$	Output capacitance	$V_{CB} = 100\text{ V}; f = 1\text{ MHz}$	-	4.7	-	pF

Silicon Diffused Power Transistor

BUX87-1100

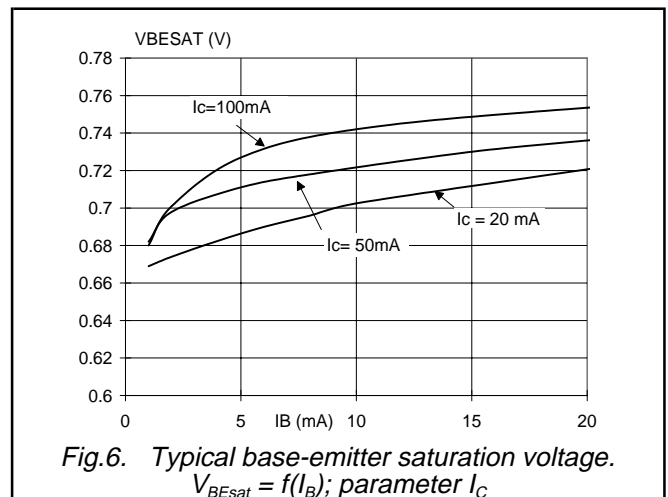
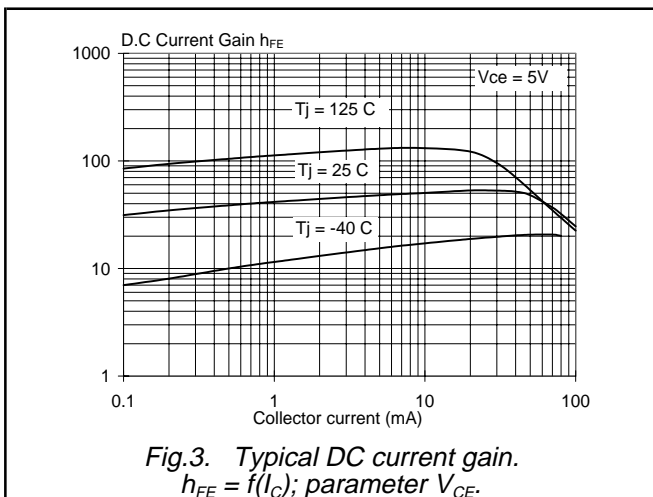
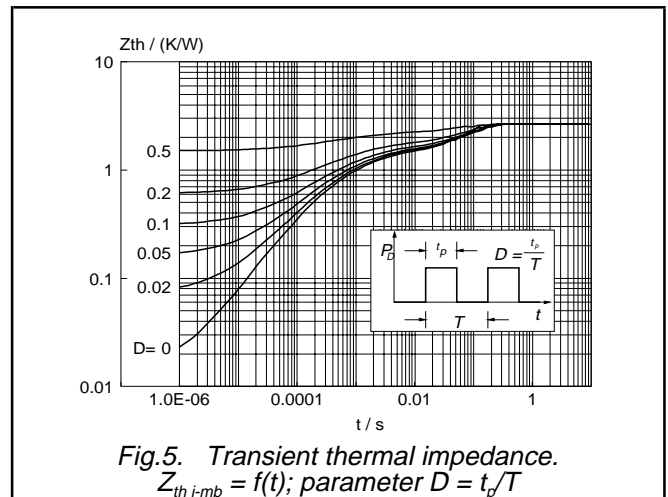
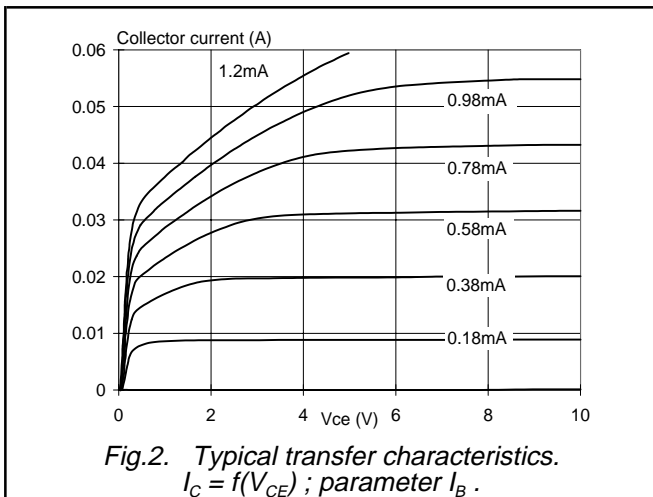
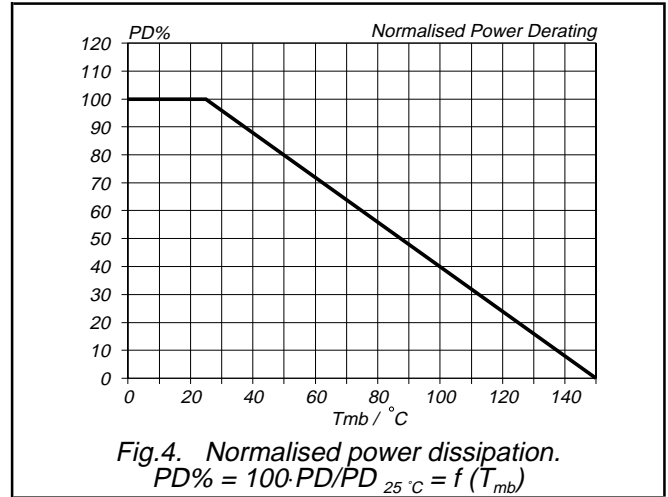
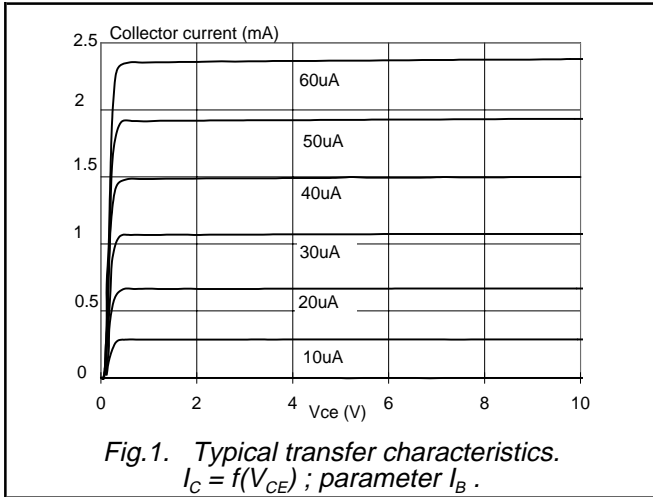

Silicon Diffused Power Transistor

BUX87-1100

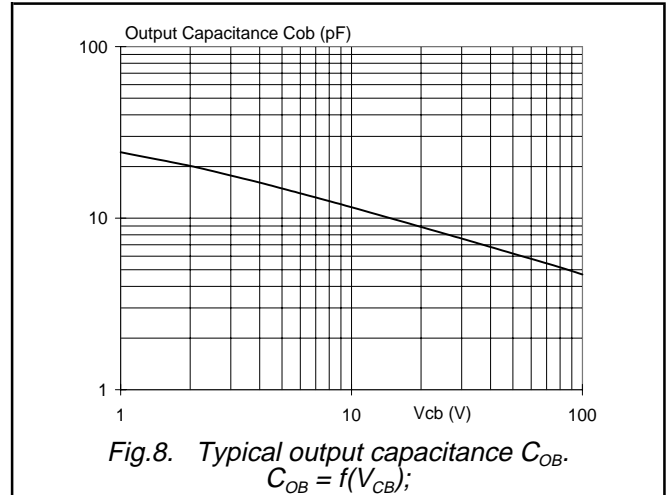
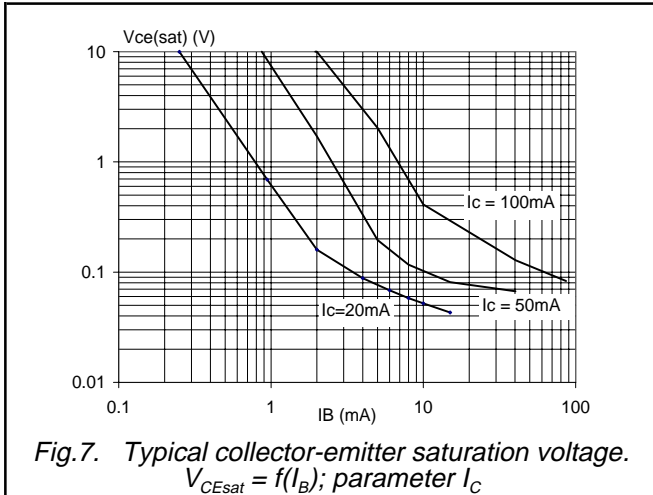

Silicon Diffused Power Transistor

BUX87-1100

**MECHANICAL DATA**

*Dimensions in mm*

*Net Mass: 2 g*

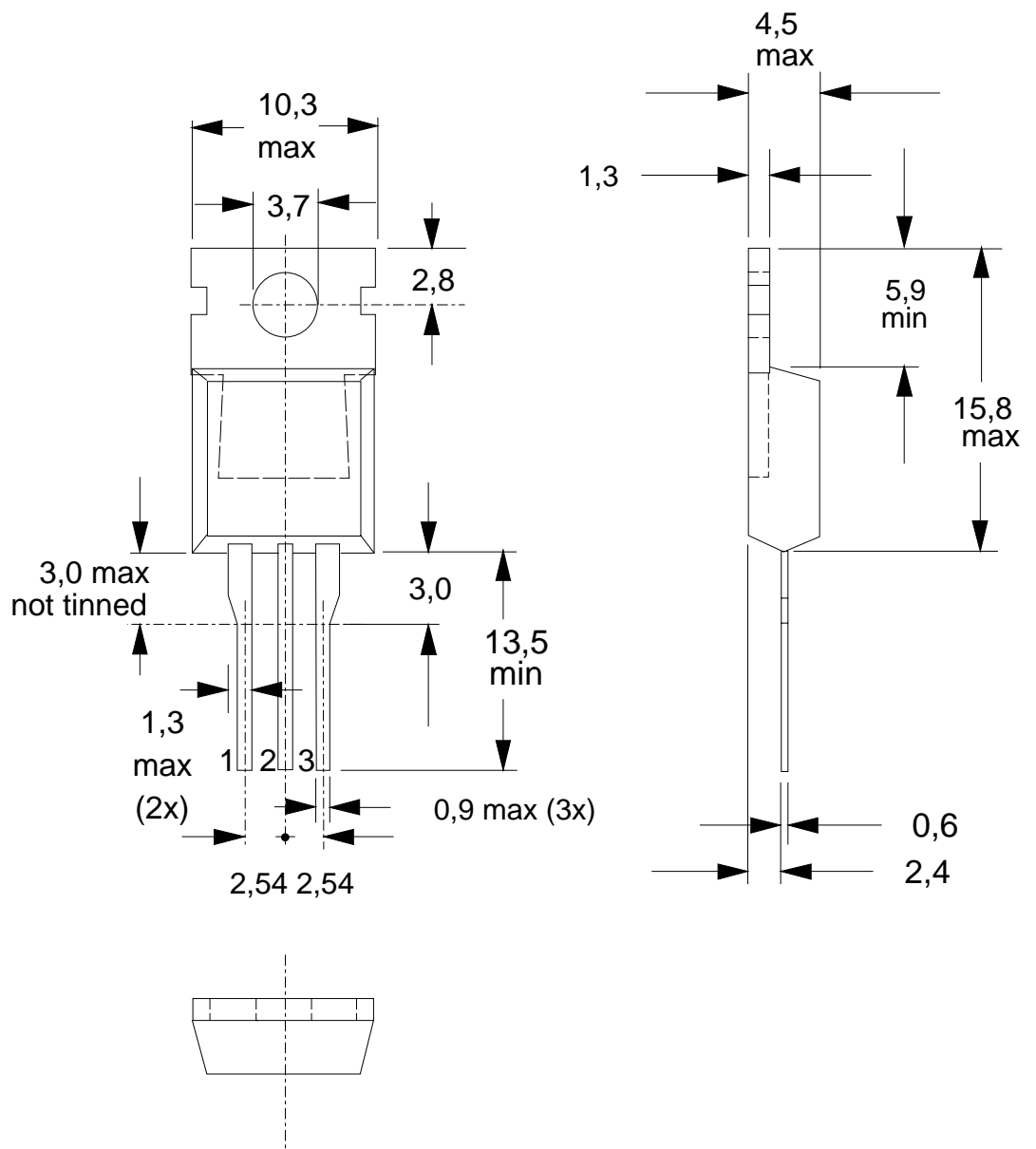

Fig.9. TO220AB; pin 2 connected to mounting base.

**Notes**

1. Refer to mounting instructions for TO220 envelopes.
2. Epoxy meets UL94 V0 at 1/8".

## Silicon Diffused Power Transistor

BUX87-1100

**DEFINITIONS**

<b>Data sheet status</b>	
Objective specification	This data sheet contains target or goal specifications for product development.
Preliminary specification	This data sheet contains preliminary data; supplementary data may be published later.
Product specification	This data sheet contains final product specifications.
<b>Limiting values</b>	
Limiting values are given in accordance with the Absolute Maximum Rating System (IEC 134). Stress above one or more of the limiting values may cause permanent damage to the device. These are stress ratings only and operation of the device at these or at any other conditions above those given in the Characteristics sections of this specification is not implied. Exposure to limiting values for extended periods may affect device reliability.	
<b>Application information</b>	
Where application information is given, it is advisory and does not form part of the specification.	
© Philips Electronics N.V. 1999	
All rights are reserved. Reproduction in whole or in part is prohibited without the prior written consent of the copyright owner.	
The information presented in this document does not form part of any quotation or contract, it is believed to be accurate and reliable and may be changed without notice. No liability will be accepted by the publisher for any consequence of its use. Publication thereof does not convey nor imply any license under patent or other industrial or intellectual property rights.	

**LIFE SUPPORT APPLICATIONS**

These products are not designed for use in life support appliances, devices or systems where malfunction of these products can be reasonably expected to result in personal injury. Philips customers using or selling these products for use in such applications do so at their own risk and agree to fully indemnify Philips for any damages resulting from such improper use or sale.