

# Damper diode fast, high-voltage

**BY479X-1700**

## FEATURES

- Low forward volt drop
- Low Forward recovery voltage
- Fast switching
- Soft recovery characteristic
- High thermal cycling performance
- Isolated mounting tab

## SYMBOL

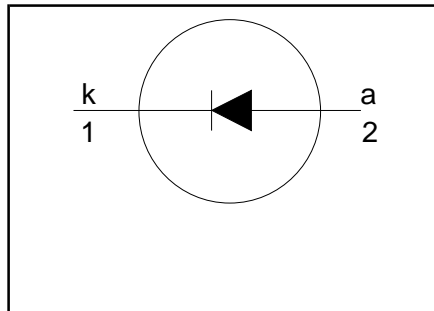

## QUICK REFERENCE DATA

|                             |
|-----------------------------|
| $V_R = 1700\text{ V}$       |
| $V_F \leq 1.2\text{ V}$     |
| $V_{fr} \leq 19\text{ V}$   |
| $I_{FWM} = 10\text{ A}$     |
| $I_{FRM} \leq 100\text{ A}$ |
| $t_{fr} \leq 300\text{ ns}$ |

## GENERAL DESCRIPTION

Glass-passivated double diffused rectifier diode featuring fast forward recovery and low forward recovery voltage. The device is intended for use in multi-sync monitor deflection circuits up to 64kHz. The device is designed to withstand transient reverse voltages up to 1700V.

The BY479X series is supplied in the conventional leaded SOD113 package.

## PINNING

| PIN | DESCRIPTION |
|-----|-------------|
| 1   | cathode     |
| 2   | anode       |
| tab | isolated    |

## SOD113

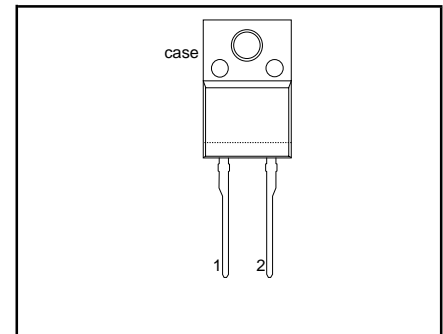

## LIMITING VALUES

Limiting values in accordance with the Absolute Maximum System (IEC 134).

| SYMBOL    | PARAMETER   | CONDITIONS   | MIN. | MAX. | UNIT             |
|-----------|---|--|------|------|------------------|
| $V_{RSM}$ | Peak non-repetitive reverse voltage during flash-over of picture tube |  | -    | 1700 | V                |
| $V_{RRM}$ | Peak repetitive reverse voltage                                       | $t = 3.5\ \mu\text{s}; f = 64\text{kHz}$   | -    | 1700 | V                |
| $V_{RWM}$ | Crest working reverse voltage   |  | -    | 1300 | V                |
| $I_{FWM}$ | Peak working forward current <sup>1</sup>                             | $f = 64\text{kHz}; T_{hs} \leq 126\text{ }^\circ\text{C}$  | -    | 10   | A                |
| $I_{FRM}$ | Peak repetitive forward current                                       | $t = 100\ \mu\text{s}$   | -    | 100  | A                |
| $I_{FSM}$ | Peak non-repetitive forward current                                   | $t = 10\text{ ms}$<br>$t = 8.3\text{ ms}$<br>sinusoidal; $T_j = 150\text{ }^\circ\text{C}$ prior to surge; with reapplied $V_{RWM(max)}$ | -    | 100  | A                |
| $T_{stg}$ | Storage temperature   |  | -40  | 150  | $^\circ\text{C}$ |
| $T_j$     | Operating junction temperature  |  | -    | 150  | $^\circ\text{C}$ |

<sup>1</sup> Including worst case forward recovery losses, see fig:5.

## Damper diode fast, high-voltage

BY479X-1700

### ISOLATION LIMITING VALUE & CHARACTERISTIC

$T_{hs} = 25\text{ °C}$  unless otherwise specified

| SYMBOL     | PARAMETER   | CONDITIONS   | MIN. | TYP. | MAX. | UNIT |
|------------|---|--|------|------|------|------|
| $V_{isol}$ | R.M.S. isolation voltage from both terminals to external heatsink | $f = 50\text{-}60\text{ Hz}$ ; sinusoidal waveform;<br>$R.H. \leq 65\%$ ; clean and dustfree | -    |      | 2500 | V    |
| $C_{isol}$ | Capacitance from both terminals to external heatsink              | $f = 1\text{ MHz}$   | -    | 10   | -    | pF   |

### THERMAL RESISTANCES

| SYMBOL                | PARAMETER                               | CONDITIONS                               | MIN. | TYP. | MAX. | UNIT |
|-----------------------|---|--|------|------|------|------|
| $R_{th\ j\text{-}hs}$ | Thermal resistance junction to heatsink | with heatsink compound                   | -    | -    | 4.8  | K/W  |
| $R_{th\ j\text{-}a}$  | Thermal resistance junction to ambient  | without heatsink compound<br>in free air | -    | 55   | 5.9  | K/W  |

### STATIC CHARACTERISTICS

$T_j = 25\text{ °C}$  unless otherwise stated

| SYMBOL | PARAMETER       | CONDITIONS   | MIN. | TYP. | MAX. | UNIT |
|--------|-----------------|--|------|------|------|------|
| $V_F$  | Forward voltage | $I_F = 6.5\text{ A}$   | -    | 0.95 | 1.3  | V    |
| $I_R$  | Reverse current | $I_F = 6.5\text{ A}$ ; $T_j = 125\text{ °C}$<br>$V_R = V_{RWMmax}$<br>$V_R = V_{RWMmax}$ ; $T_j = 125\text{ °C}$ | -    | 0.85 | 1.2  | V    |
|        |                 |  | -    | -    | 0.25 | mA   |
|        |                 |  | -    | -    | 1.0  | mA   |

### DYNAMIC CHARACTERISTICS

$T_j = 25\text{ °C}$  unless otherwise stated

| SYMBOL   | PARAMETER                | CONDITIONS   | MIN. | TYP. | MAX. | UNIT          |
|----------|--------------------------|--|------|------|------|---------------|
| $V_{fr}$ | Forward recovery voltage | $I_F = 6.5\text{ A}$ ; $di_F/dt = 50\text{ A}/\mu\text{s}$                         | -    | 12   | 19   | V             |
| $t_{fr}$ | Forward recovery time    | $I_F = 6.5\text{ A}$ ; $di_F/dt = 50\text{ A}/\mu\text{s}$ ; $V_F = 5\text{ V}$    | -    | 200  | 300  | ns            |
|          |                          | $I_F = 6.5\text{ A}$ ; $di_F/dt = 50\text{ A}/\mu\text{s}$ ; $V_F = 2\text{ V}$    | -    | 400  | -    | ns            |
| $t_{rr}$ | Reverse recovery time    | $I_F = 1\text{ A}$ ; $-di_F/dt = 50\text{ A}/\mu\text{s}$ ; $V_R \geq 30\text{ V}$ | -    | 250  | 350  | ns            |
| $Q_s$    | Reverse recovery charge  | $I_F = 2\text{ A}$ ; $-di_F/dt = 20\text{ A}/\mu\text{s}$ ; $V_R \geq 30\text{ V}$ | -    | 2.0  | 3.0  | $\mu\text{C}$ |

Damper diode  
fast, high-voltage

BY479X-1700

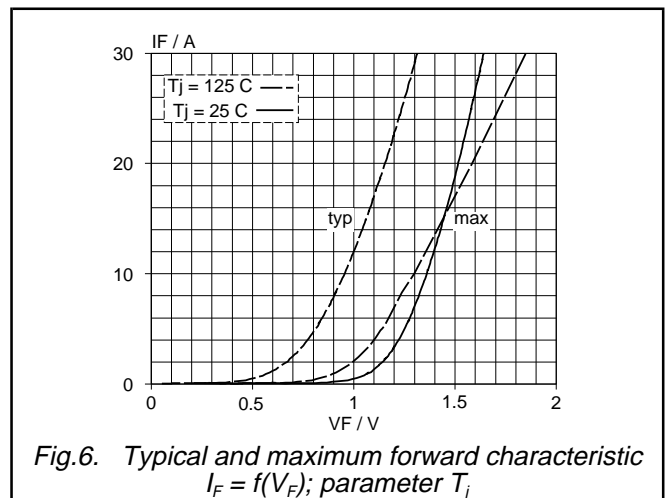
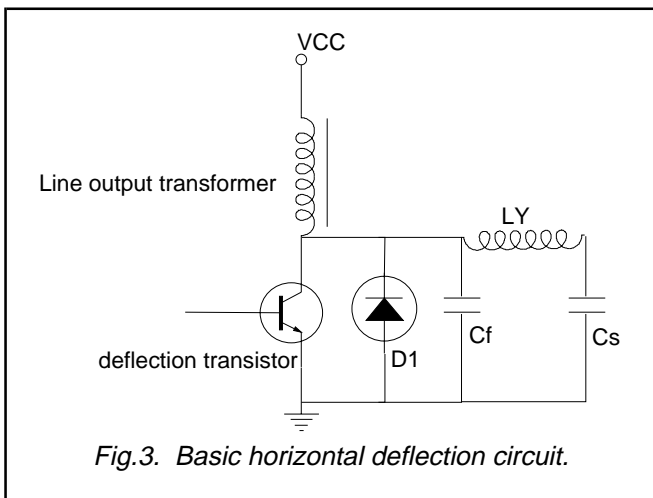
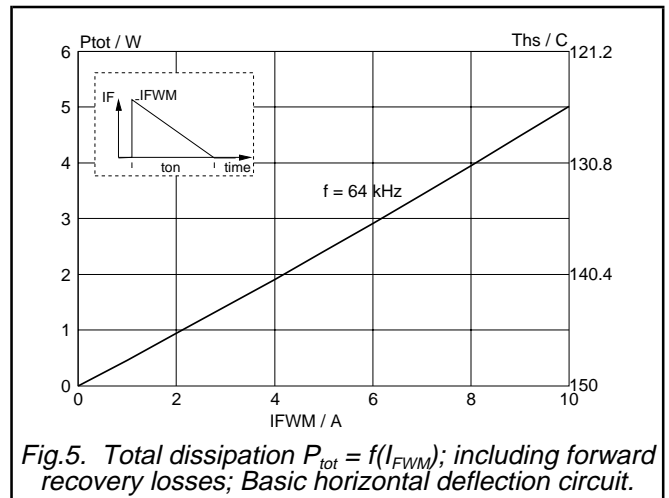
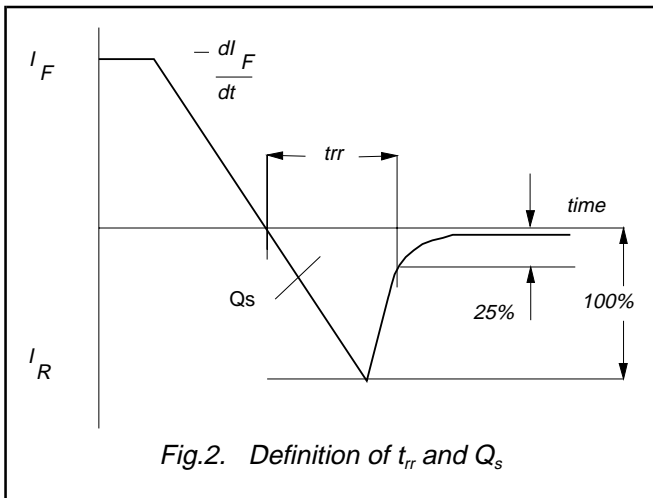
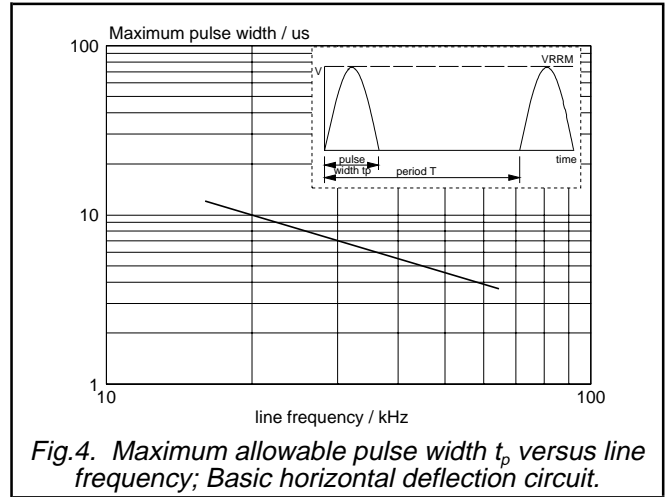
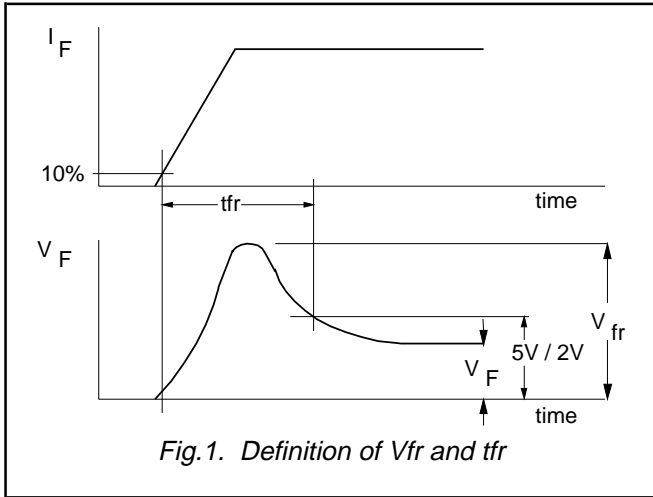

Damper diode  
fast, high-voltage

BY479X-1700

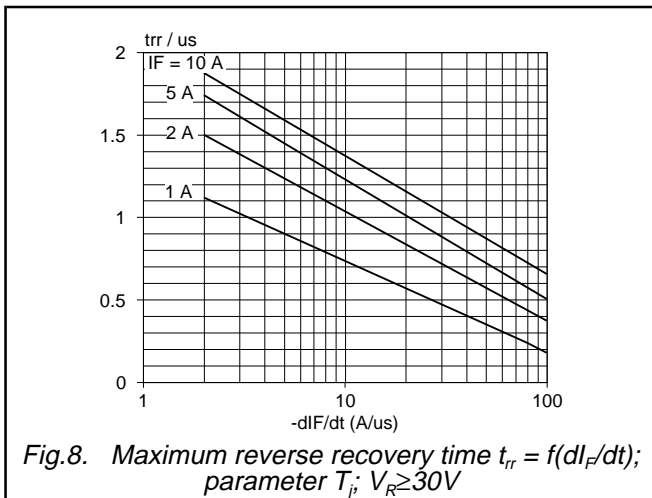
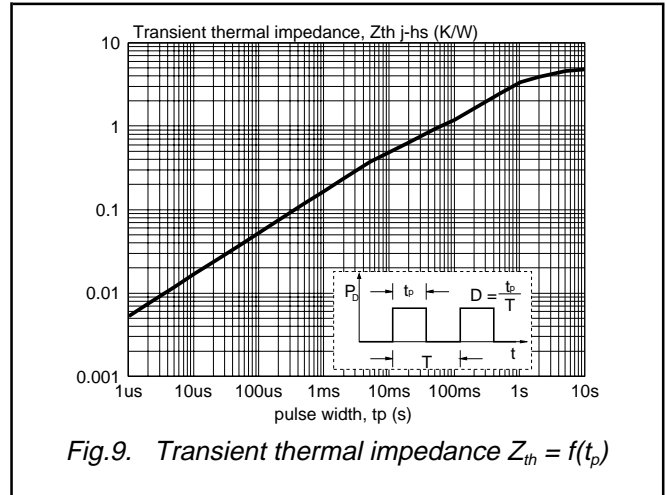
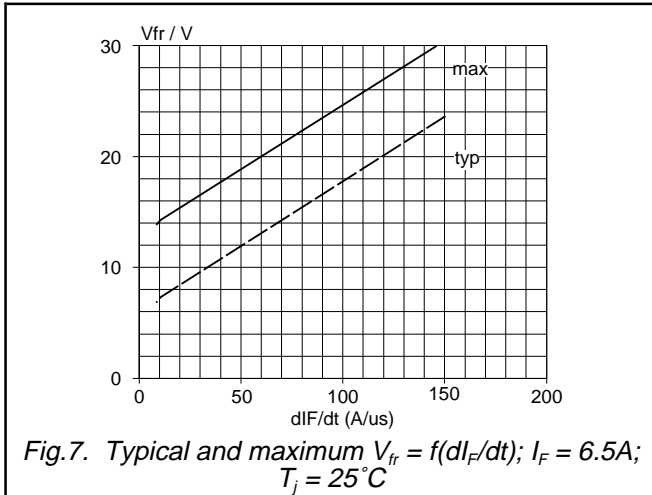

Damper diode  
fast, high-voltage

BY479X-1700

**MECHANICAL DATA**

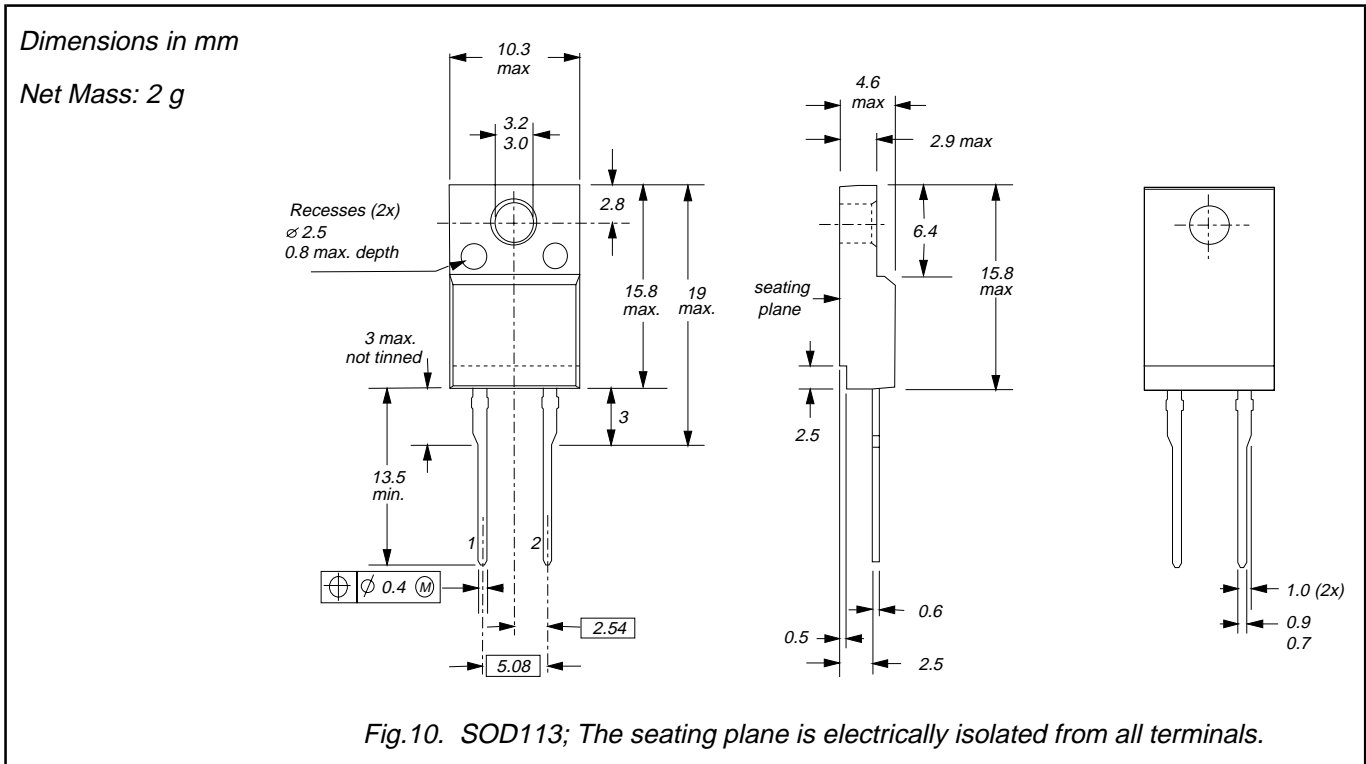

**Notes**

1. Refer to mounting instructions for F-pack envelopes.
2. Epoxy meets UL94 V0 at 1/8".

---

**Damper diode  
fast, high-voltage**

---

BY479X-1700

**DEFINITIONS**

|  |   |
|--|---|
| <b>Data sheet status</b>   |   |
| Objective specification  | This data sheet contains target or goal specifications for product development.       |
| Preliminary specification  | This data sheet contains preliminary data; supplementary data may be published later. |
| Product specification  | This data sheet contains final product specifications.                                |
| <b>Limiting values</b>   |   |
| Limiting values are given in accordance with the Absolute Maximum Rating System (IEC 134). Stress above one or more of the limiting values may cause permanent damage to the device. These are stress ratings only and operation of the device at these or at any other conditions above those given in the Characteristics sections of this specification is not implied. Exposure to limiting values for extended periods may affect device reliability. |   |
| <b>Application information</b>   |   |
| Where application information is given, it is advisory and does not form part of the specification.  |   |
| <b>© Philips Electronics N.V. 1998</b>   |   |
| All rights are reserved. Reproduction in whole or in part is prohibited without the prior written consent of the copyright owner.  |   |
| The information presented in this document does not form part of any quotation or contract, it is believed to be accurate and reliable and may be changed without notice. No liability will be accepted by the publisher for any consequence of its use. Publication thereof does not convey nor imply any license under patent or other industrial or intellectual property rights.   |   |

**LIFE SUPPORT APPLICATIONS**

These products are not designed for use in life support appliances, devices or systems where malfunction of these products can be reasonably expected to result in personal injury. Philips customers using or selling these products for use in such applications do so at their own risk and agree to fully indemnify Philips for any damages resulting from such improper use or sale.