

# Damper diode ultra fast, high-voltage

**BY559X-1500U**

## FEATURES

- Low forward volt drop
- Low forward recovery voltage
- Ultra Fast switching
- Soft recovery characteristic
- High thermal cycling performance
- Low thermal resistance

## SYMBOL

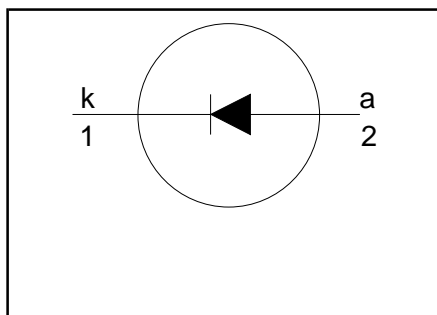

## QUICK REFERENCE DATA

$V_R = 1500\text{ V}$
$V_F \leq 1.5\text{ V}$
$V_{fr} \leq 8\text{ V}$
$t_{rr} \leq 130\text{ ns}$
$I_{FWM} = 10\text{ A}$
$I_{FSM} \leq 160\text{ A}$

## GENERAL DESCRIPTION

A double diffused rectifier diode in a plastic envelope, featuring ultra fast forward and reverse recovery and low forward voltage. The device is intended for use as a damper diode in horizontal deflection circuits of large screen monitors and workstations in applications up to 150kHz.

The BY559 series is supplied in the conventional leaded SOD59 and SOD113 packages.

## PINNING

PIN	DESCRIPTION
1	cathode
2	anode
case	isolated

## SOD113

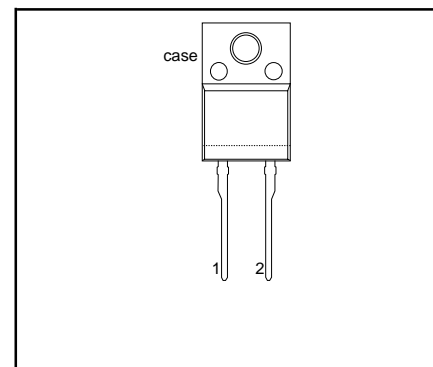

## LIMITING VALUES

Limiting values in accordance with the Absolute Maximum System (IEC 134).

SYMBOL	PARAMETER	CONDITIONS	MIN.	MAX.	UNIT
$V_{RRM}$	Peak repetitive reverse voltage		-	1500	V
$V_{RWM}$	Crest working reverse voltage		-	1300	V
$I_{FWM}$	Peak working forward current	$f = 120\text{ kHz};$	-	10	A
$I_{FRM}$	Peak repetitive forward current	$t = 100\text{ }\mu\text{s}$	-	150	A
$I_{FSM}$	Peak non-repetitive forward current	$t = 10\text{ ms}$ sinusoidal; $T_j = 150\text{ }^\circ\text{C}$ prior to surge; with reapplied $V_{RWM(max)}$	-	160	A
$T_{stg}$	Storage temperature		-40	150	$^\circ\text{C}$
$T_j$	Operating junction temperature		-	150	$^\circ\text{C}$

## ISOLATION LIMITING VALUE & CHARACTERISTIC

$T_{hs} = 25\text{ }^\circ\text{C}$  unless otherwise specified

SYMBOL	PARAMETER	CONDITIONS	MIN.	TYP.	MAX.	UNIT
$V_{isol}$	R.M.S. isolation voltage from both terminals to external heatsink	$f = 50\text{-}60\text{ Hz};$ sinusoidal waveform; R.H. $\leq 65\%$ ; clean and dustfree	-		2500	V
$C_{isol}$	Capacitance from both terminals to external heatsink	$f = 1\text{ MHz}$	-	10	-	pF

## Damper diode ultra fast, high-voltage

BY559X-1500U

### THERMAL RESISTANCES

SYMBOL	PARAMETER	CONDITIONS	MIN.	TYP.	MAX.	UNIT
$R_{th\ j-hs}$	Thermal resistance junction to heatsink	with heatsink compound	-	-	4.8	K/W
$R_{th\ j-a}$	Thermal resistance junction to ambient	in free air	-	55	-	K/W

### STATIC CHARACTERISTICS

 $T_j = 25\text{ °C}$  unless otherwise stated

SYMBOL	PARAMETER	CONDITIONS	MIN.	TYP.	MAX.	UNIT
$V_F$	Forward voltage	$I_F = 6.5\text{ A}$	-	1.7	2.05	V
$I_R$	Reverse current	$I_F = 6.5\text{ A}; T_j = 125\text{ °C}$	-	1.2	1.5	V
		$V_R = V_{RWMmax}$	-	-	0.5	mA
		$V_R = V_{RWMmax}; T_j = 125\text{ °C}$	-	-	2.0	mA

### DYNAMIC CHARACTERISTICS

 $T_j = 25\text{ °C}$  unless otherwise stated

SYMBOL	PARAMETER	CONDITIONS	MIN.	TYP.	MAX.	UNIT
$V_{fr}$	Forward recovery voltage	$I_F = 6.5\text{ A}; di_F/dt = 50\text{ A}/\mu\text{s}$	-	6	8	V
$t_{fr}$	Forward recovery time	$I_F = 6.5\text{ A}; di_F/dt = 50\text{ A}/\mu\text{s}; V_F = 5\text{ V}$	-	130	180	ns
$t_{rr}$	Reverse recovery time	$I_F = 1\text{ A}; -di_F/dt = 50\text{ A}/\mu\text{s}; V_R \geq 30\text{ V}$	-	100	130	ns
$Q_s$	Reverse recovery charge	$I_F = 2\text{ A}; -di_F/dt = 20\text{ A}/\mu\text{s}; V_R \geq 30\text{ V}$	-	0.2	0.3	$\mu\text{C}$

Damper diode  
ultra fast, high-voltage

BY559X-1500U

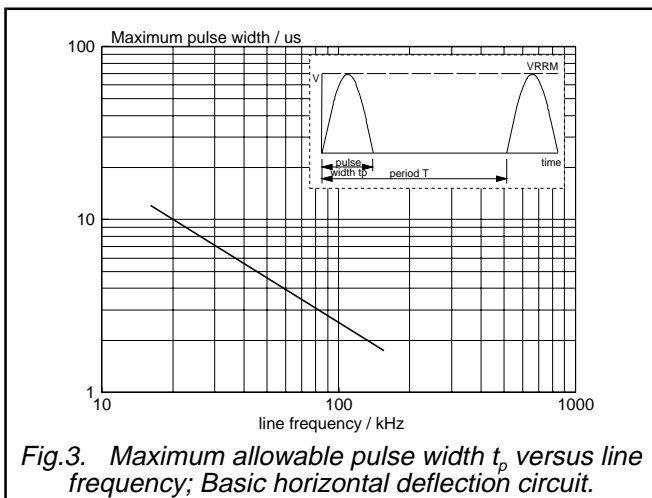
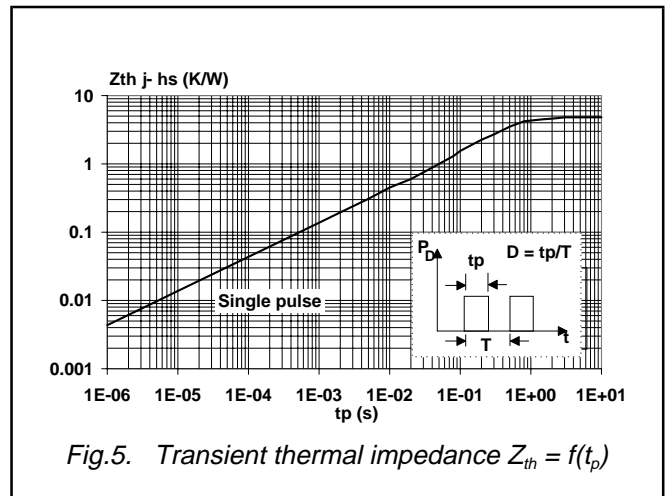
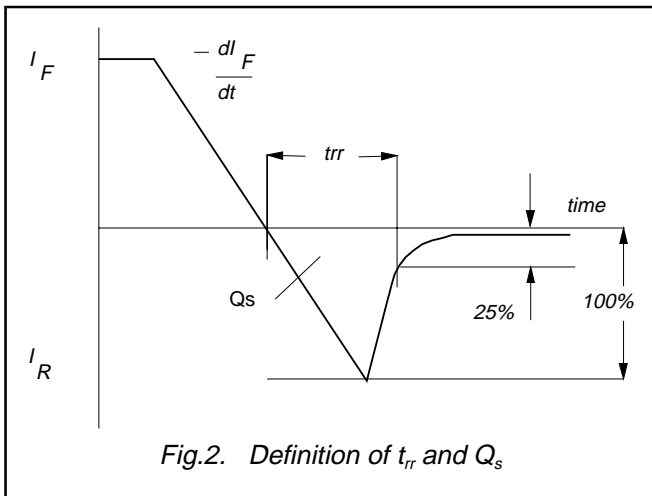
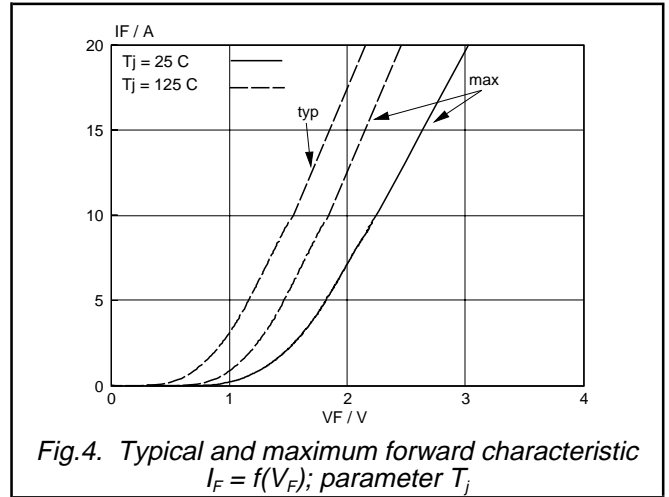
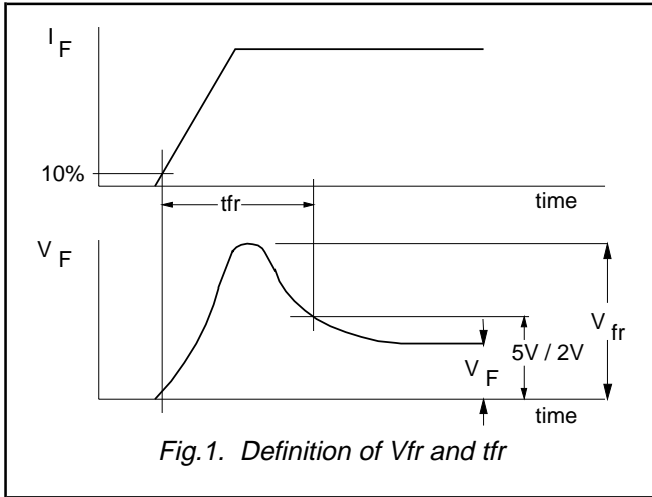

Damper diode  
ultra fast, high-voltage

BY559X-1500U

MECHANICAL DATA

Dimensions in mm

Net Mass: 2 g

Plastic single-ended package; isolated heatsink mounted;  
1 mounting hole; 2-leads TO-220 'full pack'

SOD113

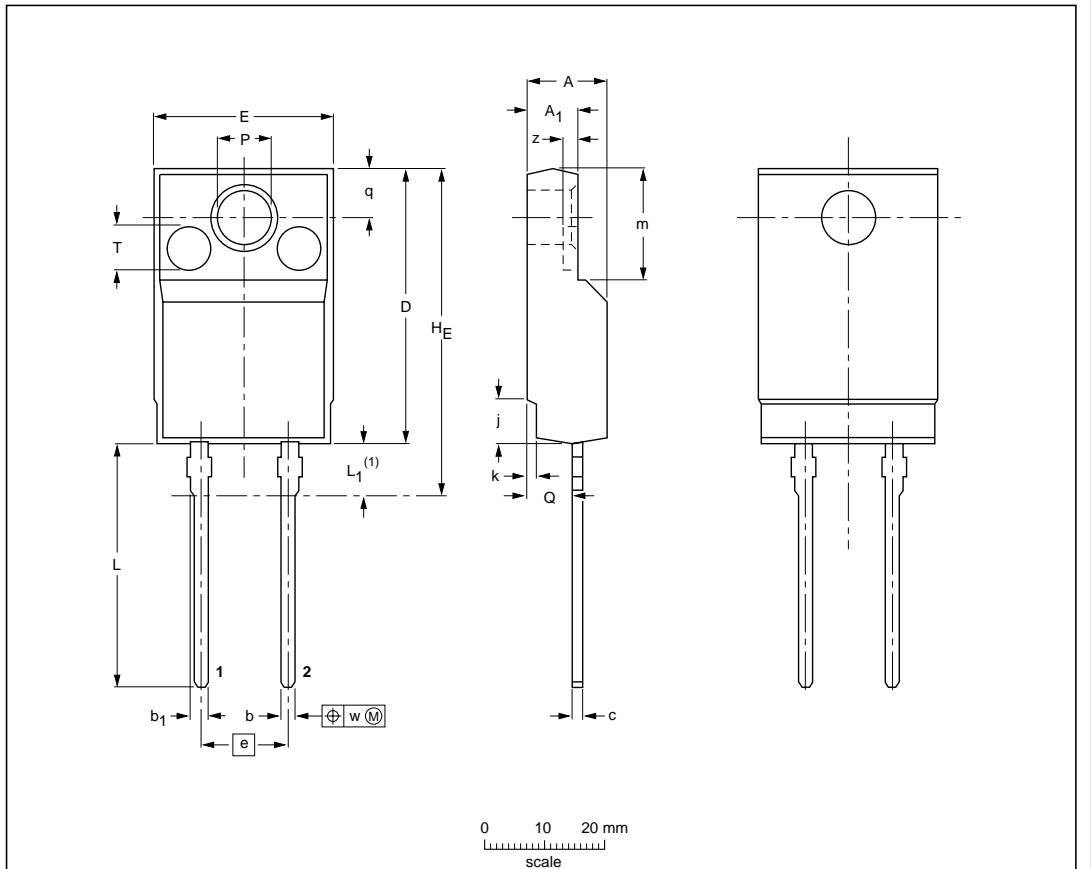

DIMENSIONS (mm are the original dimensions)

UNIT	A	A <sub>1</sub>	b	b <sub>1</sub>	c	D	E	e	H <sub>E</sub> max.	j	k	L	L <sub>1</sub> <sup>(1)</sup>	m	P	Q	q	T	w	z <sup>(2)</sup>
mm	4.6 4.0	2.9 2.5	0.9 0.7	1.1 0.9	0.7 0.4	15.8 15.2	10.3 9.7	5.08	19.0	2.7 2.3	0.6 0.4	14.4 13.5	3.3 2.8	6.5 6.3	3.2 3.0	2.6 2.3	2.6	2.55	0.4	0.8

Notes

1. Terminals are uncontrolled within zone L<sub>1</sub>.
2. z is depth of T.

OUTLINE VERSION	REFERENCES				EUROPEAN PROJECTION	ISSUE DATE
	IEC	JEDEC	EIAJ			
SOD113		2-lead TO-220				97-06-11

Fig.6. SOD113; The seating plane is electrically isolated from all terminals.

Notes

1. Refer to mounting instructions for F-pack envelopes.
2. Epoxy meets UL94 V0 at 1/8".

## Damper diode ultra fast, high-voltage

BY559X-1500U

### DEFINITIONS

<b>Data sheet status</b>	
Objective specification	This data sheet contains target or goal specifications for product development.
Preliminary specification	This data sheet contains preliminary data; supplementary data may be published later.
Product specification	This data sheet contains final product specifications.
<b>Limiting values</b>	
Limiting values are given in accordance with the Absolute Maximum Rating System (IEC 134). Stress above one or more of the limiting values may cause permanent damage to the device. These are stress ratings only and operation of the device at these or at any other conditions above those given in the Characteristics sections of this specification is not implied. Exposure to limiting values for extended periods may affect device reliability.	
<b>Application information</b>	
Where application information is given, it is advisory and does not form part of the specification.	
© Philips Electronics N.V. 1999	
All rights are reserved. Reproduction in whole or in part is prohibited without the prior written consent of the copyright owner.	
The information presented in this document does not form part of any quotation or contract, it is believed to be accurate and reliable and may be changed without notice. No liability will be accepted by the publisher for any consequence of its use. Publication thereof does not convey nor imply any license under patent or other industrial or intellectual property rights.	

### LIFE SUPPORT APPLICATIONS

These products are not designed for use in life support appliances, devices or systems where malfunction of these products can be reasonably expected to result in personal injury. Philips customers using or selling these products for use in such applications do so at their own risk and agree to fully indemnify Philips for any damages resulting from such improper use or sale.