

# DATA SHEET

**BFG31**

**PNP 5 GHz wideband transistor**

Product specification  
Supersedes data of November 1992  
File under Discrete Semiconductors, SC14

1995 Sep 12

## PNP 5 GHz wideband transistor

BFG31

## FEATURES

- High output voltage capability
- High gain bandwidth product
- Good thermal stability
- Gold metallization ensures excellent reliability.

## PINNING

PIN	DESCRIPTION
1	emitter
2	base
3	emitter
4	collector

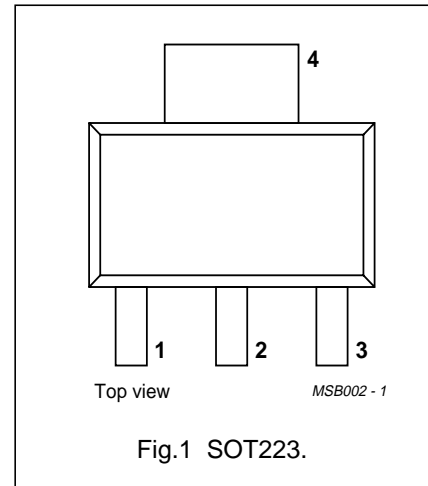

## DESCRIPTION

PNP planar epitaxial transistor mounted in a plastic SOT223 envelope.

It is intended for wideband amplifier applications.

NPN complement is the BFG97.

## QUICK REFERENCE DATA

SYMBOL	PARAMETER	CONDITIONS	MIN.	TYP.	MAX.	UNIT
$V_{CEO}$	collector-emitter voltage	open base	–	–	–15	V
$I_C$	DC collector current		–	–	–100	mA
$P_{tot}$	total power dissipation	up to $T_s = 135\text{ °C}$ ; note 1	–	–	1	W
$h_{FE}$	DC current gain	$I_C = -70\text{ mA}$ ; $V_{CE} = -10\text{ V}$ ; $T_{amb} = 25\text{ °C}$	25	–	–	
$f_T$	transition frequency	$I_C = -70\text{ mA}$ ; $V_{CE} = -10\text{ V}$ ; $f = 500\text{ MHz}$ ; $T_{amb} = 25\text{ °C}$	–	5.0	–	GHz
$G_{UM}$	maximum unilateral power gain	$I_C = -70\text{ mA}$ ; $V_{CE} = -10\text{ V}$ ; $f = 800\text{ MHz}$ ; $T_{amb} = 25\text{ °C}$	–	12	–	dB
$V_o$	output voltage	$I_C = -100\text{ mA}$ ; $V_{CE} = -10\text{ V}$ ; $R_L = 75\text{ }\Omega$ ; $T_{amb} = 25\text{ °C}$	–	600	–	mV

## LIMITING VALUES

In accordance with the Absolute Maximum System (IEC 134).

SYMBOL	PARAMETER	CONDITIONS	MIN.	MAX.	UNIT
$V_{CBO}$	collector-base voltage	open emitter	–	–20	V
$V_{CEO}$	collector-emitter voltage	open base	–	–15	V
$V_{EBO}$	emitter-base voltage	open collector	–	–3	V
$I_C$	DC collector current		–	–100	mA
$P_{tot}$	total power dissipation	up to $T_s = 135\text{ °C}$ ; note 1	–	1	W
$T_{stg}$	storage temperature		–65	150	°C
$T_j$	junction temperature		–	175	°C

## Note

1.  $T_s$  is the temperature at the soldering point of the collector tab.

## PNP 5 GHz wideband transistor

BFG31

## THERMAL CHARACTERISTICS

SYMBOL	PARAMETER	CONDITIONS	THERMAL RESISTANCE
$R_{th\ j-s}$	thermal resistance from junction to soldering point	up to $T_s = 135\text{ °C}$ ; note 1	40 K/W

## Note

- $T_s$  is the temperature at the soldering point of the collector tab.

## CHARACTERISTICS

$T_j = 25\text{ °C}$  unless otherwise specified.

SYMBOL	PARAMETER	CONDITIONS	MIN.	TYP.	MAX.	UNIT
$V_{(BR)CBO}$	collector-base breakdown voltage	open emitter; $I_C = -10\text{ mA}$	-20	–	–	V
$V_{(BR)CEO}$	collector-emitter breakdown voltage	open base; $I_C = -10\text{ mA}$	-18	–	–	V
$V_{(BR)EBO}$	emitter-base breakdown voltage	open collector; $I_E = -0.1\text{ mA}$	-3	–	–	V
$I_{CBO}$	collector cut-off current	$I_E = 0$ ; $V_{CB} = -10\text{ V}$	–	–	-1	$\mu\text{A}$
$h_{FE}$	DC current gain	$I_C = -70\text{ mA}$ ; $V_{CE} = -10\text{ V}$ ; $T_{amb} = 25\text{ °C}$	25	–	–	
$C_{cb}$	collector-base capacitance	$I_C = 0$ ; $V_{CB} = -10\text{ V}$ ; $f = 1\text{ MHz}$ ;	–	1.8	–	pF
$C_{eb}$	emitter-base capacitance	$I_C = 0$ ; $V_{EB} = -10\text{ V}$ ; $f = 1\text{ MHz}$	–	5	–	pF
$C_{re}$	feedback capacitance	$I_C = 0$ ; $V_{CE} = -10\text{ V}$ ; $f = 1\text{ MHz}$ ; $T_{amb} = 25\text{ °C}$	–	1.6	–	pF
$f_T$	transition frequency	$I_C = -70\text{ mA}$ ; $V_{CE} = -10\text{ V}$ ; $f = 500\text{ MHz}$ ; $T_{amb} = 25\text{ °C}$	–	5	–	GHz
$G_{UM}$	maximum unilateral power gain; note 1	$I_C = -70\text{ mA}$ ; $V_{CE} = -10\text{ V}$ ; $f = 500\text{ MHz}$ ; $T_{amb} = 25\text{ °C}$	–	16	–	dB
		$I_C = -70\text{ mA}$ ; $V_{CE} = -10\text{ V}$ ; $f = 800\text{ MHz}$ ; $T_{amb} = 25\text{ °C}$	–	12	–	dB
$V_o$	output voltage	note 2	–	600	–	mV
$V_o$	output voltage	note 3	–	550	–	mV

## Notes

- $G_{UM}$  is the maximum unilateral power gain, assuming  $S_{12}$  is zero and  $G_{UM} = 10 \log \frac{|S_{21}|^2}{(1 - |S_{11}|^2)(1 - |S_{22}|^2)}$  dB.
- $d_{im} = -60\text{ dB}$ ;  $I_C = -70\text{ mA}$ ;  $V_{CE} = -10\text{ V}$ ;  $R_L = 75\ \Omega$ ;  $T_{amb} = 25\text{ °C}$ ;  
 $V_p = V_o$  at  $d_{im} = -60\text{ dB}$ ;  $f_p = 850.25\text{ MHz}$ ;  
 $V_q = V_o - 6\text{ dB}$ ;  $f_q = 858.25\text{ MHz}$ ;  
 $V_r = V_o - 6\text{ dB}$ ;  $f_r = 860.25\text{ MHz}$ ;  
measured at  $f_{(p+q-r)} = 848.25\text{ MHz}$ .
- $d_{im} = -60\text{ dB}$  (DIN 45004B);  $I_C = -70\text{ mA}$ ;  $V_{CE} = -10\text{ V}$ ;  $R_L = 75\ \Omega$ ;  $T_{amb} = 25\text{ °C}$ ;  
 $V_p = V_o =$  at  $d_{im} = -60\text{ dB}$ ;  $f_p = 445.25\text{ MHz}$ ;  
 $V_q = V_o - 6\text{ dB}$ ;  $f_q = 453.25\text{ MHz}$ ;  
 $V_r = V_o - 6\text{ dB}$ ;  $f_r = 455.25\text{ MHz}$ ;  
measured at  $f_{(p+q-r)} = 443.25\text{ MHz}$ .

PNP 5 GHz wideband transistor

BFG31

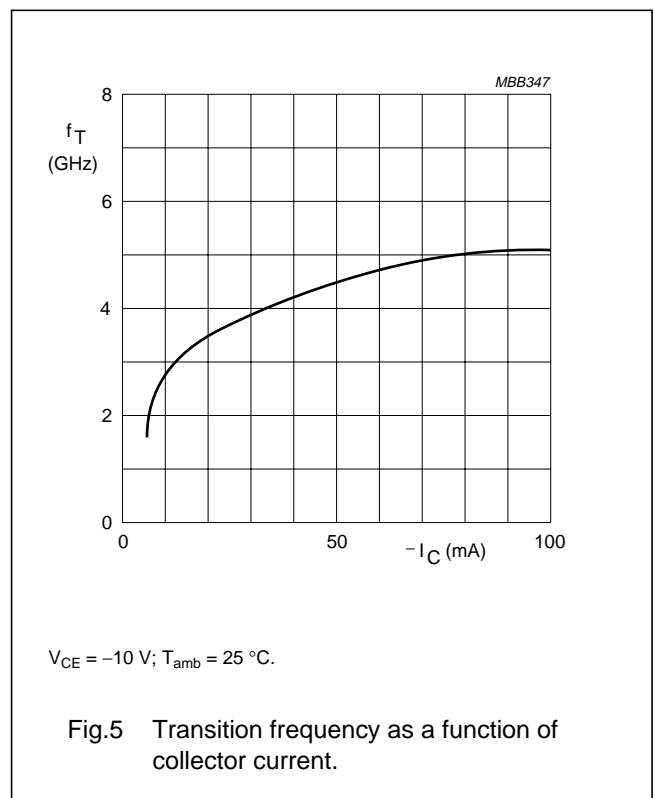
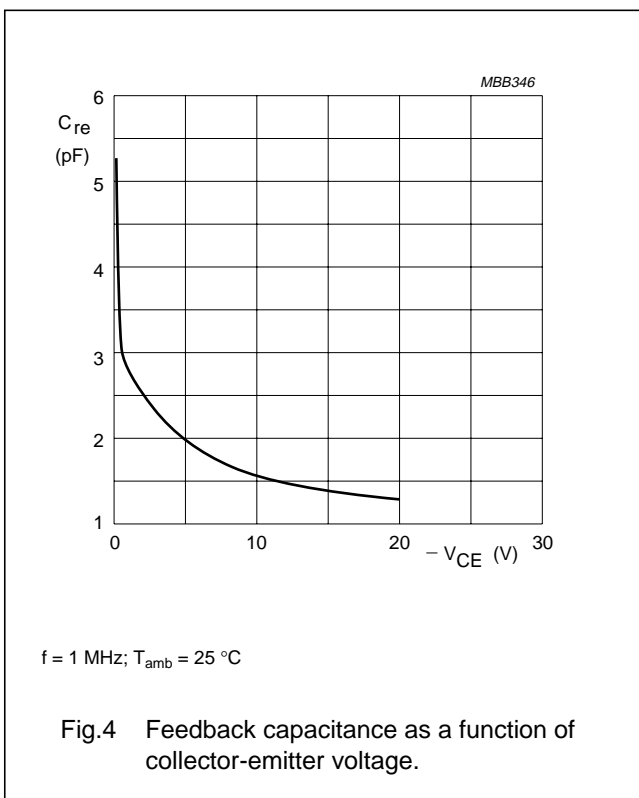
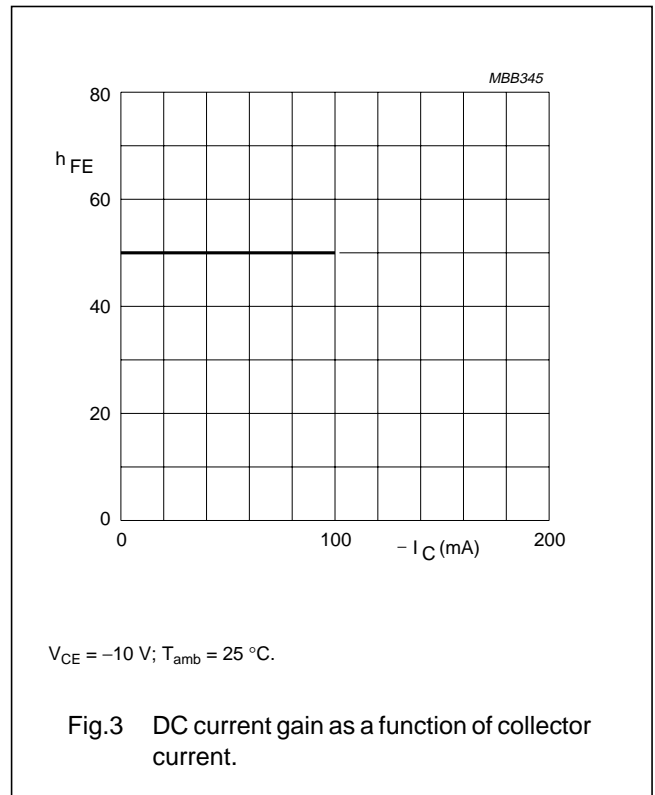
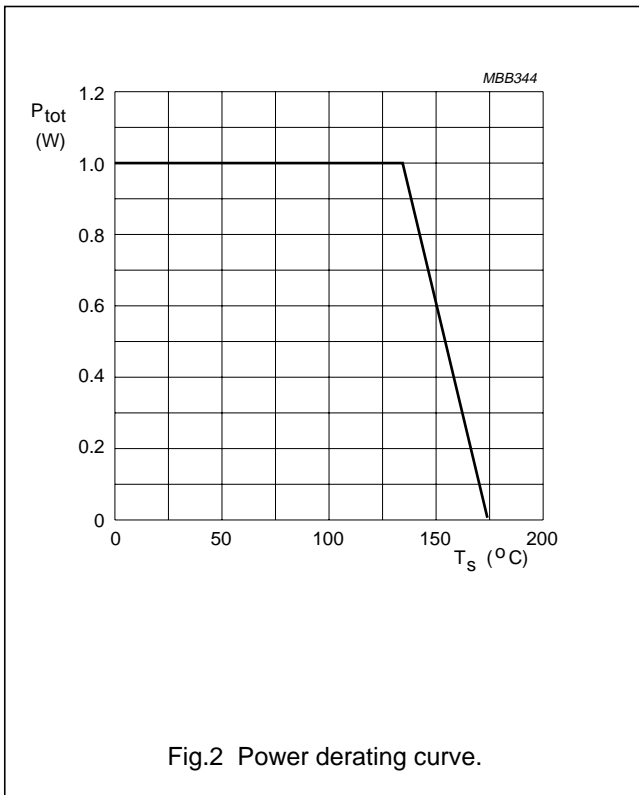

PNP 5 GHz wideband transistor

BFG31

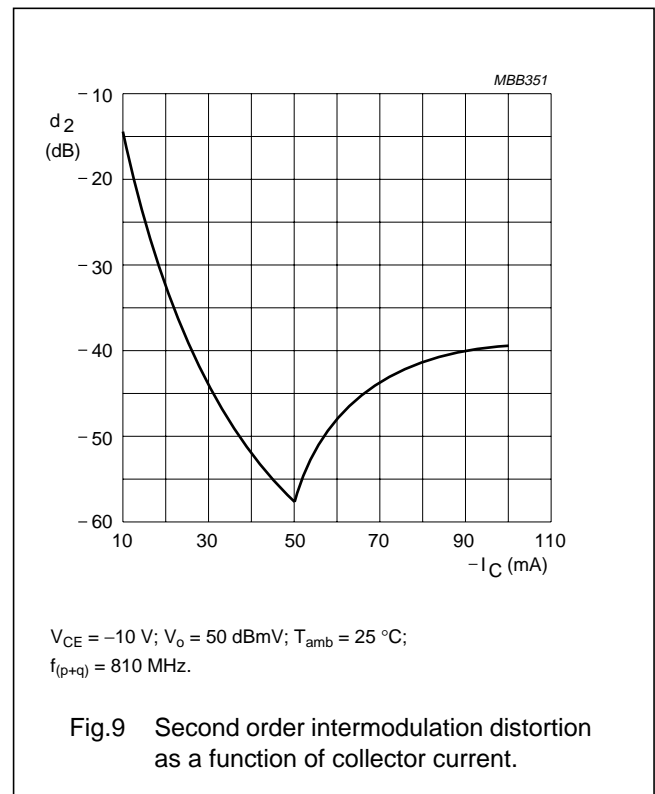
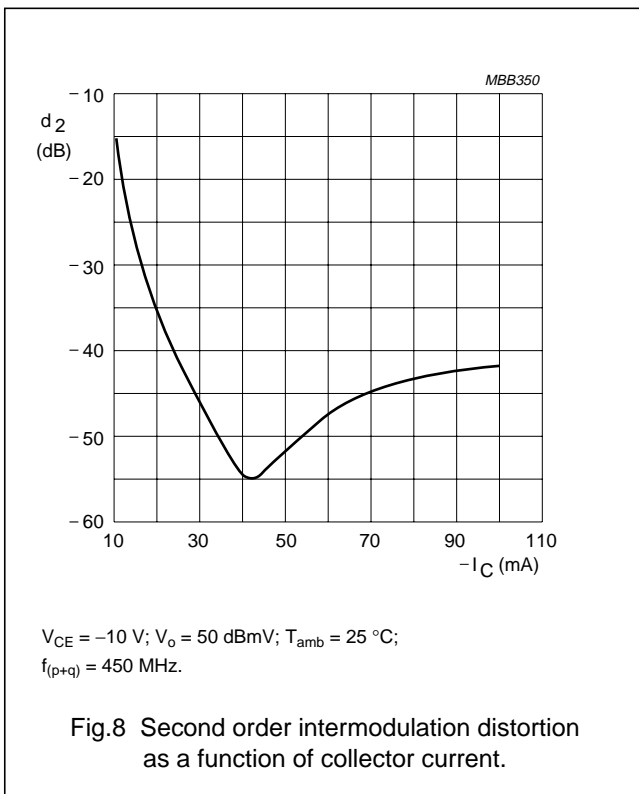
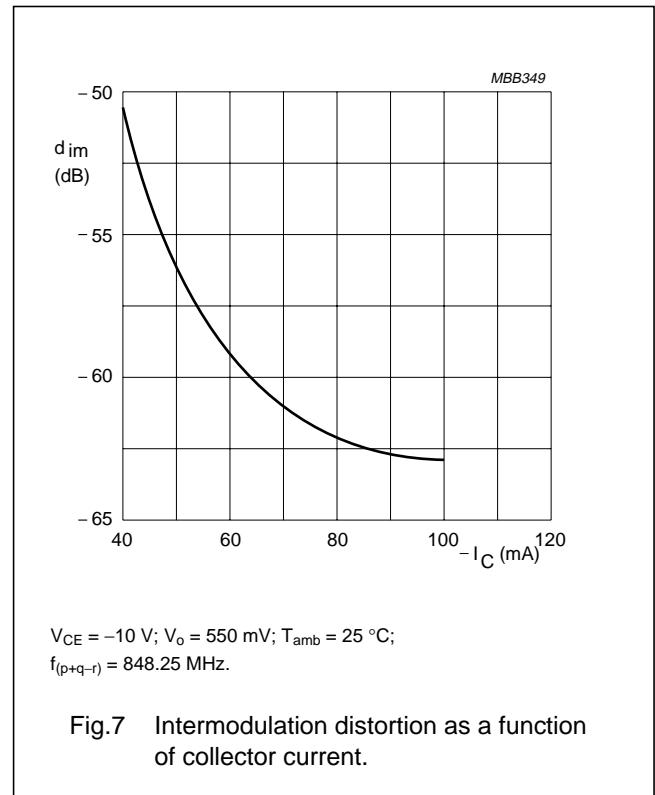
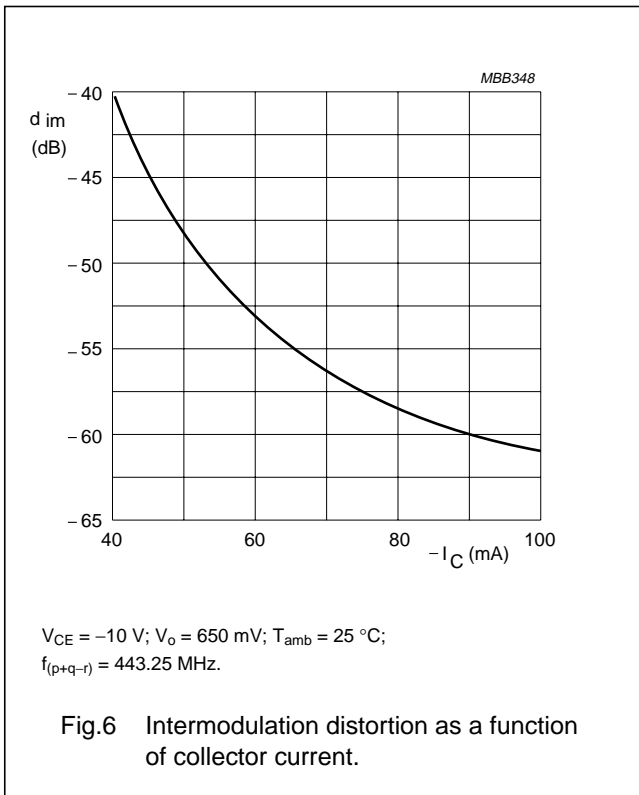



## PNP 5 GHz wideband transistor

BFG31

**DEFINITIONS**

<b>Data sheet status</b>	
Objective specification	This data sheet contains target or goal specifications for product development.
Preliminary specification	This data sheet contains preliminary data; supplementary data may be published later.
Product specification	This data sheet contains final product specifications.
<b>Limiting values</b>	
Limiting values given are in accordance with the Absolute Maximum Rating System (IEC 134). Stress above one or more of the limiting values may cause permanent damage to the device. These are stress ratings only and operation of the device at these or at any other conditions above those given in the Characteristics sections of the specification is not implied. Exposure to limiting values for extended periods may affect device reliability.	
<b>Application information</b>	
Where application information is given, it is advisory and does not form part of the specification.	

**LIFE SUPPORT APPLICATIONS**

These products are not designed for use in life support appliances, devices, or systems where malfunction of these products can reasonably be expected to result in personal injury. Philips customers using or selling these products for use in such applications do so at their own risk and agree to fully indemnify Philips for any damages resulting from such improper use or sale.