

N-channel TrenchMOS™ transistor

PHX3055E

FEATURES

- 'Trench' technology
- Low on-state resistance
- Fast switching
- Isolated mounting tab

SYMBOL



QUICK REFERENCE DATA

$V_{DSS} = 55 \text{ V}$
$I_D = 9 \text{ A}$
$R_{DS(ON)} \leq 150 \text{ m}\Omega (V_{GS} = 10 \text{ V})$

GENERAL DESCRIPTION

N-channel enhancement mode, field-effect power transistor in a plastic envelope with an electrically isolated mounting tab. The device uses 'trench' technology to achieve low on-state resistance.

Applications:-

- d.c. to d.c. converters
- switched mode power supplies

The PHX3055E is supplied in the SOT186A (isolated TO220AB) conventional leaded package.

PINNING

PIN	DESCRIPTION
1	gate
2	drain
3	source
tab	isolated

SOT186A

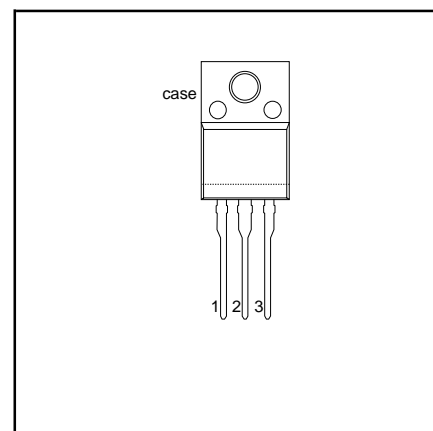

LIMITING VALUES

Limiting values in accordance with the Absolute Maximum System (IEC 134)

SYMBOL	PARAMETER	CONDITIONS	MIN.	MAX.	UNIT
V_{DSS}	Drain-source voltage	$T_j = 25 \text{ }^\circ\text{C}$ to $150 \text{ }^\circ\text{C}$	-	55	V
V_{DGR}	Drain-gate voltage	$T_j = 25 \text{ }^\circ\text{C}$ to $150 \text{ }^\circ\text{C}$; $R_{GS} = 20 \text{ k}\Omega$	-	55	V
V_{GS}	Gate-source voltage		-	± 20	V
I_D	Continuous drain current	$T_{hs} = 25 \text{ }^\circ\text{C}$	-	9	A
		$T_{hs} = 100 \text{ }^\circ\text{C}$	-	5.6	A
I_{DM}	Pulsed drain current	$T_{hs} = 25 \text{ }^\circ\text{C}$	-	36	A
P_D	Total power dissipation	$T_{hs} = 25 \text{ }^\circ\text{C}$	-	21	W
T_j, T_{stg}	Operating junction and storage temperature		- 55	150	$^\circ\text{C}$

ISOLATION LIMITING VALUE & CHARACTERISTIC

$T_{hs} = 25 \text{ }^\circ\text{C}$ unless otherwise specified

SYMBOL	PARAMETER	CONDITIONS	MIN.	TYP.	MAX.	UNIT
V_{isol}	R.M.S. isolation voltage from all three terminals to external heatsink	$f = 50\text{-}60 \text{ Hz}$; sinusoidal waveform; R.H. $\leq 65\%$; clean and dustfree	-		2500	V
C_{isol}	Capacitance from T2 to external heatsink	$f = 1 \text{ MHz}$	-	10	-	pF

N-channel TrenchMOS™ transistor

PHX3055E

AVALANCHE ENERGY LIMITING VALUES

Limiting values in accordance with the Absolute Maximum System (IEC 134)

SYMBOL	PARAMETER	CONDITIONS	MIN.	MAX.	UNIT
E_{AS}	Non-repetitive avalanche energy	Unclamped inductive load, $I_{AS} = 3.3$ A; $t_p = 220$ μ s; T_j prior to avalanche = 25 °C; $V_{DD} \leq 25$ V; $R_{GS} = 50$ Ω ; $V_{GS} = 10$ V; refer to fig:15	-	25	mJ
I_{AS}	Peak non-repetitive avalanche current		-	9	A

THERMAL RESISTANCES

SYMBOL	PARAMETER	CONDITIONS	TYP.	MAX.	UNIT
$R_{th\ j-hs}$	Thermal resistance junction to heatsink		-	6	K/W
$R_{th\ j-a}$	Thermal resistance junction to ambient		55	-	K/W

ELECTRICAL CHARACTERISTICS $T_j = 25$ °C unless otherwise specified

SYMBOL	PARAMETER	CONDITIONS	MIN.	TYP.	MAX.	UNIT
$V_{(BR)DSS}$	Drain-source breakdown voltage	$V_{GS} = 0$ V; $I_D = 0.25$ mA; $T_j = -55$ °C	55 50	- -	- -	V V
$V_{GS(TO)}$	Gate threshold voltage	$V_{DS} = V_{GS}$; $I_D = 1$ mA $T_j = 150$ °C $T_j = -55$ °C	2.0 1.1 -	3.0 - 6	4.0 - 6	V V V
$R_{DS(ON)}$	Drain-source on-state resistance	$V_{GS} = 10$ V; $I_D = 5.5$ A $T_j = 150$ °C	- -	120 210	150 263	m Ω m Ω
g_{fs}	Forward transconductance	$V_{DS} = 25$ V; $I_D = 5.5$ A	1.5	3.2	-	S
I_{GSS}	Gate source leakage current	$V_{GS} = \pm 10$ V; $V_{DS} = 0$ V	-	10	100	nA
I_{DSS}	Zero gate voltage drain current	$V_{DS} = 55$ V; $V_{GS} = 0$ V; $T_j = 150$ °C	- -	0.05 -	10 100	μ A μ A
$Q_{g(tot)}$	Total gate charge	$I_D = 10$ A; $V_{DD} = 44$ V; $V_{GS} = 10$ V	-	5.8	-	nC
Q_{gs}	Gate-source charge		-	1.5	-	nC
Q_{gd}	Gate-drain (Miller) charge		-	3.2	-	nC
t_{don}	Turn-on delay time	$V_{DD} = 30$ V; $R_D = 2.7$ Ω ; $R_G = 5.6$ Ω ; $V_{GS} = 10$ V Resistive load	-	3	10	ns
t_r	Turn-on rise time		-	26	35	ns
t_{doff}	Turn-off delay time		-	8	15	ns
t_f	Turn-off fall time		-	10	20	ns
L_d	Internal drain inductance	Measured from drain lead to centre of die	-	4.5	-	nH
L_s	Internal source inductance	Measured from source lead to source bond pad	-	7.5	-	nH
C_{iss}	Input capacitance	$V_{GS} = 0$ V; $V_{DS} = 25$ V; $f = 1$ MHz	-	190	250	pF
C_{oss}	Output capacitance		-	55	80	pF
C_{rss}	Feedback capacitance		-	40	50	pF

N-channel TrenchMOS™ transistor

PHX3055E

REVERSE DIODE LIMITING VALUES AND CHARACTERISTICS $T_j = 25^\circ\text{C}$ unless otherwise specified

SYMBOL	PARAMETER	CONDITIONS	MIN.	TYP.	MAX.	UNIT
I_S	Continuous source current (body diode)		-	-	9	A
I_{SM}	Pulsed source current (body diode)		-	-	36	A
V_{SD}	Diode forward voltage	$I_F = 10\text{ A}; V_{GS} = 0\text{ V}$	-	1.1	1.5	V
t_{rr}	Reverse recovery time	$I_F = 10\text{ A}; -di_F/dt = 100\text{ A}/\mu\text{s};$ $V_{GS} = 0\text{ V}; V_R = 30\text{ V}$	-	32	-	ns
Q_{rr}	Reverse recovery charge		-	50	-	nC

N-channel TrenchMOS™ transistor

PHX3055E

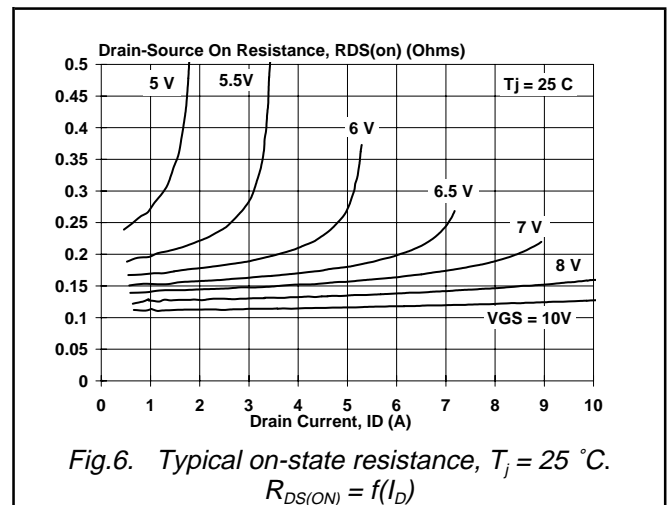
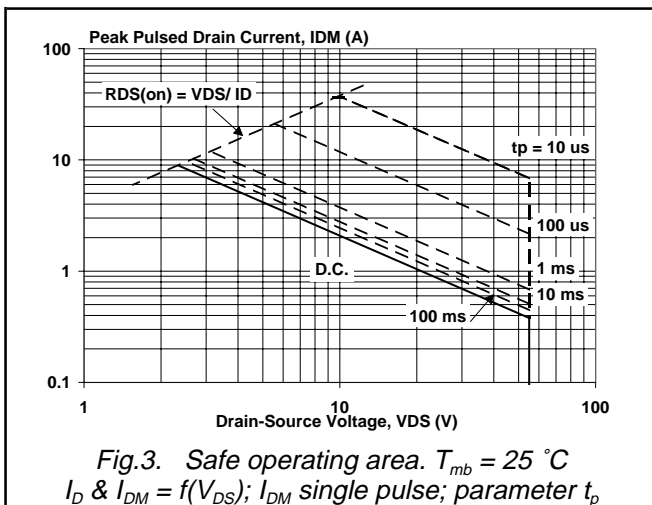
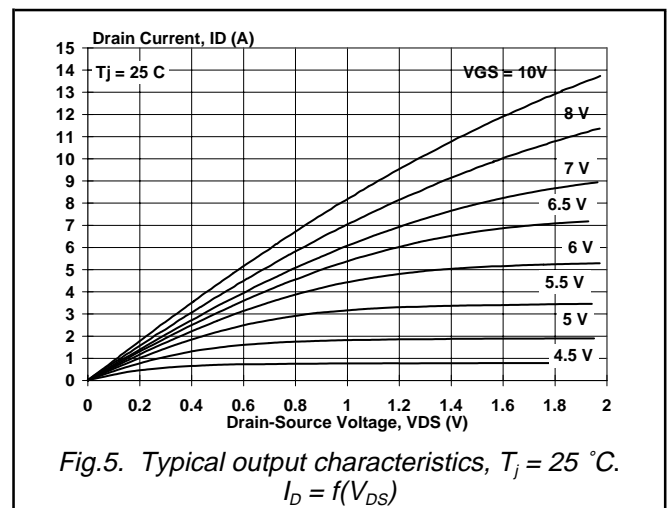
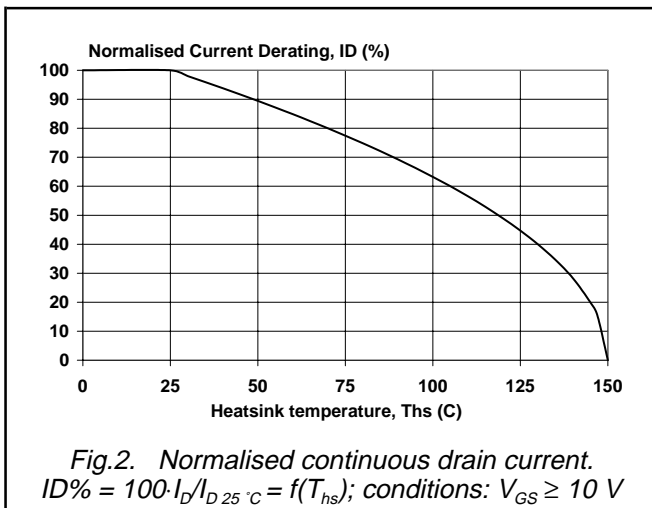
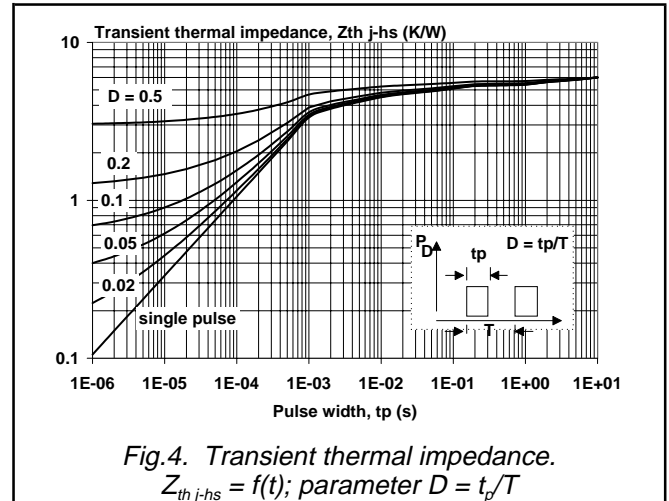
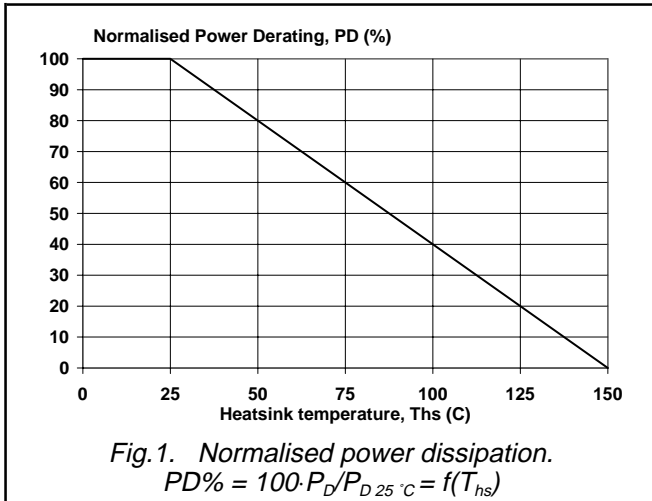

N-channel TrenchMOS™ transistor

PHX3055E

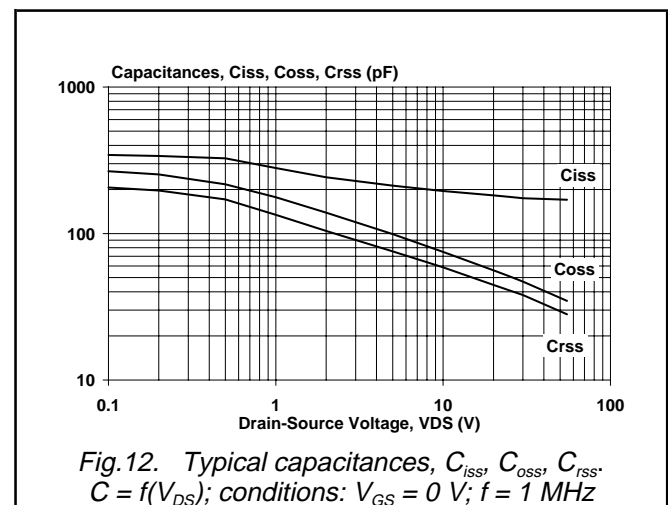
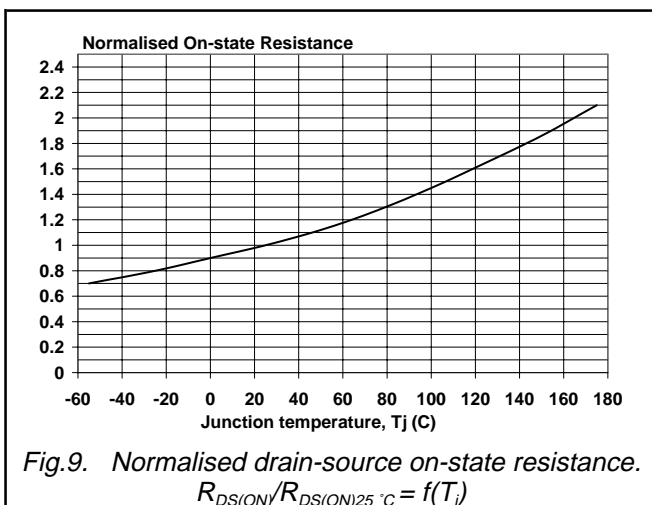
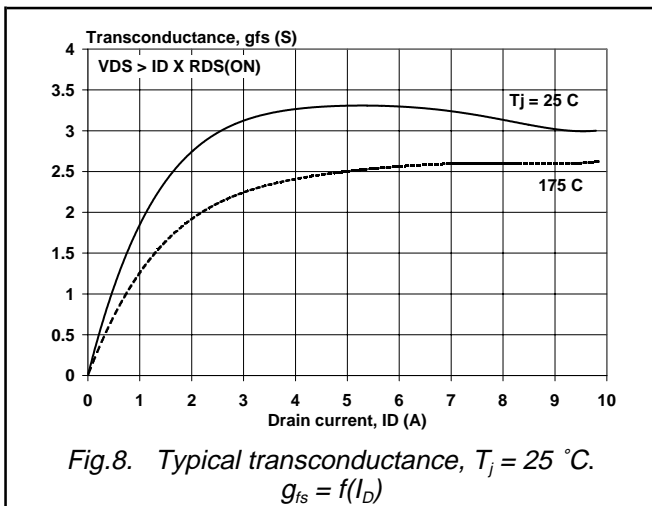
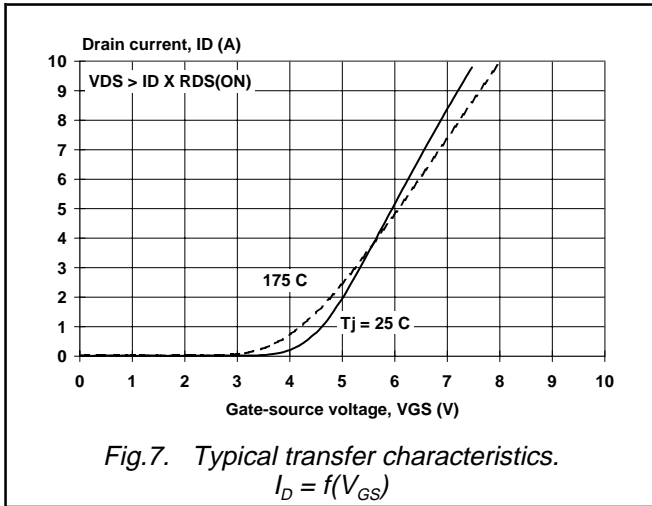

N-channel TrenchMOS™ transistor

PHX3055E

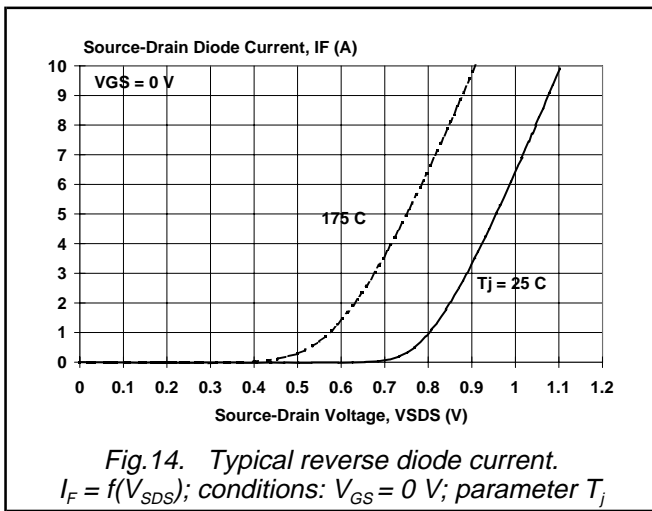
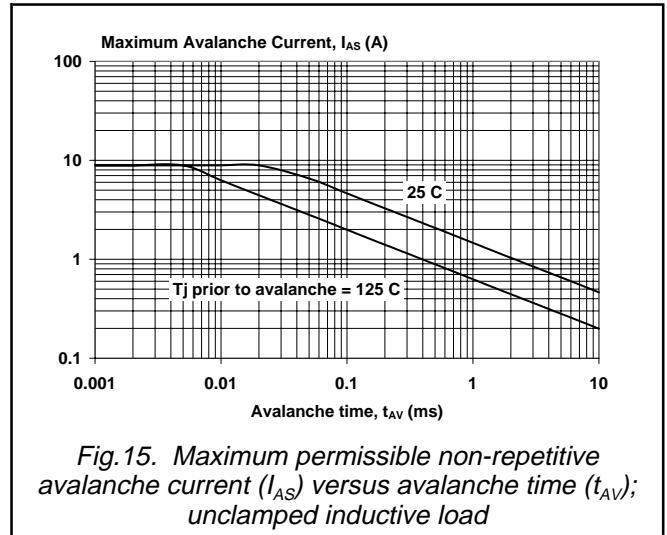
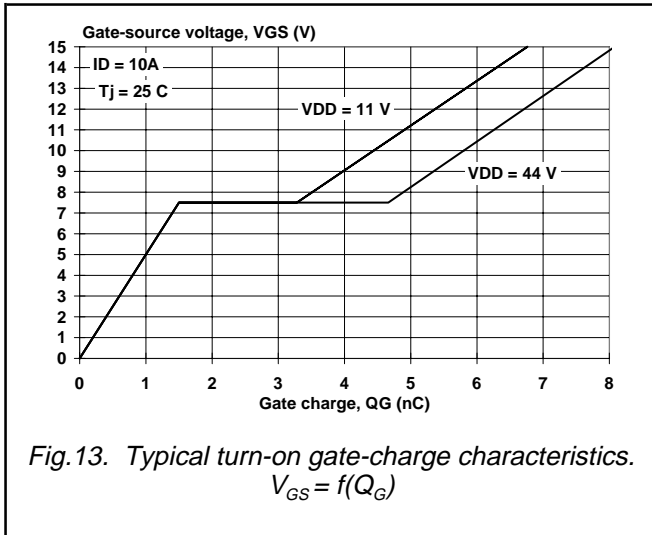

N-channel TrenchMOS™ transistor

PHX3055E

MECHANICAL DATA

Dimensions in mm

Plastic single-ended package; isolated heatsink mounted; 1 mounting hole; 3 lead TO-220

SOT186A

Net Mass: 2 g

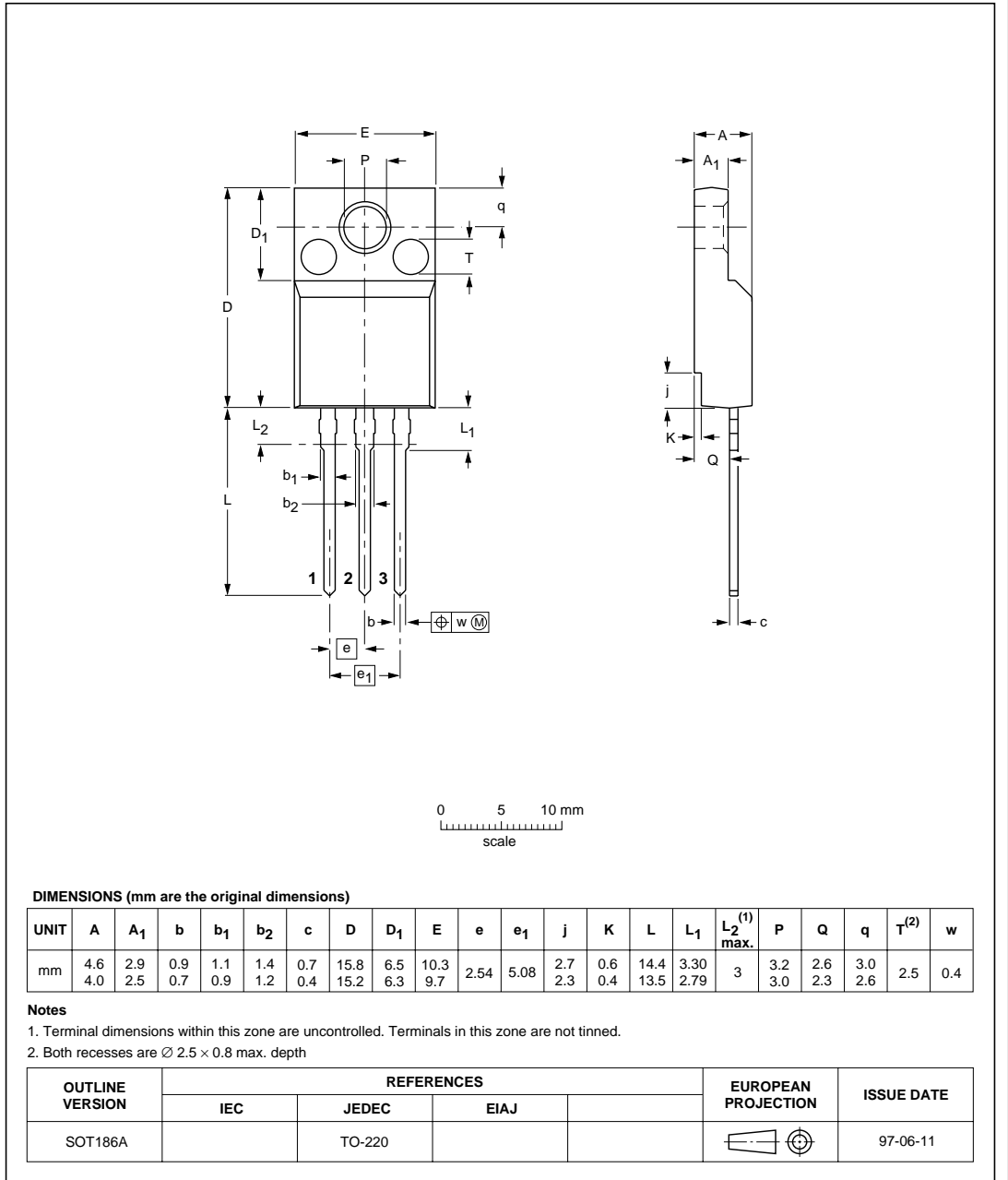

Fig. 16. SOT186A; The seating plane is electrically isolated from all terminals.

Notes

- Observe the general handling precautions for electrostatic-discharge sensitive devices (ESDs) to prevent damage to MOS gate oxide.
- Refer to mounting instructions for F-pack envelopes.
- Epoxy meets UL94 V0 at 1/8".

N-channel TrenchMOS™ transistor

PHX3055E

DEFINITIONS

Data sheet status	
Objective specification	This data sheet contains target or goal specifications for product development.
Preliminary specification	This data sheet contains preliminary data; supplementary data may be published later.
Product specification	This data sheet contains final product specifications.
Limiting values	
Limiting values are given in accordance with the Absolute Maximum Rating System (IEC 134). Stress above one or more of the limiting values may cause permanent damage to the device. These are stress ratings only and operation of the device at these or at any other conditions above those given in the Characteristics sections of this specification is not implied. Exposure to limiting values for extended periods may affect device reliability.	
Application information	
Where application information is given, it is advisory and does not form part of the specification.	
© Philips Electronics N.V. 1999	
All rights are reserved. Reproduction in whole or in part is prohibited without the prior written consent of the copyright owner.	
The information presented in this document does not form part of any quotation or contract, it is believed to be accurate and reliable and may be changed without notice. No liability will be accepted by the publisher for any consequence of its use. Publication thereof does not convey nor imply any license under patent or other industrial or intellectual property rights.	

LIFE SUPPORT APPLICATIONS

These products are not designed for use in life support appliances, devices or systems where malfunction of these products can be reasonably expected to result in personal injury. Philips customers using or selling these products for use in such applications do so at their own risk and agree to fully indemnify Philips for any damages resulting from such improper use or sale.