

# Thyristor logic level

BT169DW

## GENERAL DESCRIPTION

Glass passivated, sensitive gate thyristor in a plastic envelope, suitable for surface mounting, intended for use in general purpose switching and phase control applications. This device is intended to be interfaced directly to microcontrollers, logic integrated circuits and other low power gate trigger circuits.

## QUICK REFERENCE DATA

SYMBOL	PARAMETER	MAX.	UNIT
$V_{DRM}$ , $V_{RRM}$	Repetitive peak off-state voltages	400	V
$I_{T(AV)}$	Average on-state current	0.6	A
$I_{T(RMS)}$	RMS on-state current	1	A
$I_{TSM}$	Non-repetitive peak on-state current	8	A

## PINNING - SOT223

PIN	DESCRIPTION
1	cathode
2	anode
3	gate
tab	anode

## PIN CONFIGURATION

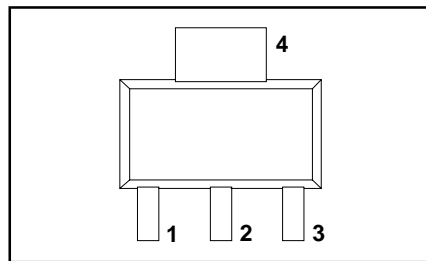

## SYMBOL

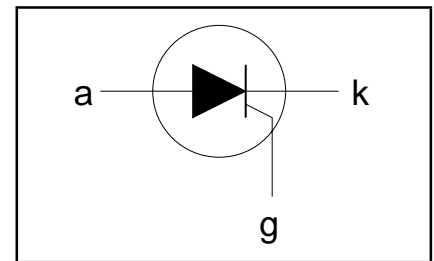

## LIMITING VALUES

Limiting values in accordance with the Absolute Maximum System (IEC 134).

SYMBOL	PARAMETER	CONDITIONS	MIN.	MAX.	UNIT
$V_{DRM}$ , $V_{RRM}$	Repetitive peak off-state voltages		-	400 <sup>1</sup>	V
$I_{T(AV)}$	Average on-state current	half sine wave; $T_{sp} \leq 112\text{ }^\circ\text{C}$	-	0.63	A
$I_{T(RMS)}$	RMS on-state current	all conduction angles	-	1	A
$I_{TSM}$	Non-repetitive peak on-state current	half sine wave; $T_j = 125\text{ }^\circ\text{C}$ prior to surge; with reapplied $V_{DRM(max)}$	-	8	A
		$t = 10\text{ ms}$	-	9	A
		$t = 8.3\text{ ms}$	-	0.32	$\text{A}^2\text{s}$
		$t = 10\text{ ms}$	-	50	$\text{A}/\mu\text{s}$
$I^2t$	$I^2t$ for fusing	$I_{TM} = 2\text{ A}$ ; $I_G = 10\text{ mA}$ ; $dI_G/dt = 100\text{ mA}/\mu\text{s}$	-		
$dI_T/dt$	Repetitive rate of rise of on-state current after triggering		-		
$I_{GM}$	Peak gate current		-	1	A
$V_{GM}$	Peak gate voltage		-	5	V
$V_{RGM}$	Peak reverse gate voltage		-	5	V
$P_{GM}$	Peak gate power		-	2	W
$P_{G(AV)}$	Average gate power	over any 20 ms period	-	0.1	W
$T_{stg}$	Storage temperature		-40	150	$^\circ\text{C}$
$T_j$	Operating junction temperature		-	125	$^\circ\text{C}$

<sup>1</sup> Although not recommended, off-state voltages up to 800V may be applied without damage, but the thyristor may switch to the on-state. The rate of rise of current should not exceed 15 A/ $\mu\text{s}$ .

Thyristor  
logic level

BT169DW

**THERMAL RESISTANCES**

SYMBOL	PARAMETER	CONDITIONS	MIN.	TYP.	MAX.	UNIT
$R_{th\ j-sp}$	Thermal resistance junction to solder point		-	-	15	K/W
$R_{th\ j-a}$	Thermal resistance junction to ambient	pcb mounted, minimum footprint pcb mounted; pad area as in fig:14	-	156 70	-	K/W K/W

**STATIC CHARACTERISTICS** $T_j = 25\text{ }^\circ\text{C}$  unless otherwise stated

SYMBOL	PARAMETER	CONDITIONS	MIN.	TYP.	MAX.	UNIT
$I_{GT}$	Gate trigger current	$V_D = 12\text{ V}$ ; $I_T = 10\text{ mA}$ ; gate open circuit	-	50	200	$\mu\text{A}$
$I_L$	Latching current	$V_D = 12\text{ V}$ ; $I_{GT} = 0.5\text{ mA}$ ; $R_{GK} = 1\text{ k}\Omega$	-	2	6	mA
$I_H$	Holding current	$V_D = 12\text{ V}$ ; $I_{GT} = 0.5\text{ mA}$ ; $R_{GK} = 1\text{ k}\Omega$	-	2	5	mA
$V_T$	On-state voltage	$I_T = 2\text{ A}$	-	1.35	1.5	V
$V_{GT}$	Gate trigger voltage	$V_D = 12\text{ V}$ ; $I_T = 10\text{ mA}$ ; gate open circuit	-	0.5	0.8	V
		$V_D = V_{DRM(max)}$ ; $I_T = 10\text{ mA}$ ; $T_j = 125\text{ }^\circ\text{C}$ ; gate open circuit	0.2	0.3	-	V
$I_D, I_R$	Off-state leakage current	$V_D = V_{DRM(max)}$ ; $V_R = V_{RRM(max)}$ ; $T_j = 125\text{ }^\circ\text{C}$ ; $R_{GK} = 1\text{ k}\Omega$	-	0.05	0.1	mA

**DYNAMIC CHARACTERISTICS** $T_j = 25\text{ }^\circ\text{C}$  unless otherwise stated

SYMBOL	PARAMETER	CONDITIONS	MIN.	TYP.	MAX.	UNIT
$dV_D/dt$	Critical rate of rise of off-state voltage	$V_{DM} = 67\% V_{DRM(max)}$ ; $T_j = 125\text{ }^\circ\text{C}$ ; exponential waveform; $R_{GK} = 1\text{ k}\Omega$	-	25	-	V/ $\mu\text{s}$
$t_{gt}$	Gate controlled turn-on time	$I_{TM} = 2\text{ A}$ ; $V_D = V_{DRM(max)}$ ; $I_G = 10\text{ mA}$ ; $di_G/dt = 0.1\text{ A}/\mu\text{s}$	-	2	-	$\mu\text{s}$
$t_q$	Circuit commutated turn-off time	$V_D = 67\% V_{DRM(max)}$ ; $T_j = 125\text{ }^\circ\text{C}$ ; $I_{TM} = 1.6\text{ A}$ ; $V_R = 35\text{ V}$ ; $di_{TM}/dt = 30\text{ A}/\mu\text{s}$ ; $dV_D/dt = 2\text{ V}/\mu\text{s}$ ; $R_{GK} = 1\text{ k}\Omega$	-	100	-	$\mu\text{s}$

Thyristor  
logic level

BT169DW

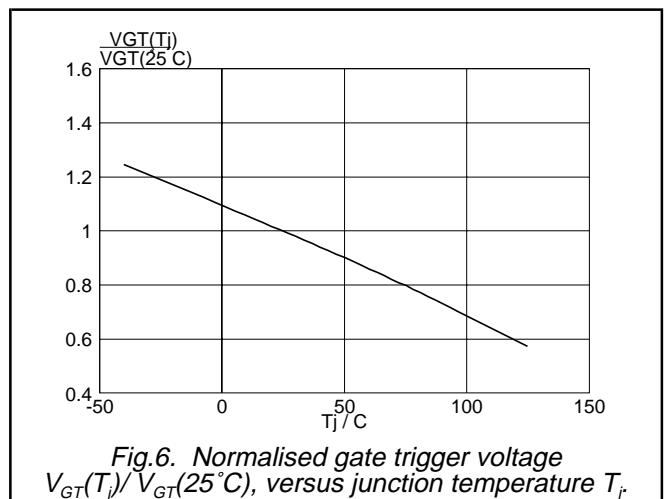
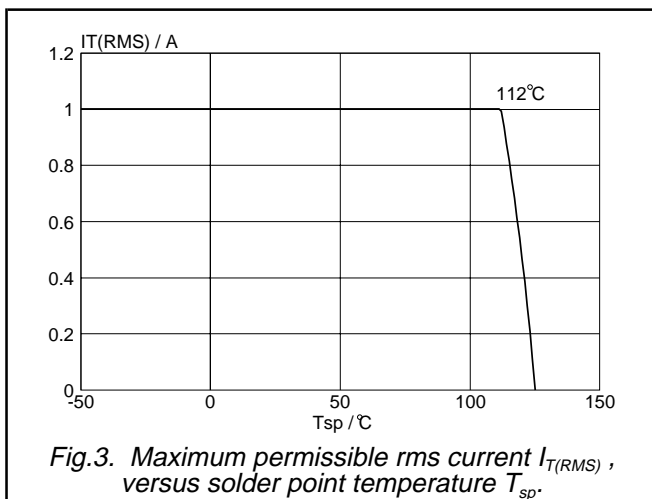
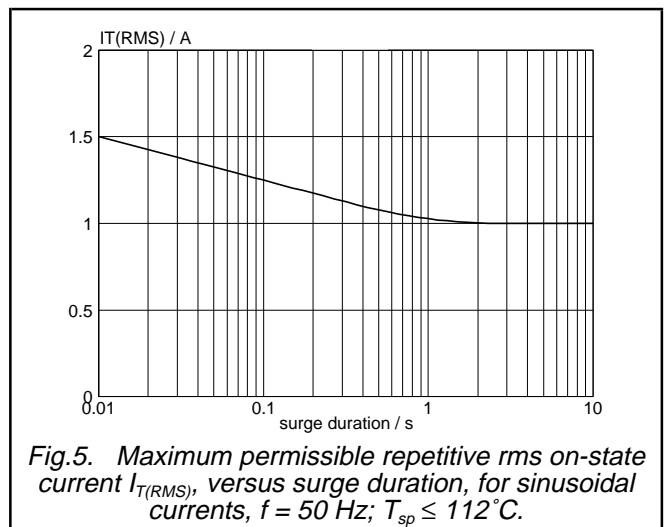
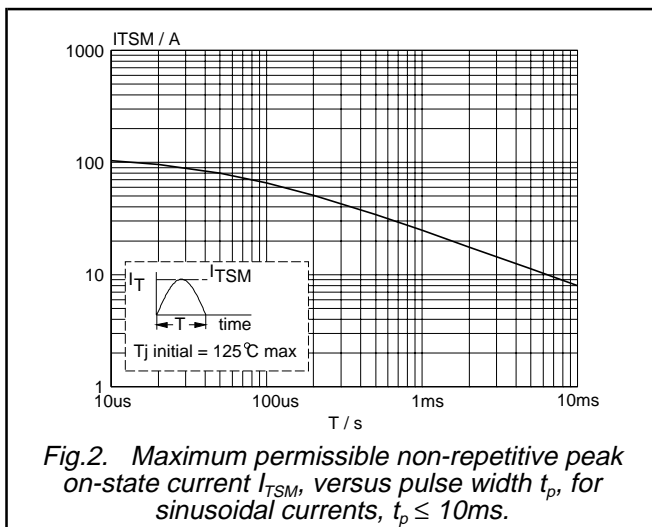
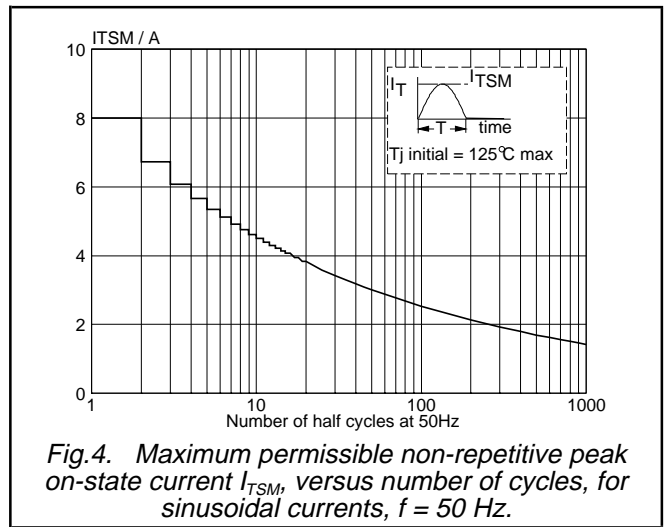
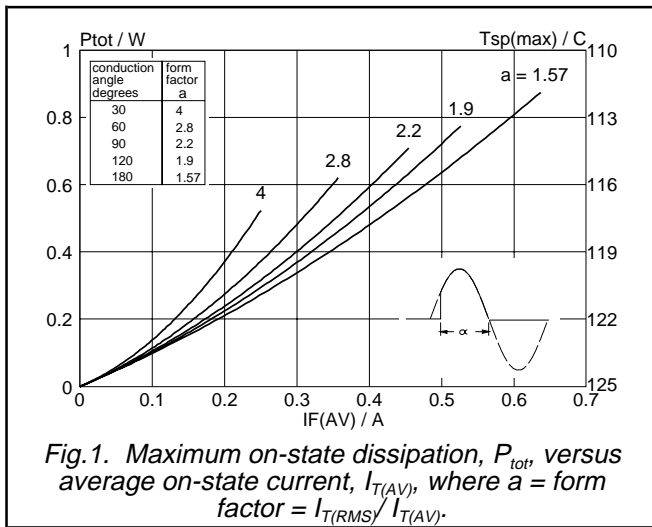

Thyristor  
logic level

BT169DW

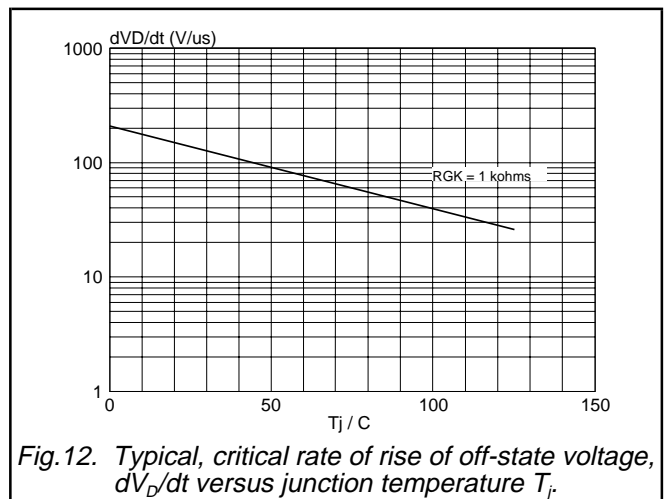
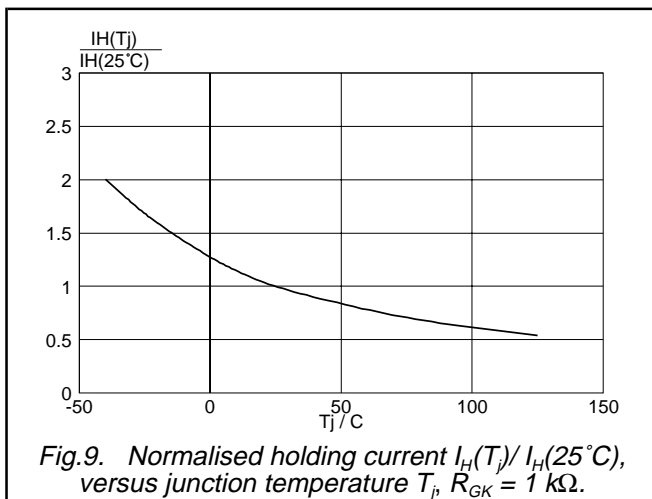
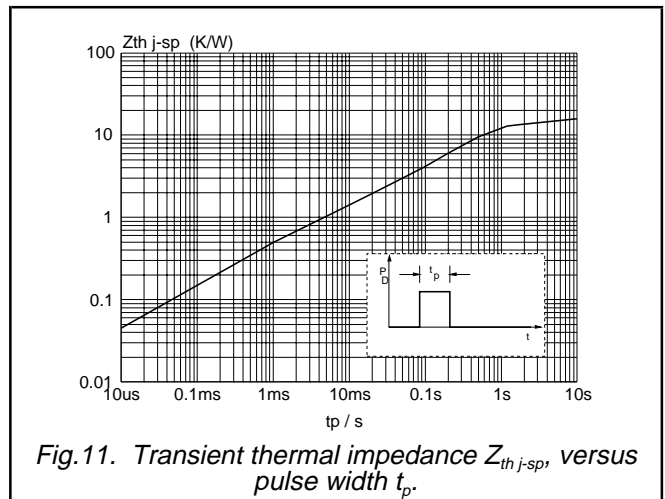
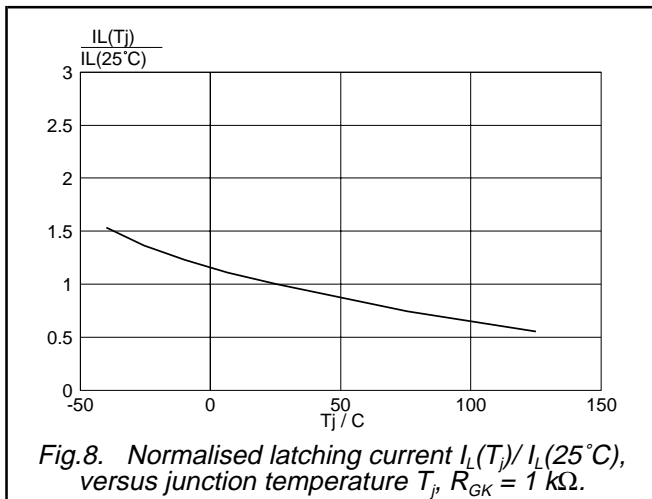
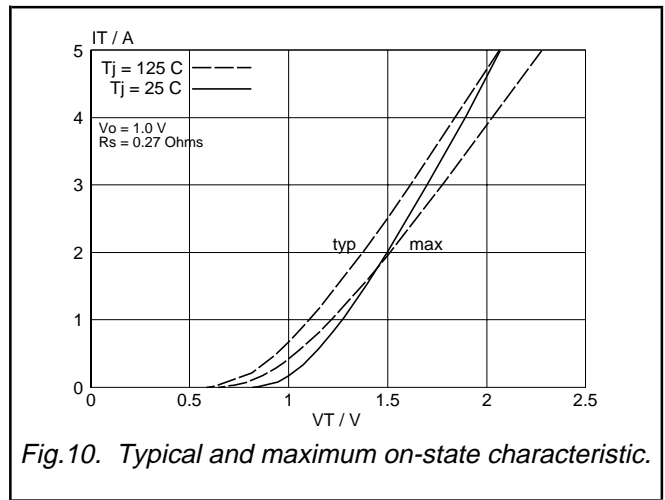
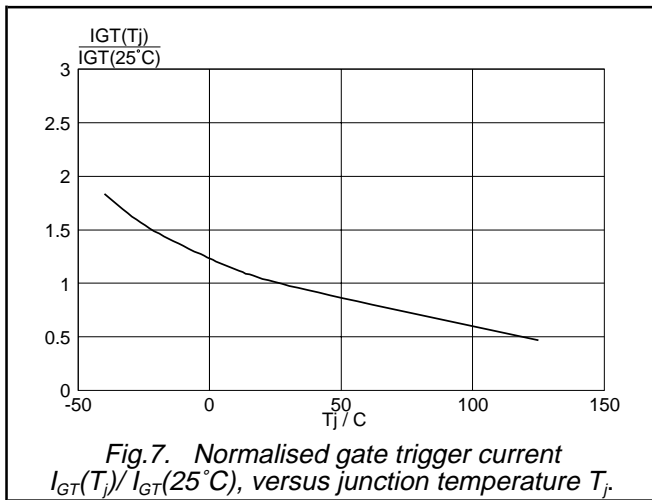

Thyristor  
logic level

BT169DW

**MOUNTING INSTRUCTIONS**

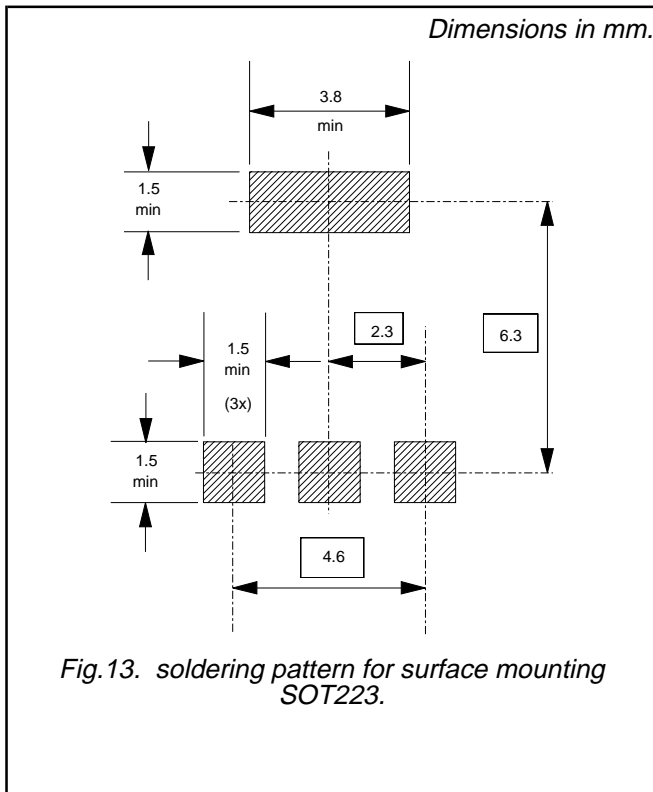

**PRINTED CIRCUIT BOARD**

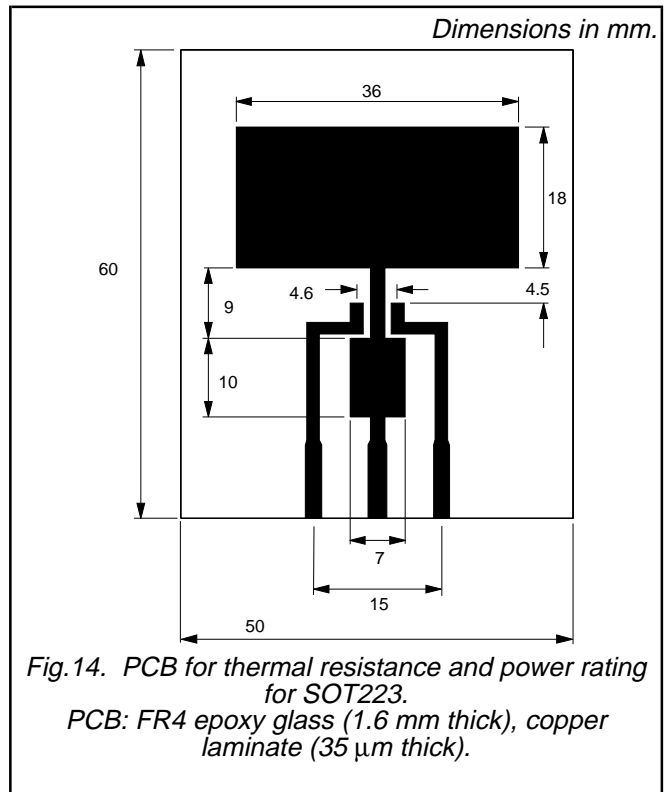

Thyristor  
logic level

BT169DW

**MECHANICAL DATA**

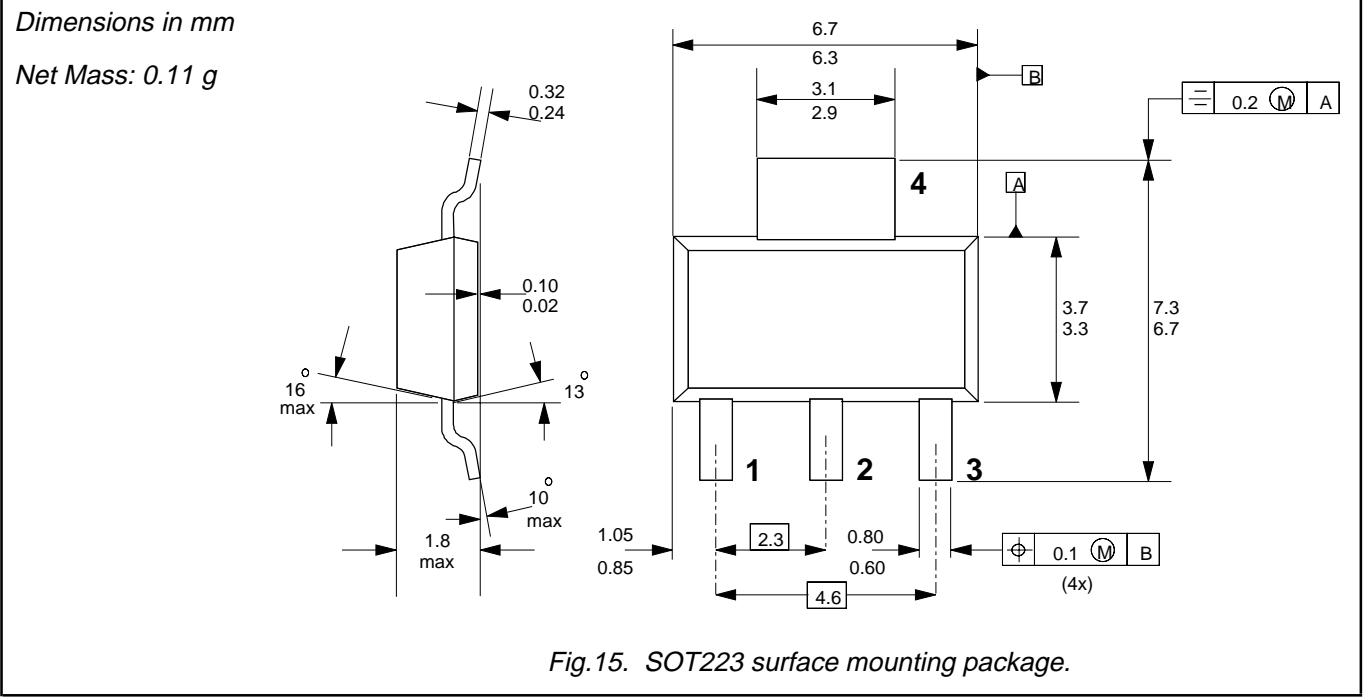

**Notes**

1. For further information, refer to surface mounting instructions for SOT223 envelope.
2. Epoxy meets UL94 V0 at 1/8".

Thyristor  
logic level

BT169DW

## DEFINITIONS

<b>Data sheet status</b>	
Objective specification	This data sheet contains target or goal specifications for product development.
Preliminary specification	This data sheet contains preliminary data; supplementary data may be published later.
Product specification	This data sheet contains final product specifications.
<b>Limiting values</b>	
Limiting values are given in accordance with the Absolute Maximum Rating System (IEC 134). Stress above one or more of the limiting values may cause permanent damage to the device. These are stress ratings only and operation of the device at these or at any other conditions above those given in the Characteristics sections of this specification is not implied. Exposure to limiting values for extended periods may affect device reliability.	
<b>Application information</b>	
Where application information is given, it is advisory and does not form part of the specification.	
© Philips Electronics N.V. 1996	
All rights are reserved. Reproduction in whole or in part is prohibited without the prior written consent of the copyright owner.	
The information presented in this document does not form part of any quotation or contract, it is believed to be accurate and reliable and may be changed without notice. No liability will be accepted by the publisher for any consequence of its use. Publication thereof does not convey nor imply any license under patent or other industrial or intellectual property rights.	

## LIFE SUPPORT APPLICATIONS

These products are not designed for use in life support appliances, devices or systems where malfunction of these products can be reasonably expected to result in personal injury. Philips customers using or selling these products for use in such applications do so at their own risk and agree to fully indemnify Philips for any damages resulting from such improper use or sale.