

PowerMOS transistor

BUK465-100A

GENERAL DESCRIPTION

N-channel enhancement mode field-effect power transistor in a plastic envelope suitable for surface mount applications.

The device is intended for use in Switched Mode Power Supplies (SMPS), motor control, welding, DC/DC and AC/DC converters, and in general purpose switching applications.

QUICK REFERENCE DATA

SYMBOL	PARAMETER	MAX.	UNIT
V_{DS}	Drain-source voltage	100	V
I_D	Drain current (DC)	26	A
P_{tot}	Total power dissipation	125	W
T_j	Junction temperature	175	°C
$R_{DS(ON)}$	Drain-source on-state resistance	0.08	Ω

PINNING - SOT404

PIN	DESCRIPTION
1	gate
2	drain
3	source
mb	drain

PIN CONFIGURATION

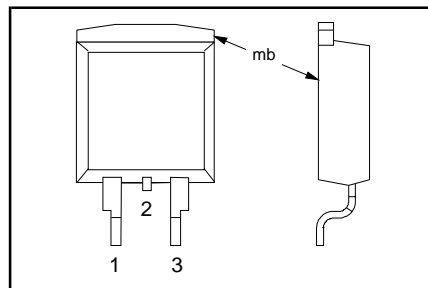

SYMBOL

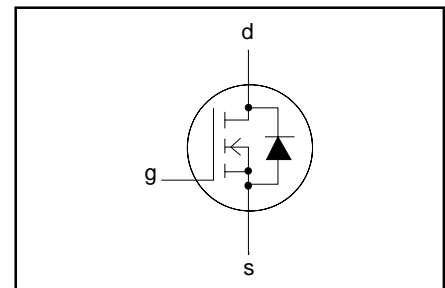

LIMITING VALUES

Limiting values in accordance with the Absolute Maximum System (IEC 134)

SYMBOL	PARAMETER	CONDITIONS	MIN.	MAX.	UNIT
V_{DS}	Drain-source voltage	-	-	100	V
V_{DGR}	Drain-gate voltage	$R_{GS} = 20\text{ k}\Omega$	-	100	V
$\pm V_{GS}$	Gate-source voltage	-	-	30	V
I_D	Drain current (DC)	$T_{mb} = 25\text{ }^\circ\text{C}$	-	26	A
I_D	Drain current (DC)	$T_{mb} = 100\text{ }^\circ\text{C}$	-	18	A
I_{DM}	Drain current (pulse peak value)	$T_{mb} = 25\text{ }^\circ\text{C}$	-	104	A
P_{tot}	Total power dissipation	$T_{mb} = 25\text{ }^\circ\text{C}$	-	125	W
T_{stg}	Storage temperature	-	- 55	175	°C
T_j	Junction temperature	-	-	175	°C

THERMAL RESISTANCES

SYMBOL	PARAMETER	CONDITIONS	MIN.	TYP.	MAX.	UNIT
$R_{th\text{-j-mb}}$	Thermal resistance junction to mounting base		-	-	1.2	K/W
$R_{th\text{-j-a}}$	Thermal resistance junction to ambient	minimum footprint FR4 board (see Fig 18).	-	50	-	K/W

PowerMOS transistor

BUK465-100A

STATIC CHARACTERISTICS $T_{mb} = 25\text{ °C}$ unless otherwise specified

SYMBOL	PARAMETER	CONDITIONS	MIN.	TYP.	MAX.	UNIT
$V_{(BR)DSS}$	Drain-source breakdown voltage	$V_{GS} = 0\text{ V}; I_D = 0.25\text{ mA}$	100	-	-	V
$V_{GS(TO)}$	Gate threshold voltage	$V_{DS} = V_{GS}; I_D = 1\text{ mA}$	2.1	3.0	4.0	V
I_{DSS}	Zero gate voltage drain current	$V_{DS} = 100\text{ V}; V_{GS} = 0\text{ V}; T_j = 25\text{ °C}$	-	1	10	μA
I_{DSS}	Zero gate voltage drain current	$V_{DS} = 100\text{ V}; V_{GS} = 0\text{ V}; T_j = 125\text{ °C}$	-	0.1	1.0	mA
I_{GSS}	Gate source leakage current	$V_{GS} = \pm 30\text{ V}; V_{DS} = 0\text{ V}$	-	10	100	nA
$R_{DS(ON)}$	Drain-source on-state resistance	$V_{GS} = 10\text{ V}; I_D = 13\text{ A}$	-	0.07	0.08	Ω

DYNAMIC CHARACTERISTICS $T_{mb} = 25\text{ °C}$ unless otherwise specified

SYMBOL	PARAMETER	CONDITIONS	MIN.	TYP.	MAX.	UNIT
g_{fs}	Forward transconductance	$V_{DS} = 25\text{ V}; I_D = 13\text{ A}$	7.0	13.5	-	S
C_{iss}	Input capacitance	$V_{GS} = 0\text{ V}; V_{DS} = 25\text{ V}; f = 1\text{ MHz}$	-	1650	2000	pF
C_{oss}	Output capacitance		-	350	500	pF
C_{rss}	Feedback capacitance		-	100	150	pF
t_{don}	Turn-on delay time	$V_{DD} = 30\text{ V}; I_D = 3\text{ A};$ $V_{GS} = 10\text{ V}; R_{GS} = 50\text{ }\Omega;$ $R_{gen} = 50\text{ }\Omega$	-	15	30	ns
t_r	Turn-on rise time		-	25	40	ns
t_{doff}	Turn-off delay time		-	100	160	ns
t_f	Turn-off fall time		-	50	80	ns
L_d	Internal drain inductance	Measured from upper edge of drain tab to centre of die	-	2.5	-	nH
L_s	Internal source inductance	Measured from source lead soldering point to source bond pad	-	7.5	-	nH

REVERSE DIODE LIMITING VALUES AND CHARACTERISTICS $T_{mb} = 25\text{ °C}$ unless otherwise specified

SYMBOL	PARAMETER	CONDITIONS	MIN.	TYP.	MAX.	UNIT
I_{DR}	Continuous reverse drain current	-	-	-	26	A
I_{DRM}	Pulsed reverse drain current	-	-	-	104	A
V_{SD}	Diode forward voltage	$I_F = 26\text{ A}; V_{GS} = 0\text{ V}$	-	1.3	1.7	V
t_{rr}	Reverse recovery time	$I_F = 26\text{ A}; -di_F/dt = 100\text{ A}/\mu\text{s};$ $V_{GS} = 0\text{ V}; V_R = 30\text{ V}$	-	90	-	ns
Q_{rr}	Reverse recovery charge		-	0.8	-	μC

AVALANCHE LIMITING VALUE $T_{mb} = 25\text{ °C}$ unless otherwise specified

SYMBOL	PARAMETER	CONDITIONS	MIN.	TYP.	MAX.	UNIT
W_{DSS}	Drain-source non-repetitive unclamped inductive turn-off energy	$I_D = 26\text{ A}; V_{DD} \leq 50\text{ V};$ $V_{GS} = 10\text{ V}; R_{GS} = 50\text{ }\Omega$	-	-	100	mJ

PowerMOS transistor

BUK465-100A

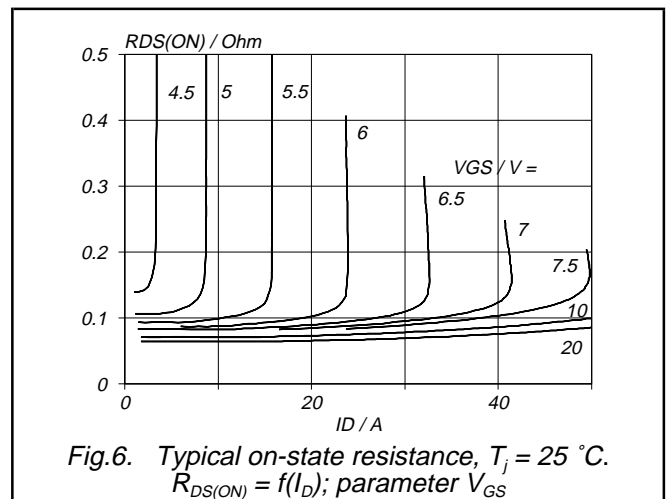
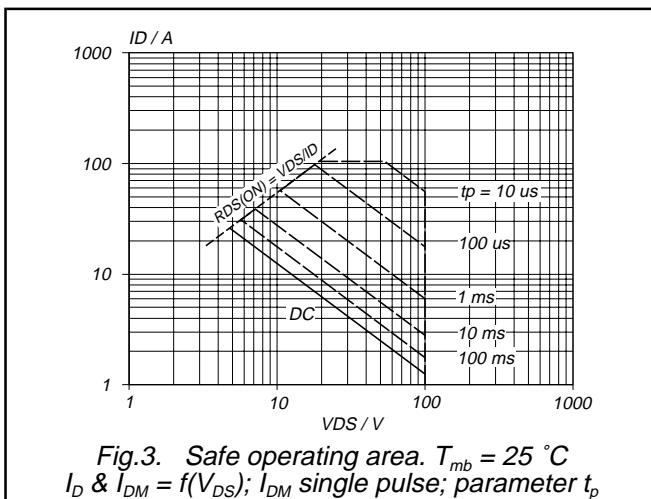
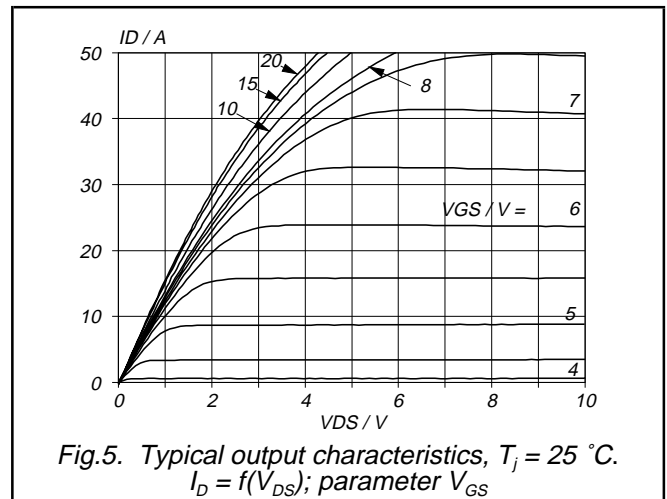
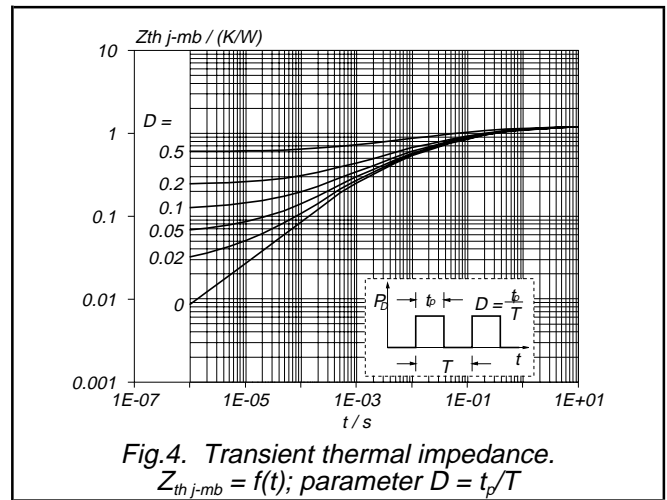

PowerMOS transistor

BUK465-100A

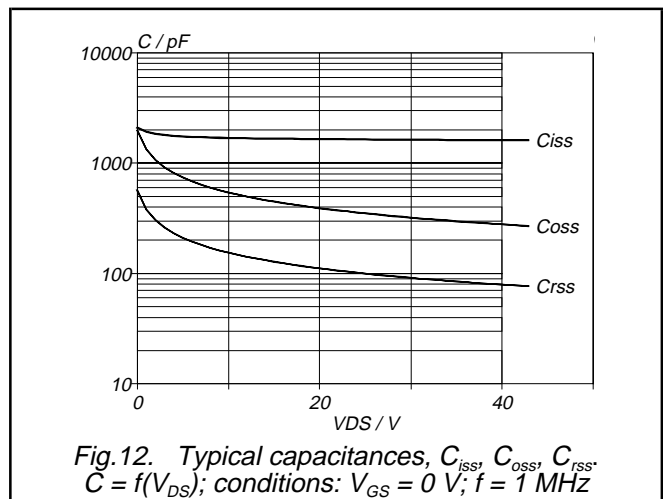
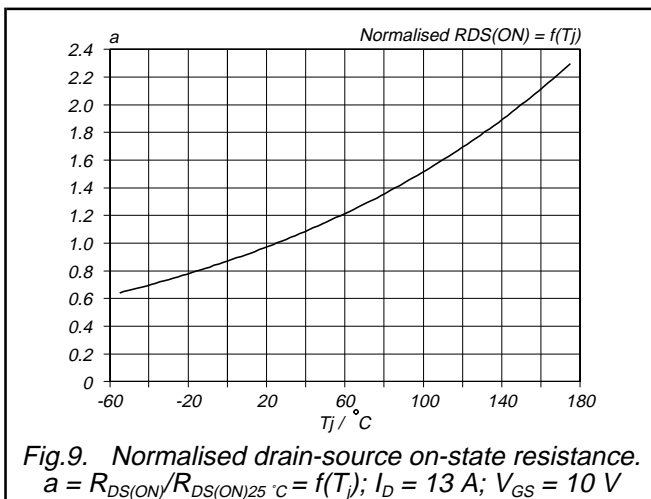
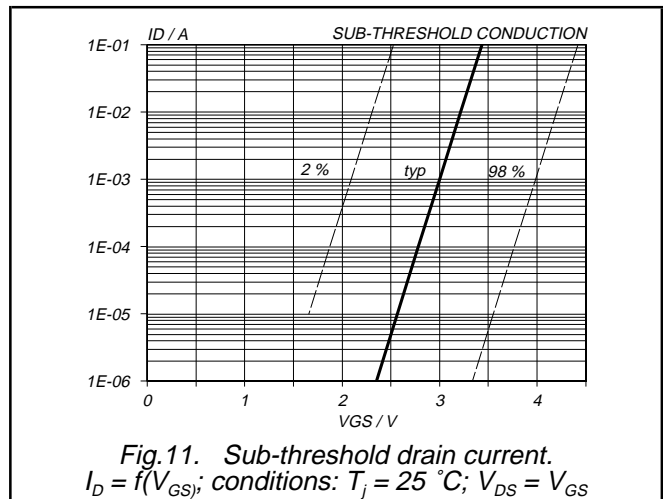
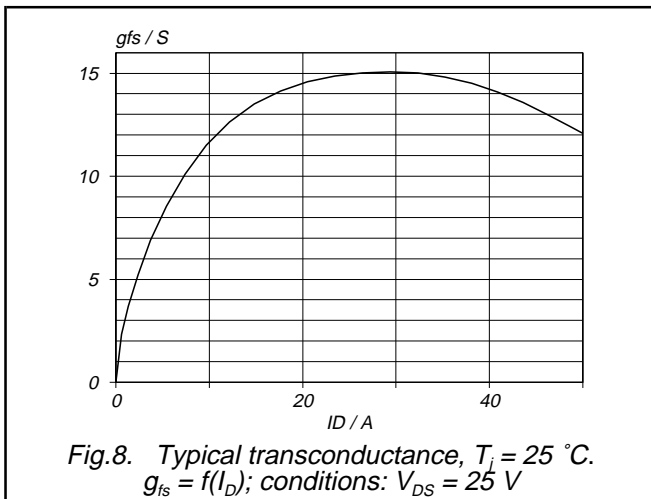
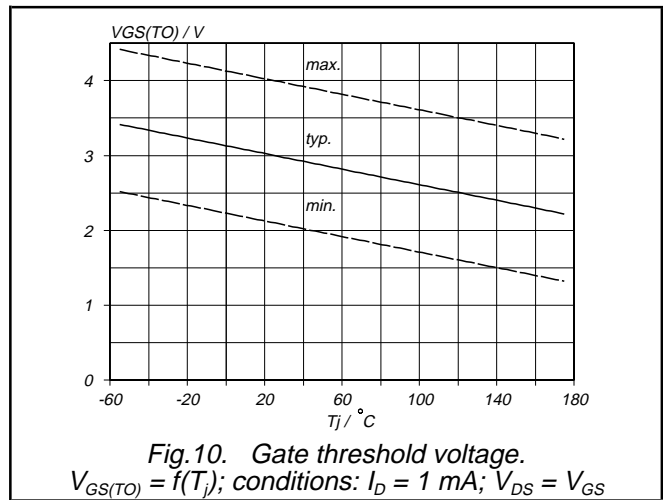
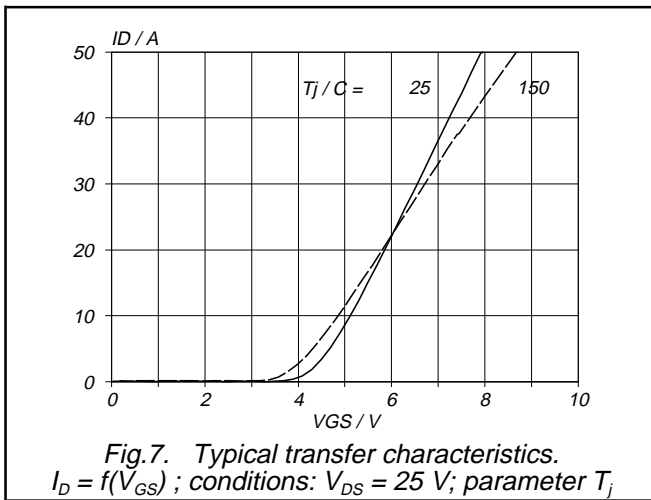

PowerMOS transistor

BUK465-100A

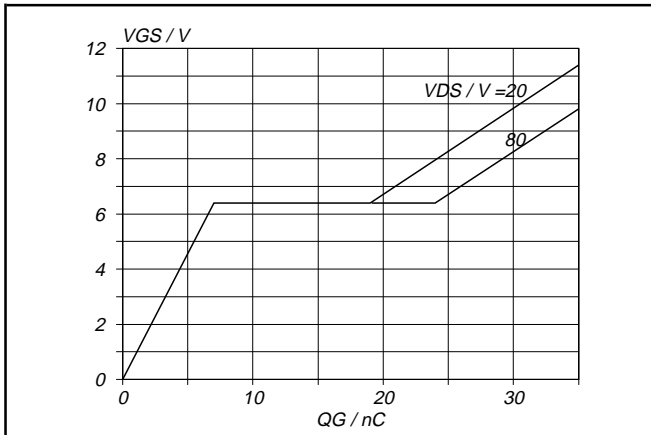

Fig. 13. Typical turn-on gate-charge characteristics.
 $V_{GS} = f(Q_G)$; conditions: $I_D = 26$ A; parameter V_{DS}

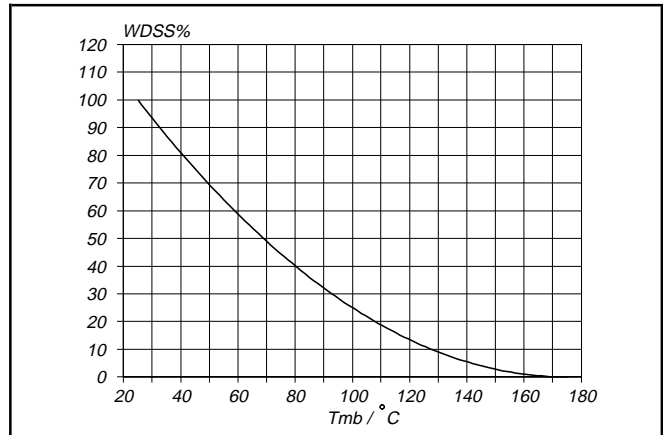

Fig. 15. Normalised avalanche energy rating.
 $W_{DSS}\% = f(T_{mb})$; conditions: $I_D = 26$ A

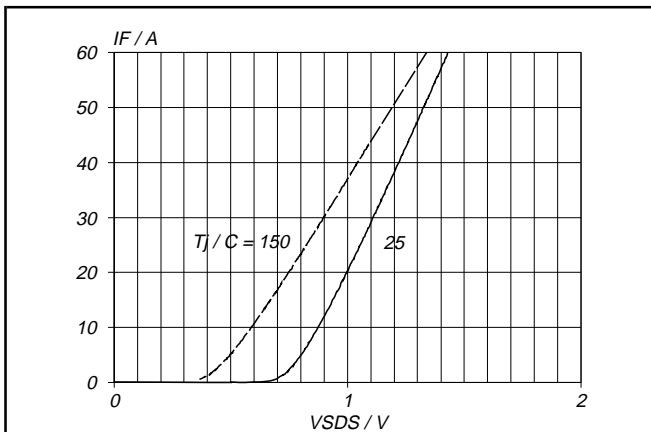

Fig. 14. Typical reverse diode current.
 $I_F = f(V_{SDS})$; conditions: $V_{GS} = 0$ V; parameter T_j

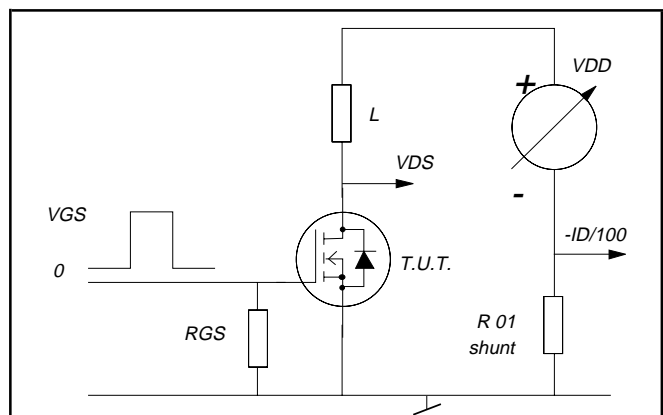

Fig. 16. Avalanche energy test circuit.
 $W_{DSS} = 0.5 \cdot L I_D^2 \cdot BV_{DSS} / (BV_{DSS} - V_{DD})$

MECHANICAL DATA

Dimensions in mm

Net Mass: 1.4 g

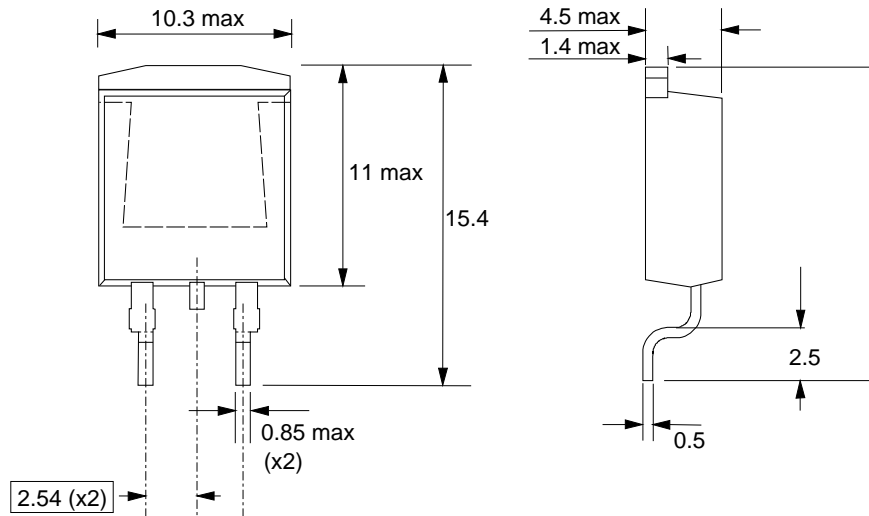

Fig.17. SOT404 : centre pin connected to mounting base.

MOUNTING INSTRUCTIONS

Dimensions in mm

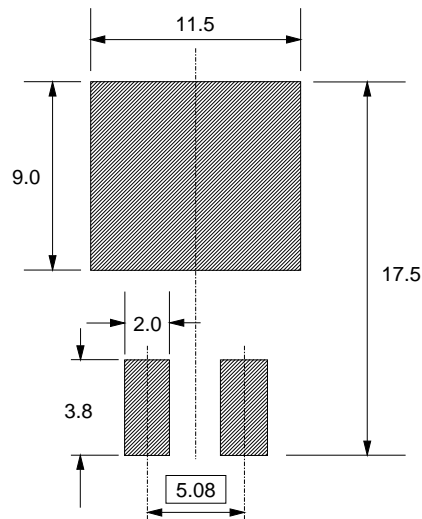

Fig.18. SOT404 : soldering pattern for surface mounting.

Notes

1. Observe the general handling precautions for electrostatic-discharge sensitive devices (ESDs) to prevent damage to MOS gate oxide.
2. Epoxy meets UL94 V0 at 1/8".

PowerMOS transistor

BUK465-100A

DEFINITIONS

Data sheet status	
Objective specification	This data sheet contains target or goal specifications for product development.
Preliminary specification	This data sheet contains preliminary data; supplementary data may be published later.
Product specification	This data sheet contains final product specifications.
Limiting values	
Limiting values are given in accordance with the Absolute Maximum Rating System (IEC 134). Stress above one or more of the limiting values may cause permanent damage to the device. These are stress ratings only and operation of the device at these or at any other conditions above those given in the Characteristics sections of this specification is not implied. Exposure to limiting values for extended periods may affect device reliability.	
Application information	
Where application information is given, it is advisory and does not form part of the specification.	
© Philips Electronics N.V. 1996	
All rights are reserved. Reproduction in whole or in part is prohibited without the prior written consent of the copyright owner.	
The information presented in this document does not form part of any quotation or contract, it is believed to be accurate and reliable and may be changed without notice. No liability will be accepted by the publisher for any consequence of its use. Publication thereof does not convey nor imply any license under patent or other industrial or intellectual property rights.	

LIFE SUPPORT APPLICATIONS

These products are not designed for use in life support appliances, devices or systems where malfunction of these products can be reasonably expected to result in personal injury. Philips customers using or selling these products for use in such applications do so at their own risk and agree to fully indemnify Philips for any damages resulting from such improper use or sale.