

DATA SHEET

FTT1010-M

Frame Transfer CCD Image Sensor

Product specification
File under Image Sensors

1999 September 21

Frame Transfer CCD Image Sensor

FTT1010-M

- 1-inch optical format
- 1M active pixels (1024H x 1024V)
- Progressive scan
- Excellent anti-blooming
- Variable electronic shuttering
- Square pixel structure
- H and V binning
- 100% optical fill factor
- High dynamic range (>72dB)
- High sensitivity
- Low dark current and fixed pattern noise
- Low read-out noise
- Data rate up to 2 x 40 MHz
- Mirrored and split read-out

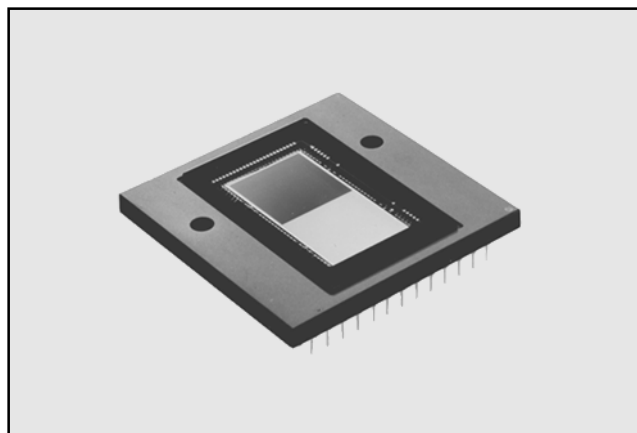

Description

The FTT 1010-M is a monochrome progressive-scan frame-transfer image sensor offering 1K x 1K pixels at 30 frames per second through a single output buffer. The combination of high speed and a high linear dynamic range (>12 true bits at room temperature without cooling) makes this device the perfect solution for high-end real time medical X-ray, scientific and industrial applications. A second output can either be used for mirrored images, or can be read out simultaneously with the other output to double the frame rate. The device structure is shown in figure 1.

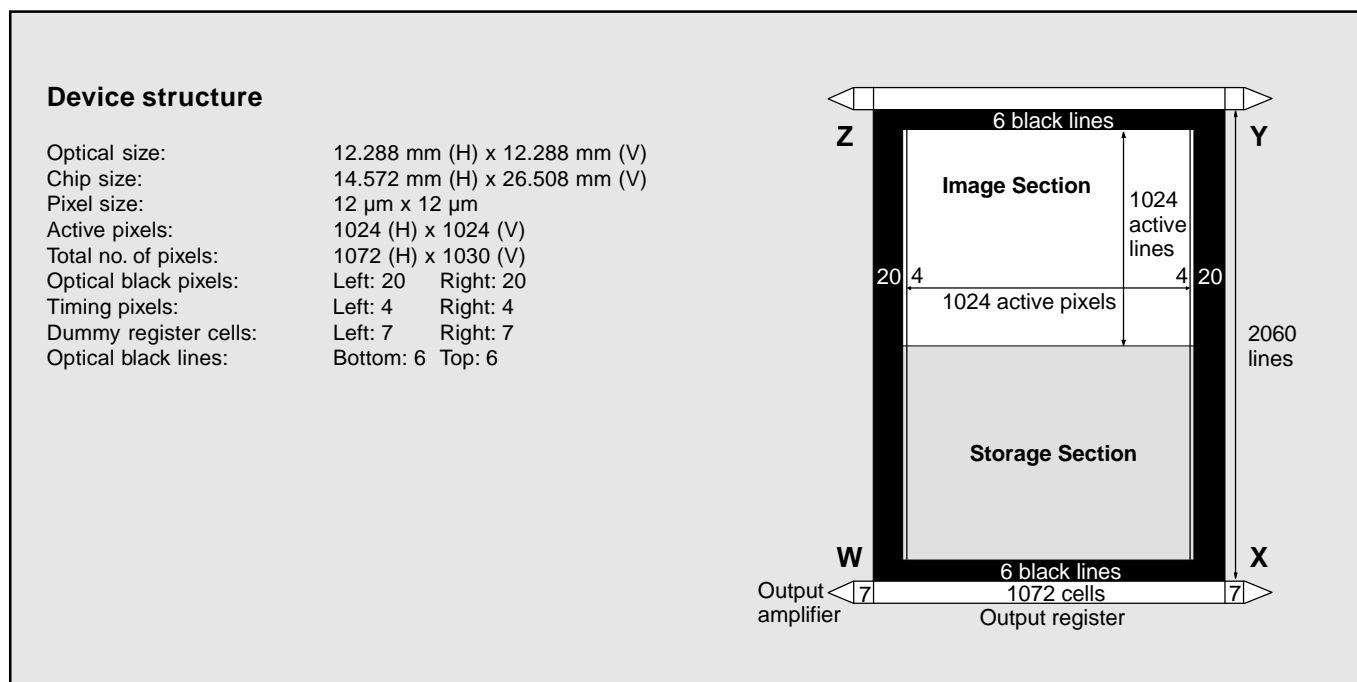

Figure 1 - Device structure

Frame Transfer CCD Image Sensor

FTT1010-M

Architecture of the FTT1010-M

The FTT1010-M consists of a shielded storage section and an open image section. Both sections are electronically the same and have the same cell structure with the same properties. The only difference between the two sections is the optical light shield.

The optical centres of all pixels in the image section form a square grid. The charge is generated and integrated in this section. Output registers are located below the storage section. The output amplifiers Y and Z are not used in Frame Transfer mode and should be connected as not-used amplifiers.

After the integration time the charge collected in the image section is shifted to the storage section. The charge is read out line by line through the lower output register.

The left and the right half of each output register can be controlled independently. This enables either single or multiple read-out.

During vertical transport the C3 gates separate the pixels in the register. The letters W, X, Y and Z are used to define the four quadrants of the sensor. The central C3 gates of both registers are part of the W and Z quadrants of the sensor.

Both upper and lower registers can be used for vertical binning. Both registers also have a summing gate at each end that can be used for horizontal binning. Figure 2 shows the detailed internal structure.

IMAGE SECTION	
Image diagonal (active video only)	17.38 mm
Aspect ratio	1:1
Active image width x height	12.288 x 12.288 mm ²
Pixel width x height	12x12 μm ²
Geometric fill factor	100%
Image clock pins	A1, A2, A3, A4
Capacity of each clock phase	2.5nF per pin
Number of active lines	1024
Number of black reference lines	2
Number of dummy black lines	4
Total number of lines	1030
Number of active pixels per line	1024
Number of overscan (timing) pixels per line	8 (2x4)
Number of black reference pixels per line	40 (2x20)
Total number of pixels per line	1072

STORAGE SECTION	
Storage width x height	12.864 x 12.360 mm ²
Cell width x height	12x12 μm ²
Storage clock phases	B1, B2, B3, B4
Capacity of each clock phase	2.5nF per pin
Number of cells per line	1072
Number of lines	1030

OUTPUT REGISTERS	
Output buffers (three-stage source follower)	4 (one on each corner)
Number of registers	2 (one above, one below)
Number of dummy cells per register	14 (2x7)
Number of register cells per register	1072
Output register horizontal transport clock pins	C1, C2, C3
Capacity of each C-clock phase	60pF per pin
Overlap capacity between neighbouring C-clocks	20pF
Output register Summing Gates	4 pins (SG)
Capacity of each SG	15pF
Reset Gate clock phases	4 pins (RG)
Capacity of each RG	15pF

Frame Transfer CCD Image Sensor

FTT1010-M

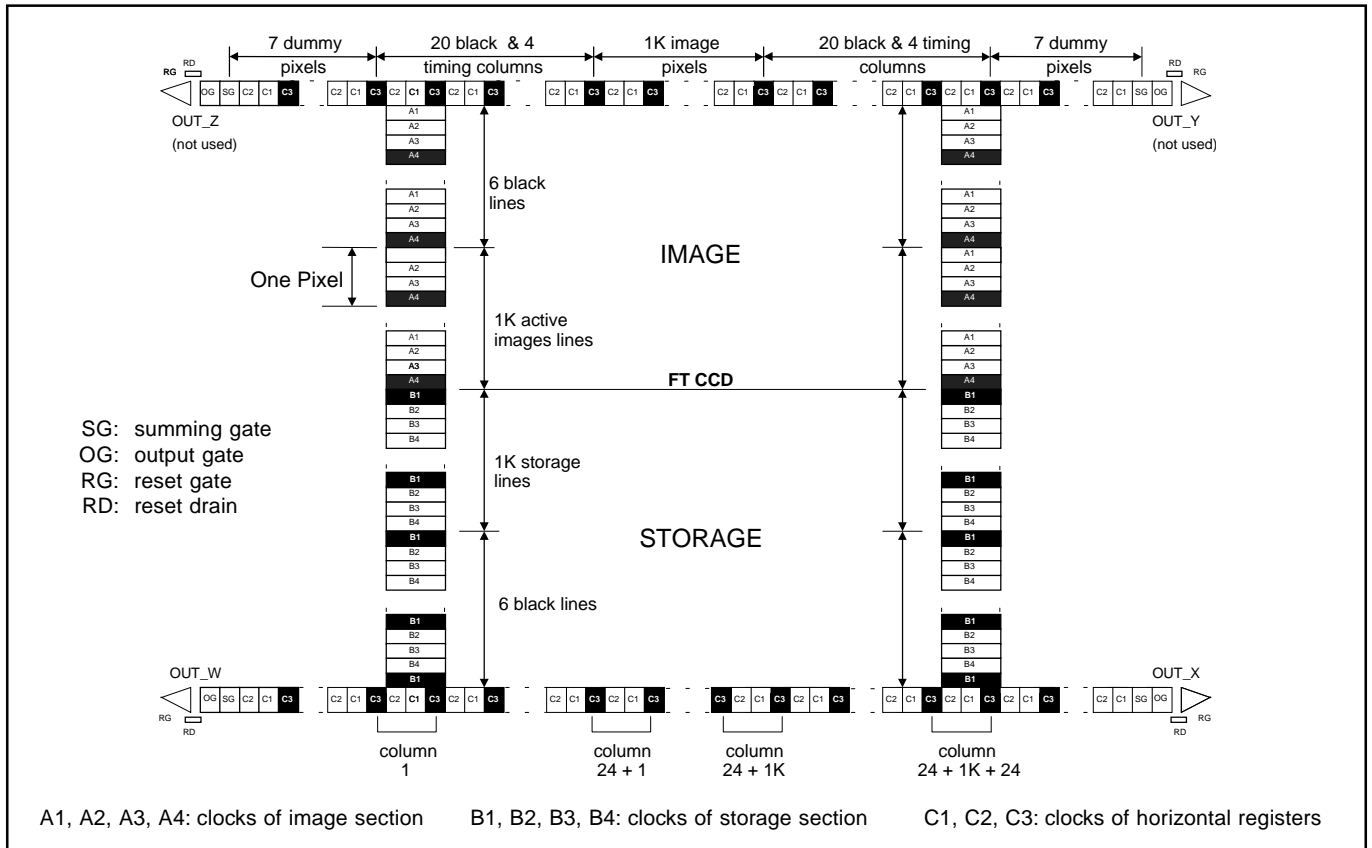

Figure 2 - Detailed internal structure

Frame Transfer CCD Image Sensor

FTT1010-M

Specifications

ABSOLUTE MAXIMUM RATINGS ¹	MIN.	MAX.	UNIT
GENERAL: storage temperature	-55	+80	°C
ambient temperature during operation	-40	+60	°C
voltage between any two gates	-20	+20	V
DC current through any clock phase (absolute value)	-0.2	+2.0	µA
OUT current (no short circuit protection)	0	10	mA
VOLTAGES IN RELATION TO VPS: VNS, SFD, RD	-0.5	+30	V
VCS, SFS	-8	+5	V
all other pins	-5	+25	V
VOLTAGES IN RELATION TO VNS: SFD, RD	-15	+0.5	V
VCS, SFS, VPS	-30	+0.5	V
all other pins	-30	+0.5	V

DC CONDITIONS ²		MIN. [V]	TYPICAL [V]	MAX. [V]	MAX. [mA]
VNS ³	N substrate	18	24	28	15
VPS	P substrate	1	3	7	15
SFD	Source Follower Drain	16	20	24	4.5
SFS	Source Follower Source	-	0	-	1
VCS	Current Source	-5	0	3	-
OG	Output Gate	4	6	8	-
RD	Reset Drain	13	15.5	18	-

AC CLOCK LEVEL CONDITIONS ²	MIN.	TYPICAL	MAX.	UNIT
IMAGE CLOCKS: A-clock amplitude during integration and hold	8	10		V
A-clock amplitude during vertical transport (duty cycle=5/8) ⁴	10	14		V
A-clock low level		0		V
Charge Reset (CR) level on A-clock ⁵	-5	-5		V
STORAGE CLOCKS: B-clock amplitude during hold	8	10		V
B-clock amplitude during vertical transport (duty cycle=5/8)	10	14		V
OUTPUT REGISTER CLOCKS: C-clock amplitude (duty cycle during hor. transport = 3/6)	4.75	5	5.25	V
C-clock low level	2	3.5		V
Summing Gate (SG) amplitude		10	10	V
Summing Gate (SG) low level		3.5		V
OTHER CLOCKS: Reset Gate (RG) amplitude	5	10	10	V
Reset Gate (RG) low level		3		V
Charge Reset (CR) pulse on Nsub ⁵	0	10	10	V

¹ During Charge Reset it is allowed to exceed maximum rating levels (see note⁵).

² All voltages in relation to SFS.

³ To set the VNS voltage for optimal Vertical Anti-Blooming (VAB), it should be adjustable between minimum and maximum values.

⁴ Three-level clock is preferred for maximum charge; the swing during vertical transport should be 4V higher than the voltage during integration. A two level clock (typically 10V) can be used if a lower maximum charge handling capacity is allowed.

⁵ Charge Reset can be achieved in two ways:

- The typical CR level is applied to all image clocks simultaneously (preferred).
- The typical A-clock low level is applied to all image clocks; for proper CR, an additional Charge Reset pulse on VNS is required. This will also affect the charge handling capacity in the storage areas.

Frame Transfer CCD Image Sensor

FTT1010-M

Timing diagrams (for default operation)

AC CHARACTERISTICS	MIN.	TYPICAL	MAX.	UNIT
Horizontal frequency (1/Tp) ¹	0	18	40	MHz
Vertical frequency	0	450	1000	kHz
Charge Reset (CR) time	2	5		µs
Rise and fall times: image clocks (A)	10	20		ns
storage clocks (B)	10	20		ns
register clocks (C) ²	3	5	1/6 Tp	ns
summing gate (SG)	3	5	1/6 Tp	ns
reset gate (RG)	3	5	1/6 Tp	ns

¹Tp = 1 clock period

²Duty cycle = 50% and phase shift of the C clocks is 120 degrees.

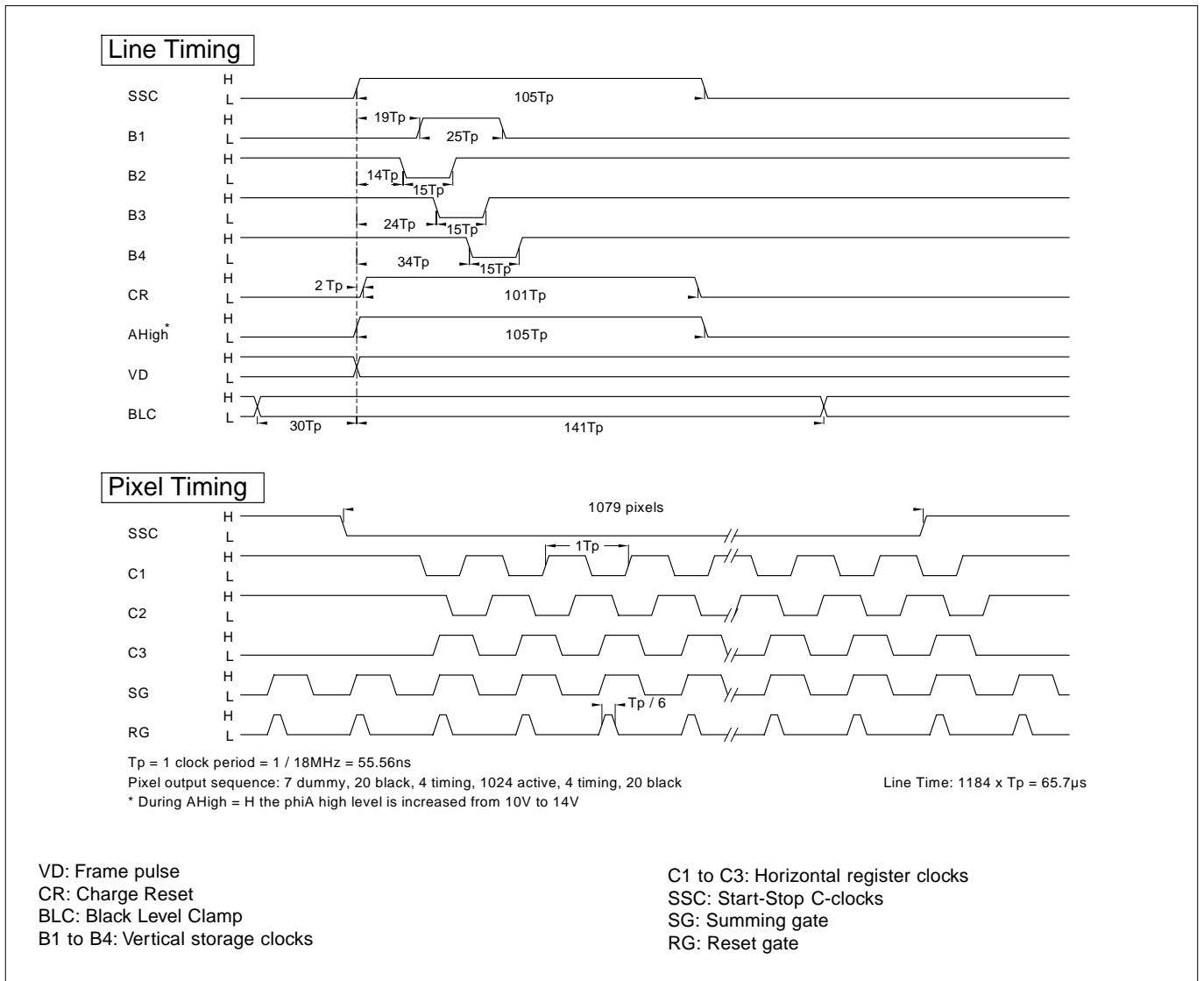
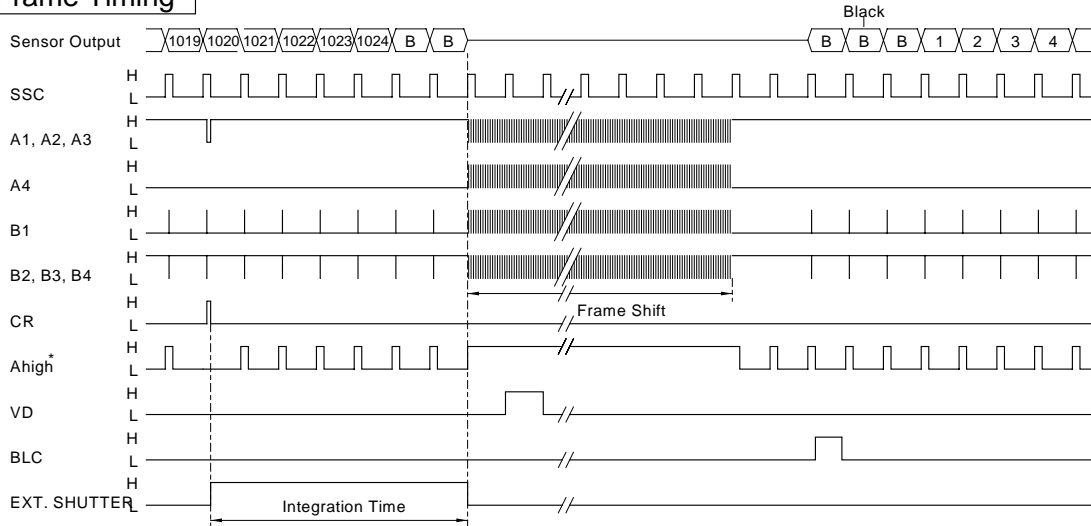

Figure 3 - Line and pixel timing diagrams

Frame Transfer CCD Image Sensor

FTT1010-M

Frame Timing



Frame Shift Timing

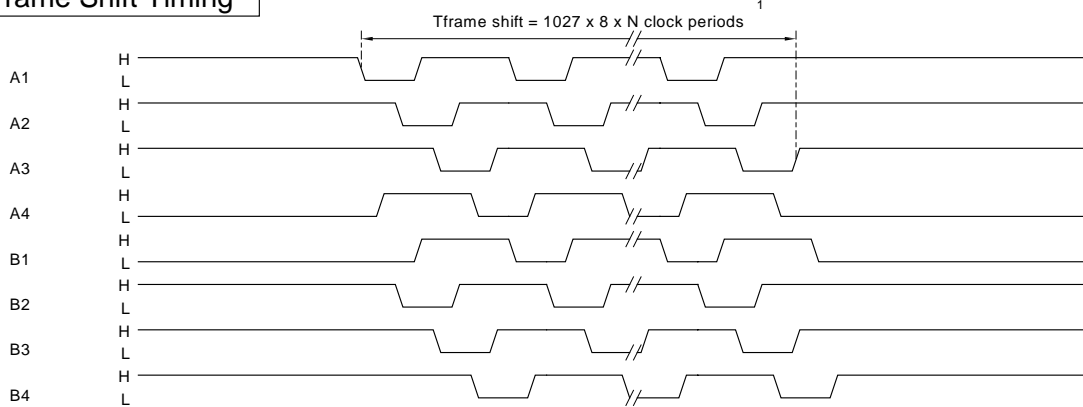

¹ 8 phases correspond with 2 line shifts

$$N = \frac{\text{Horizontal freq.}}{\text{Vertical freq.} \times 8}, \text{ for example: } \frac{18\text{MHz}}{450\text{kHz} \times 8} = 5$$

VD: Frame pulse
 CR: Charge Reset
 BLC: Black Level Clamp
 A1 to A4: Vertical image clocks

B1 to B4: Vertical storage clocks
 C1 to C3: Horizontal register clocks
 SSC: Start-Stop C-clacks
 SG: Summing gate
 RG: Reset gate

Figure 4 - Frame timing diagrams

Frame Transfer CCD Image Sensor

FTT1010-M

Line timing

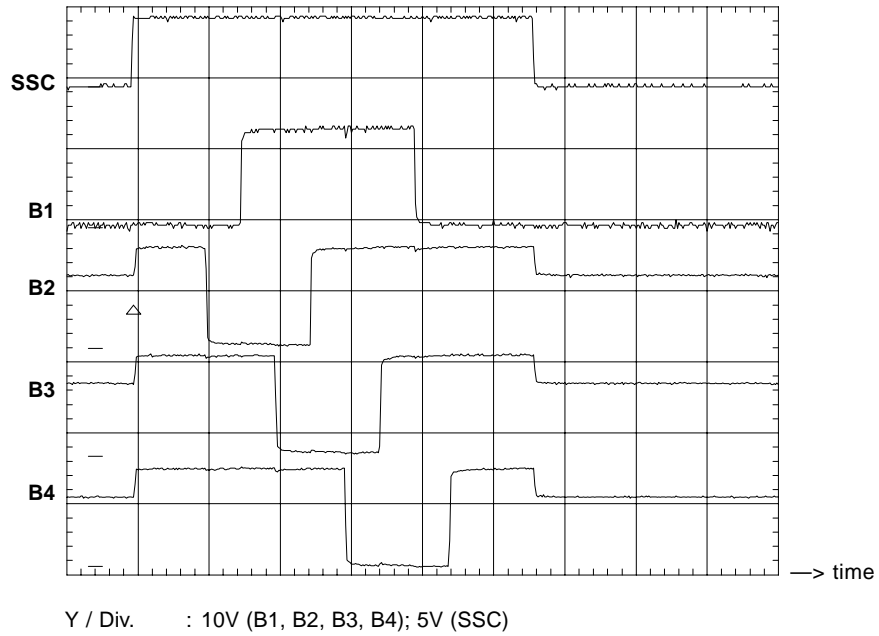

Figure 5 - Vertical readout

Pixel timing

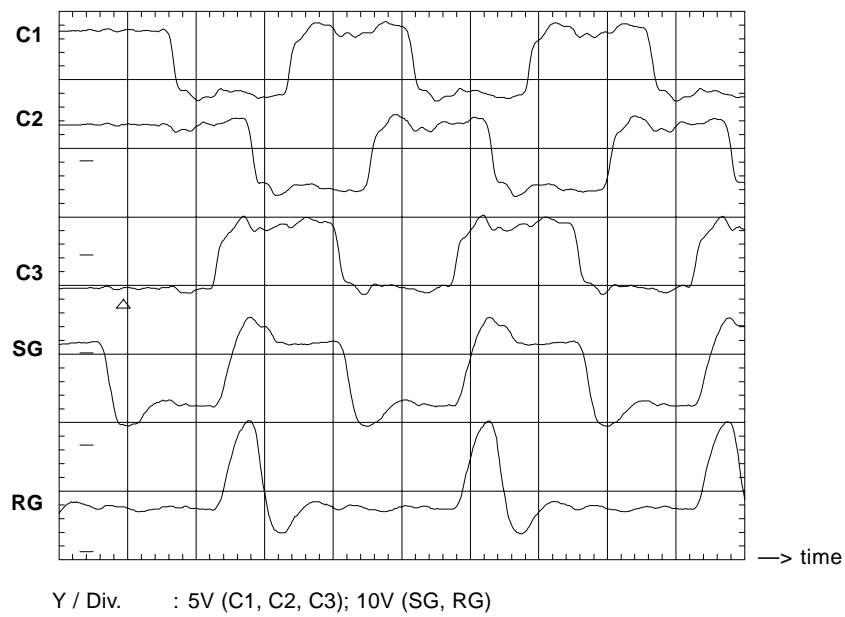

Figure 6 - Start horizontal readout

Frame Transfer CCD Image Sensor

FTT1010-M

Performance

The test conditions for the performance characteristics are as follows:

- All values are measured using typical operating conditions.
- VNS is adjusted as low as possible while maintaining proper Vertical Anti-Blooming.
- Sensor temperature = 60°C (333K).
- Horizontal transport frequency = 18MHz.
- Vertical transport frequency = 450kHz (unless specified otherwise).
- Integration time = 10ms (unless specified otherwise).
- The light source is a 3200K lamp with neutral density filters and a 1.7mm thick BG40 infrared cut-off filter. For Linear Operation measurements, a temperature conversion filter (Melles Griot type no. 03FCG261, -120 mired, thickness: 2.5mm) is applied.

LINEAR OPERATION	MIN.	TYPICAL	MAX.	UNIT
Linear dynamic range ¹	4200:1			
Charge Transfer Efficiency ² vertical		0.999995		
Charge Transfer Efficiency ² horizontal		0.999999		
Image lag			0	%
Smear ³		-39	0	dB
Resolution (MTF) @ 42 lp/mm	65			%
Responsivity	180	250		ke/lux-s
Quantum efficiency @ 530 nm	25	30		%
White Shading ⁴			2.5	%
Random Non-Uniformity (RNU) ⁵		0.3	5	%
VNS required for good Vertical Anti-Blooming (VAB)	18	24	28	V
Power dissipation at 15 frames/s		410		mW

¹ Linear dynamic range is defined as the ratio of Q_{in} to read-out noise (the latter reduced by Correlated Double Sampling).
² Charge Transfer Efficiency values are tested by evaluation and expressed as the value per gate transfer.
³ Smear is defined as the ratio of 10% of the vertical transport time to the integration time. It indicates how visible a spot of 10% of the image height would become.
⁴ White Shading is defined as the ratio of the one- σ value of the pixel output distribution expressed as a percentage of the mean value output (low pass image).
⁵ RNU is defined as the ratio of the one- σ value of the highpass image to the mean signal value at nominal light.

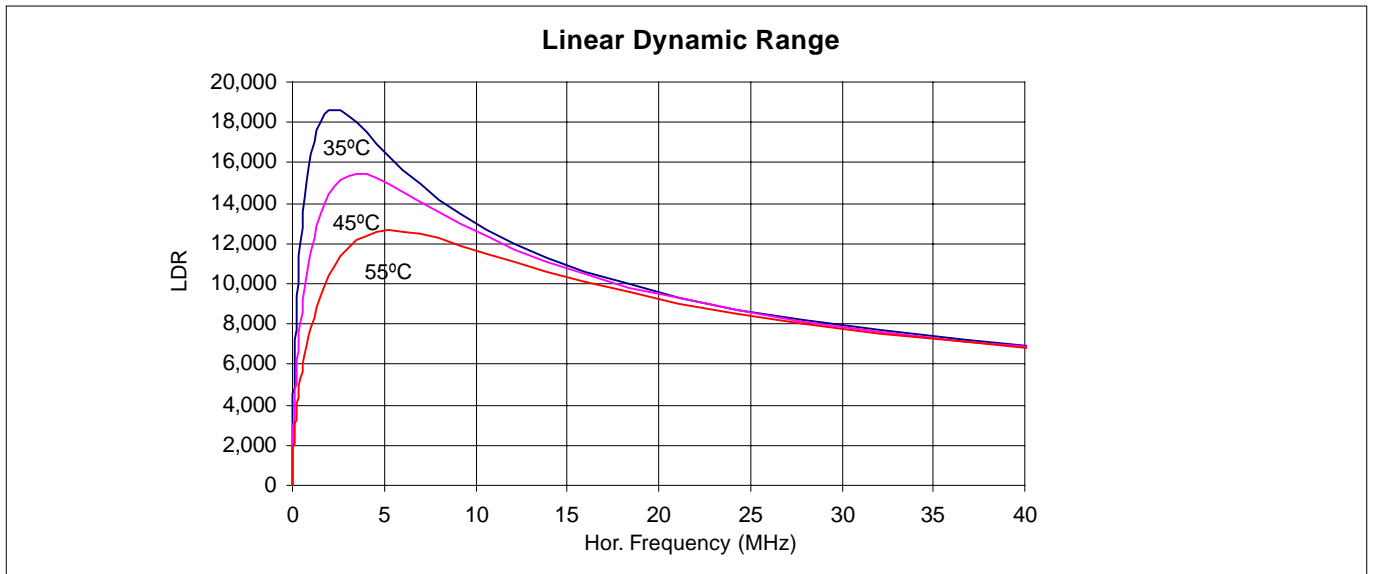

Figure 7 - Typical Linear dynamic range vs. horizontal read-out frequency and sensor temperature

Frame Transfer CCD Image Sensor

FTT1010-M

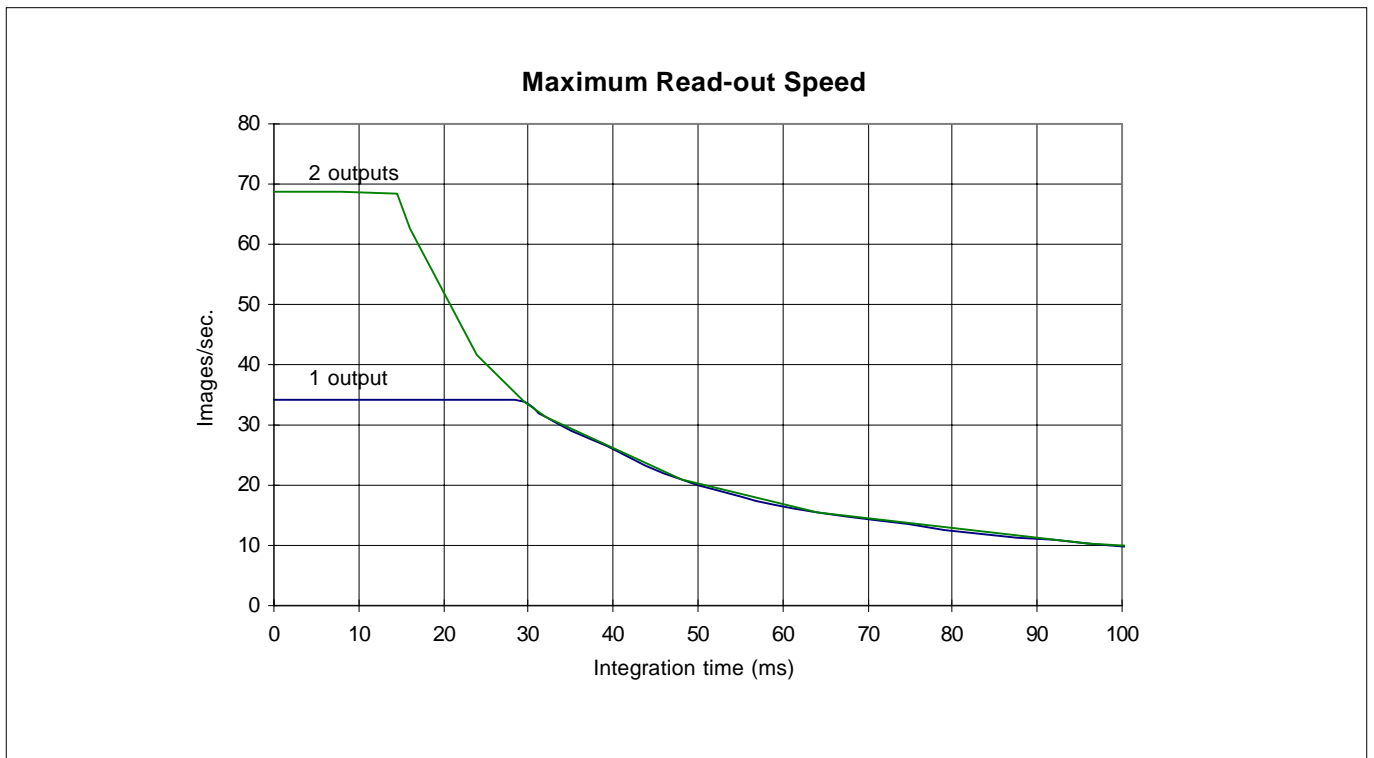

Figure 8 - Maximum number of images/second versus integration time

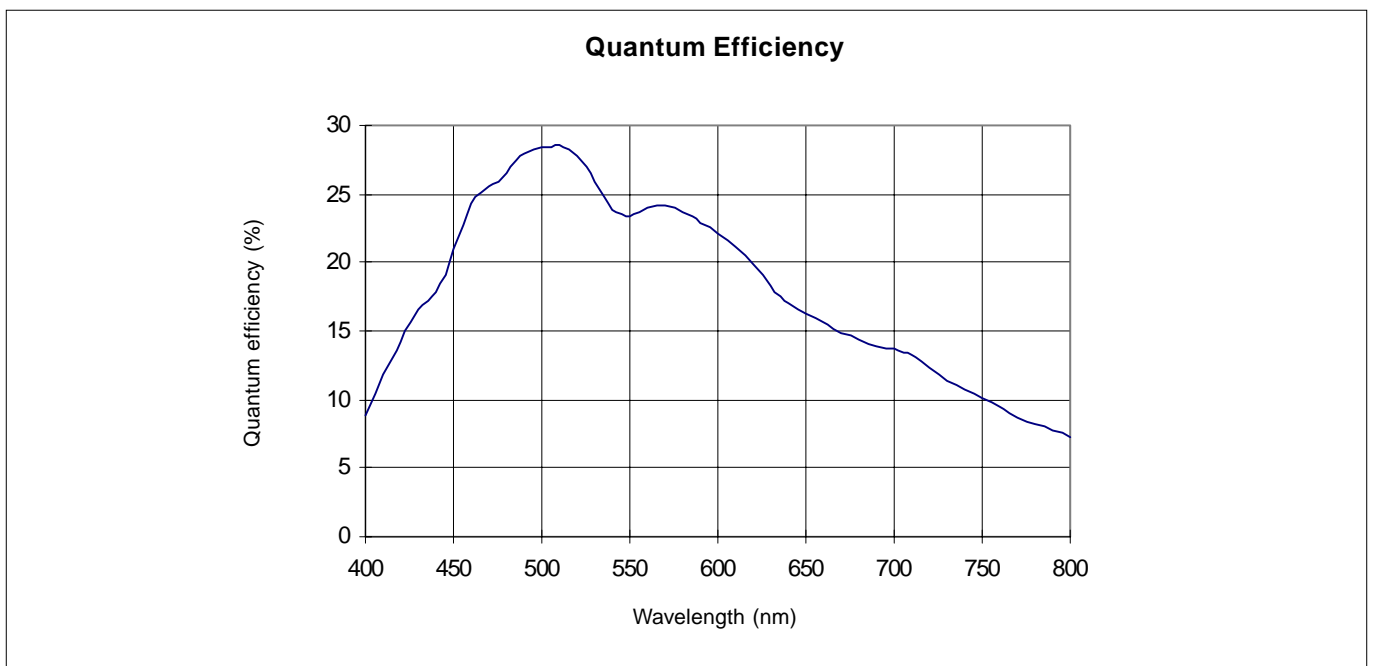

Figure 9 - Quantum efficiency versus wavelength

Frame Transfer CCD Image Sensor

FTT1010-M

LINEAR/SATURATION	MIN.	TYPICAL	MAX.	UNIT
Full-well capacity saturation level (Qmax) ¹	250	500	600	kel.
Full-well capacity shading (Qmax, shading) ²		10	50	%
Full-well capacity linear operation (Qlin) ³	200	350		kel.
Charge handling capacity ⁴		600		kel.
Overexposure ⁵ handling	100	200		x Qmax level

¹Qmax is determined from the lowpass filtered image.

²Qmax, shading is the maximum difference of the full-well charges of all pixels, relative to Qmax.

³The linear full-well capacity Qlin is calculated from linearity test (see dynamic range). The evaluation test guarantees 97% linearity.

⁴Charge handling capacity is the largest charge packet that can be transported through the register and read-out through the output buffer.

⁵Overexposure over entire area while maintaining good Vertical Anti-Blooming (VAB). It is tested by measuring the dark line.

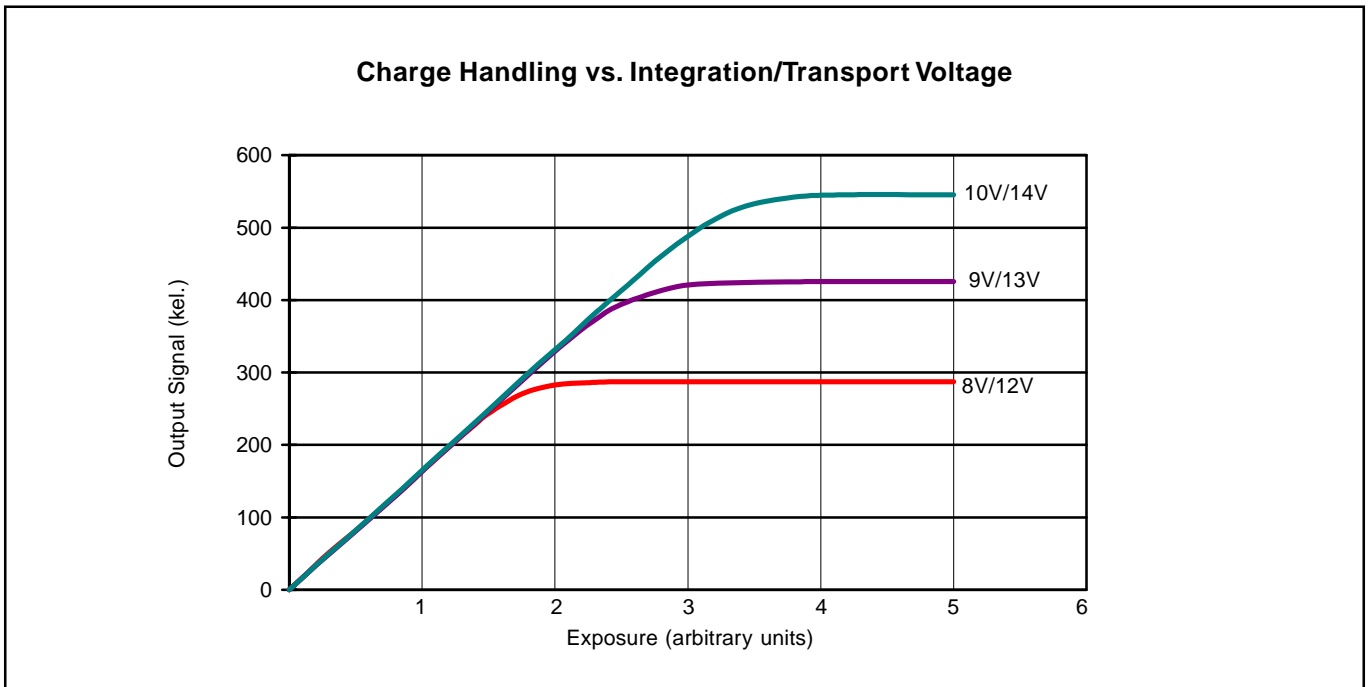

Figure 10 - Charge handling versus integration/transport voltage

Frame Transfer CCD Image Sensor

FTT1010-M

OUTPUT BUFFERS	MIN.	TYPICAL	MAX.	UNIT
Conversion factor	6	8	12	$\mu\text{V/el.}$
Mutual conversion factor matching (ΔACF) ¹		0	2	$\mu\text{V/el.}$
Supply current		4		mA
Bandwidth		110		MHz
Output impedance buffer ($R_{\text{load}} = 3.3\text{k}\Omega, C_{\text{load}} = 2\text{pF}$)		400		Ω

¹ Matching of the four outputs is specified as ΔACF with respect to reference measured at the operating point ($Q_{\text{lin}}/2$).

DARK CONDITION	MIN.	TYPICAL	MAX.	UNIT
Dark current level @ 30° C		20	30	pA/cm^2
Dark current level @ 60° C		0.3	0.6	nA/cm^2
Fixed Pattern Noise ¹ (FPN) @ 60° C		15	25	el.
RMS readout noise @ 9MHz bandwidth after CDS		25	30	el.

¹ FPN is the one- σ value of the highpass image.

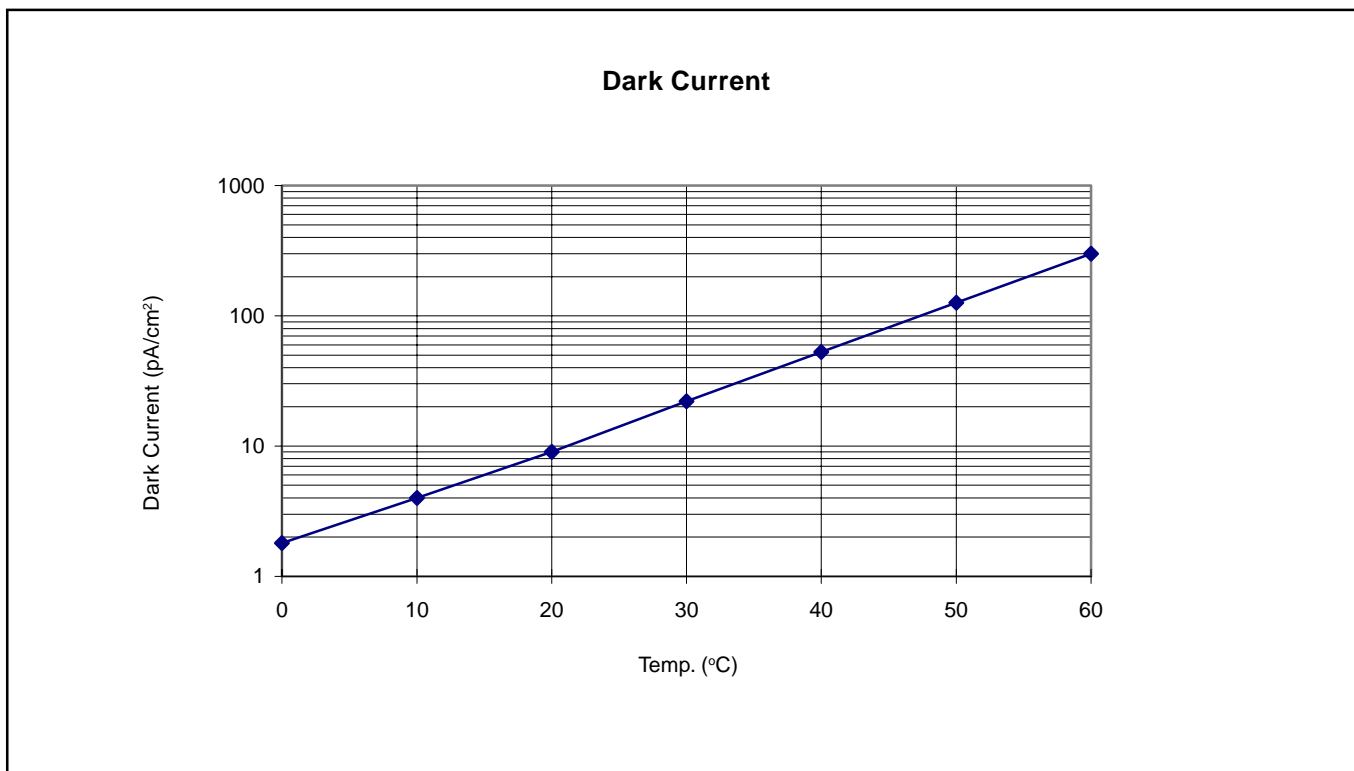

Figure 11 - Dark current versus temperature

Frame Transfer CCD Image Sensor

FTT1010-M

Application information

Current handling

One of the purposes of VPS is to drain the holes that are generated during exposure of the sensor to light. Free electrons are either transported to the VRD connection and, if excessive (from overexposure), free electrons are drained to VNS. No current should flow into any VPS connection of the sensor. During high overexposure a total current 10 to 15mA through all VPS connections together may be expected. The PNP emitter follower in the circuit diagram (figure 12) serves these current requirements.

VNS drains superfluous electrons as a result of overexposure. In other words, it only sinks current. During high overexposure a total current of 10 to 15mA through all VNS connections together may be expected. The NPN emitter follower in the circuit diagram meets these current requirements. The clamp circuit, consisting of the diode and electrolytic capacitor, enables the addition of a Charge Reset (CR) pulse on top of an otherwise stable VNS voltage. To protect the CCD, the current resulting from this pulse should be limited. This can be accomplished by designing a pulse generator with a rather high output impedance.

Decoupling of DC voltages

All DC voltages (not VNS, which has additional CR pulses as described above) should be decoupled with a 100nF decoupling capacitor. This capacitor must be mounted as close as possible to the sensor pin. Further noise reduction (by bandwidth limiting) is achieved by the resistors in the connections between the sensor and its voltage supplies. The electrons that build up the charge packets that will reach the floating diffusions only add up to a small current, which will flow through VRD. Therefore a large series resistor in the VRD connection may be used.

Outputs

To limit the on-chip power dissipation, the output buffers are designed with open source outputs. Outputs to be used should therefore be loaded with a current source or more simply with a resistance to GND. In order to prevent the output (which typically has an output impedance of about 400Ω) from bandwidth limitation as a result of capacitive loading, load the output with an emitter follower built from a high-frequency transistor. Mount the base of this transistor as close as possible to the sensor and keep the connection between the emitter and the next stage short.

The CCD output buffer can easily be destroyed by ESD. By using this emitter follower, this danger is suppressed; do NOT reintroduce this danger by measuring directly on the output pin of the sensor with an oscilloscope probe. Instead, measure on the output of the emitter follower. Slew rate limitation is avoided by avoiding a too-small quiescent current in the emitter follower; about 10mA should do the job. The collector of the emitter follower should be decoupled properly to suppress the Miller effect from the base-collector capacitance.

A CCD output load resistor of 3.3kΩ typically results in a bandwidth of 110MHz. The bandwidth can be enlarged to about 130MHz by using a resistor of 2.2kΩ instead, which, however, also enlarges the on-chip power dissipation.

Device protection

The output buffers of the FTT1010-M are likely to be damaged if VPS rises above SFD or RD at any time. This danger is most realistic during power-on or power-off of the camera. The RD voltage should always be lower than the SFD voltage.

Never exceed the maximum output current. This may damage the device permanently. The maximum output current should be limited to 10mA. Be especially aware that the output buffers of these image sensors are very sensitive to ESD damage.

Because of the fact that our CCDs are built on an n-type substrate, we are dealing with some parasitic npn transistors. To avoid activation of these transistors during switch-on and switch-off of the camera, we recommend the application diagram of figure 12.

Unused sections

To reduce power consumption the following steps can be taken. Connect unused output register pins (C1...C3, SG, OG) and unused SFS pins to zero Volts.

More information

Detailed application information is provided in the application note AN01 entitled '**Camera Electronics for the mK x nK CCD Image Sensor Family**'.

Frame Transfer CCD Image Sensor

FTT1010-M

Device Handling

An image sensor is a MOS device which can be destroyed by electrostatic discharge (ESD). Therefore, the device should be handled with care.

Always store the device with short-circuiting clamps or on conductive foam. Always switch off all electric signals when inserting or removing the sensor into or from a camera (the ESD protection in the CCD image sensor process is less effective than the ESD protection of standard CMOS circuits).

Being a high quality optical device, it is important that the cover glass remain undamaged. When handling the sensor, use fingercots.

When cleaning the glass we recommend using ethanol (or possibly water). Use of other liquids is strongly discouraged:

- if the cleaning liquid evaporates too quickly, rubbing is likely to cause ESD damage.
- the cover glass and its coating can be damaged by other liquids.

Rub the window carefully and slowly.

Dry rubbing of the window may cause electro-static charges or scratches which can destroy the device.

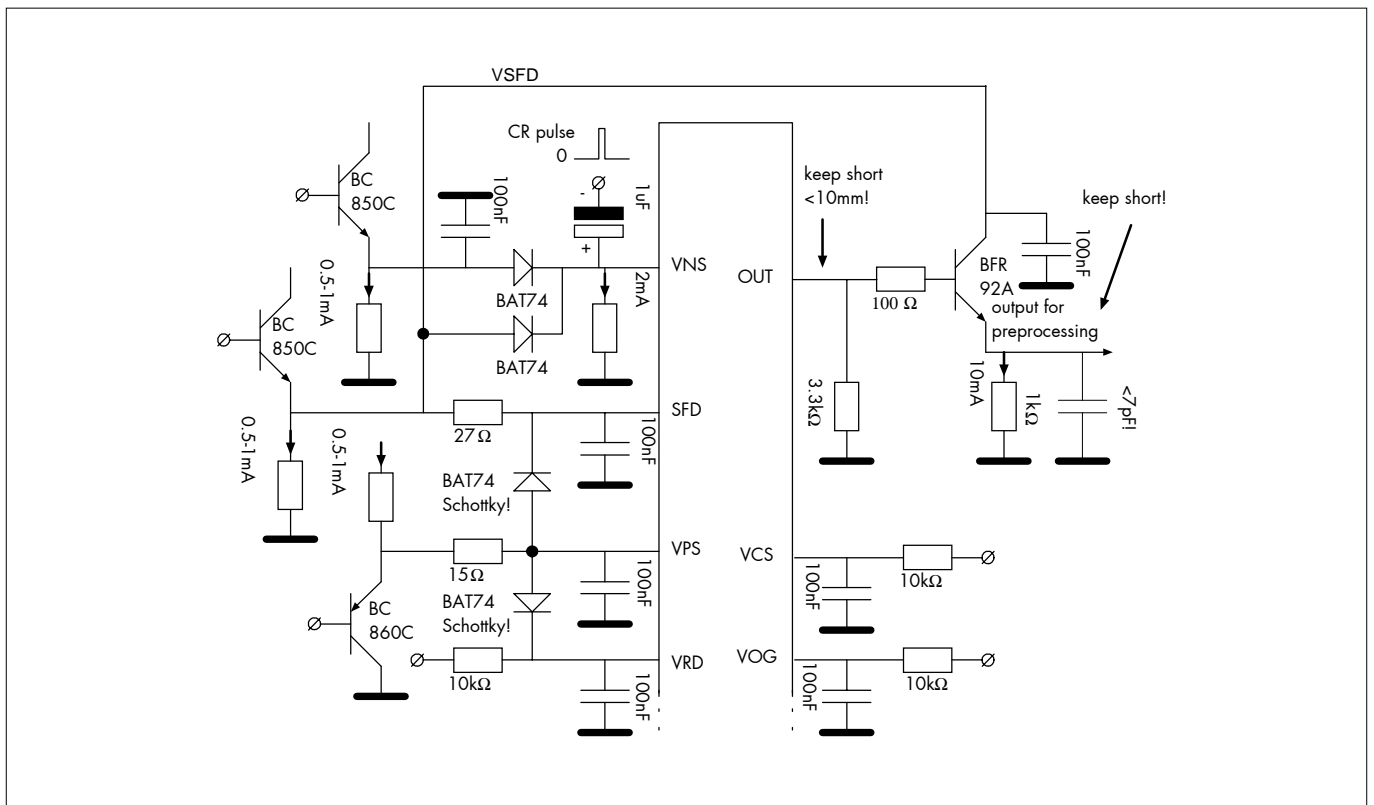

Figure 12 - Application diagram to protect the FTT1010-M

Frame Transfer CCD Image Sensor

FTT1010-M

Pin configuration

The FTT1010-M is mounted in a Pin Grid Array (PGA) package with 76 pins in a 15x13 grid of 40.00 x 40.00 mm². The position of pin A1 is marked with a gold dot on top of the package.

The clock phases of quadrant W are internally connected to X, and the clock phases of Y are connected to Z.

Symbol	Name	Pin # W	Pin # X	Pin # Y	Pin # Z
VNS	N substrate	A12	A3	J2	F11
VNS	N substrate	D11	B2	F3	H12
VNS	N substrate	E11	D3	-	J11
VNS	N substrate	E12	E2	-	-
VNS	N substrate	-	E3	-	-
VPS	P substrate	C11	C3	G3	G11
SFD	Source Follower Drain	A13	A1	J1	J13
SFS	Source Follower Source	A10	B5	J4	H9
VCS	Current Source	A11	A4	J3	J10
OG	Output Gate	B13	B1	H1	H13
RD	Reset Drain	B12	B3	H2	H11
A1	Image Clock (Phase 1)	-	-	F1	F13
A2	Image Clock (Phase 2)	-	-	G2	G12
A3	Image Clock (Phase 3)	-	-	F2	F12
A4	Image Clock (Phase 4)	-	-	G1	G13
B1	Storage Clock (Phase 1)	D13	D1	-	-
B2	Storage Clock (Phase 2)	C12	C2	-	-
B3	Storage Clock (Phase 3)	D12	D2	-	-
B4	Storage Clock (Phase 4)	C13	C1	-	-
C1	Register Clock (Phase 1)	B9	A6	H5	J8
C2	Register Clock (Phase 2)	B8	A7	H6	J7
C3	Register Clock (Phase 3)	A8	B6	J6	H8
SG	Summing Gate	B10	A2	H4	J12
RG	Reset Gate	A9	A5	J5	J9
OUT	Output	B11	B4	H3	H10
NC	Not connected	B7	-	H7	-

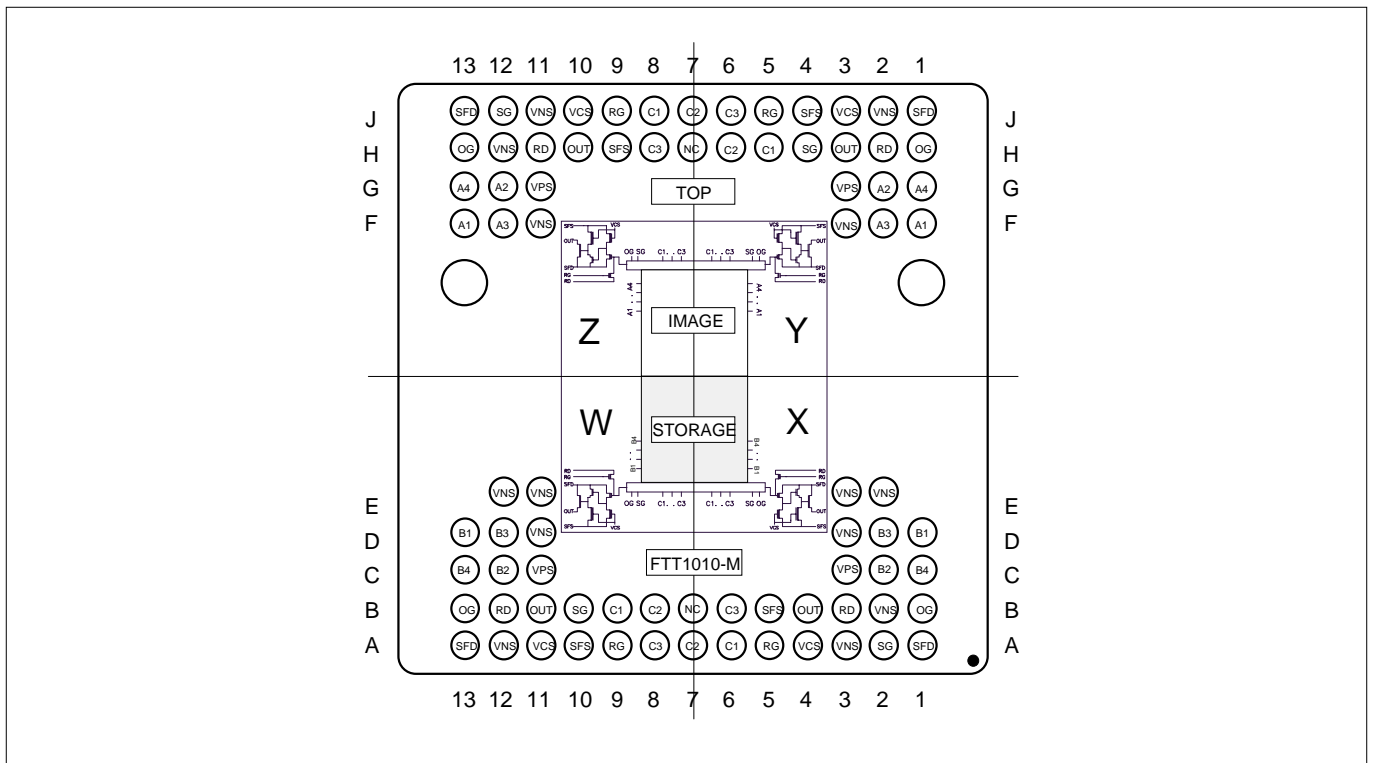

Figure 13 - FTT1010-M pin configuration (top view)

Frame Transfer CCD Image Sensor

FTT1010-M

Package information

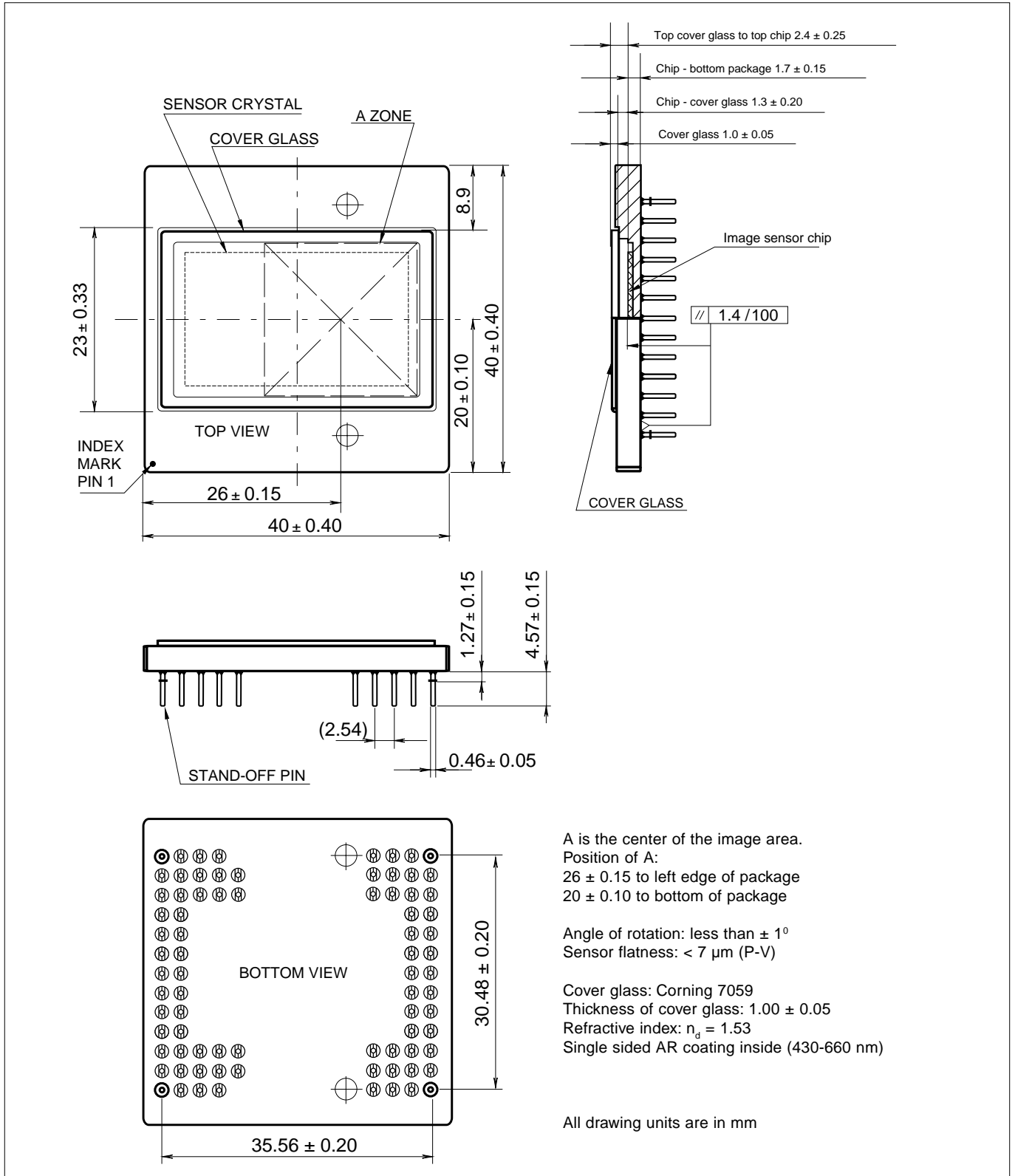

Figure 14 - Mechanical drawing of the PGA package of the FTT1010-M

Order codes

The sensors can be ordered using the following codes:

FTT1010-M sensors		
Description	Quality Grade	Order Code
FTT1010-M/TG	Test grade	9922 157 35031
FTT1010-M/EG	Economy grade	9922 157 35051
FTT1010-M/IG	Industrial grade	9922 157 35021
FTT1010-M/HG	High grade	9922 157 35011

You can contact the Image Sensors division of Philips Semiconductors at the following address:

Philips Semiconductors
Image Sensors
Internal Postbox WAG-05
Prof. Holstlaan 4
5656 AA Eindhoven
The Netherlands

phone +31 - 40 - 27 44 400
fax +31 - 40 - 27 44 090

www.semiconductors.philips.com/imagers/

Let's make things better.

Philips
Semiconductors



PHILIPS