

PowerMOS transistor

PHP3N20E

GENERAL DESCRIPTION

N-channel enhancement mode field-effect power transistor in a plastic envelope featuring high avalanche energy capability, stable blocking voltage, fast switching and high thermal cycling performance with low thermal resistance. Intended for use in Switched Mode Power Supplies (SMPS), motor control circuits and general purpose switching applications.

QUICK REFERENCE DATA

SYMBOL	PARAMETER	MAX.	UNIT
V_{DS}	Drain-source voltage	200	V
I_D	Drain current (DC)	3.5	A
P_{tot}	Total power dissipation	50	W
$R_{DS(ON)}$	Drain-source on-state resistance	1.5	Ω

PINNING - TO220AB

PIN	DESCRIPTION
1	gate
2	drain
3	source
tab	drain

PIN CONFIGURATION

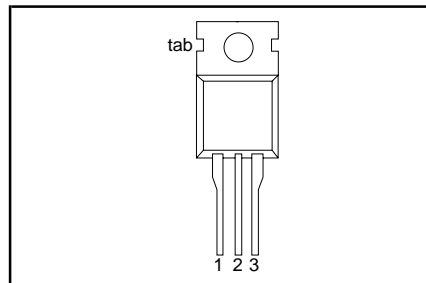

SYMBOL

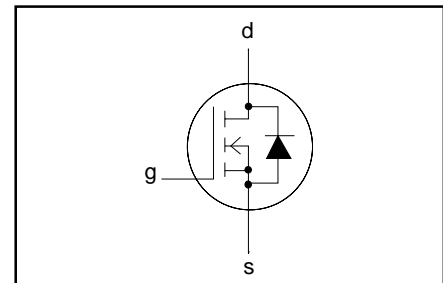

LIMITING VALUES

Limiting values in accordance with the Absolute Maximum System (IEC 134)

SYMBOL	PARAMETER	CONDITIONS	MIN.	MAX.	UNIT
I_D	Continuous drain current	$T_{mb} = 25\text{ }^\circ\text{C}; V_{GS} = 10\text{ V}$	-	3.5	A
I_{DM}	Pulsed drain current	$T_{mb} = 100\text{ }^\circ\text{C}; V_{GS} = 10\text{ V}$	-	2.5	A
P_D	Total dissipation	$T_{mb} = 25\text{ }^\circ\text{C}$	-	14	A
$\Delta P_D / \Delta T_{mb}$	Linear derating factor	$T_{mb} = 25\text{ }^\circ\text{C}$	-	50	W
V_{GS}	Gate-source voltage	$T_{mb} > 25\text{ }^\circ\text{C}$	-	0.33	W/K
E_{AS}	Single pulse avalanche energy	$V_{DD} \leq 50\text{ V};$ starting $T_j = 25\text{ }^\circ\text{C}; R_{GS} = 50\text{ }\Omega;$ $V_{GS} = 10\text{ V}$	-	± 30	V
I_{AS}	Peak avalanche current	$V_{DD} \leq 50\text{ V};$ starting $T_j = 25\text{ }^\circ\text{C}; R_{GS} = 50\text{ }\Omega;$ $V_{GS} = 10\text{ V}$	-	25	mJ
T_j, T_{stg}	Operating junction and storage temperature range		- 55	175	$^\circ\text{C}$

THERMAL RESISTANCES

SYMBOL	PARAMETER	CONDITIONS	MIN.	TYP.	MAX.	UNIT
$R_{th\ j-mb}$	Thermal resistance junction to mounting base		-	-	3	K/W
$R_{th\ j-a}$	Thermal resistance junction to ambient		-	60	-	K/W

PowerMOS transistor

PHP3N20E

ELECTRICAL CHARACTERISTICS $T_j = 25\text{ }^\circ\text{C}$ unless otherwise specified

SYMBOL	PARAMETER	CONDITIONS	MIN.	TYP.	MAX.	UNIT
$V_{(BR)DSS}$	Drain-source breakdown voltage	$V_{GS} = 0\text{ V}; I_D = 0.25\text{ mA}$	200	-	-	V
$\frac{\Delta V_{(BR)DSS}}{\Delta T_j}$	Drain-source breakdown voltage temperature coefficient	$V_{DS} = V_{GS}; I_D = 0.25\text{ mA}$	-	0.25	-	V/K
$R_{DS(ON)}$	Drain-source on resistance	$V_{GS} = 10\text{ V}; I_D = 2\text{ A}$	-	0.77	1.5	Ω
$V_{GS(TO)}$	Gate threshold voltage	$V_{DS} = V_{GS}; I_D = 0.25\text{ mA}$	2.0	3.0	4.0	V
g_{fs}	Forward transconductance	$V_{DS} = 50\text{ V}; I_D = 2\text{ A}$	0.8	3.0	-	S
I_{DSS}	Drain-source leakage current	$V_{DS} = 200\text{ V}; V_{GS} = 0\text{ V}$	-	0.1	25	μA
I_{GSS}	Gate-source leakage current	$V_{DS} = 160\text{ V}; V_{GS} = 0\text{ V}; T_j = 150\text{ }^\circ\text{C}$ $V_{GS} = \pm 30\text{ V}; V_{DS} = 0\text{ V}$	-	1	250	μA
$Q_{g(tot)}$	Total gate charge	$I_D = 3.3\text{ A}; V_{DD} = 160\text{ V}; V_{GS} = 10\text{ V}$	-	10	12	nC
Q_{gs}	Gate-source charge		-	1.1	2	nC
Q_{gd}	Gate-drain (Miller) charge		-	4.5	6	nC
$t_{d(on)}$	Turn-on delay time	$V_{DD} = 100\text{ V}; I_D = 3.3\text{ A};$ $R_G = 24\text{ }\Omega; R_D = 30\text{ }\Omega$	-	8	-	ns
t_r	Turn-on rise time		-	20	-	ns
$t_{d(off)}$	Turn-off delay time		-	30	-	ns
t_f	Turn-off fall time		-	25	-	ns
L_d	Internal drain inductance	Measured from contact screw on tab to centre of die	-	3.5	-	nH
L_d	Internal drain inductance	Measured from drain lead 6 mm from package to centre of die	-	4.5	-	nH
L_s	Internal source inductance	Measured from source lead 6 mm from package to source bond pad	-	7.5	-	nH
C_{iss}	Input capacitance	$V_{GS} = 0\text{ V}; V_{DS} = 25\text{ V}; f = 1\text{ MHz}$	-	200	-	pF
C_{oss}	Output capacitance		-	48	-	pF
C_{rss}	Feedback capacitance		-	20	-	pF

SOURCE-DRAIN DIODE RATINGS AND CHARACTERISTICS $T_j = 25\text{ }^\circ\text{C}$ unless otherwise specified

SYMBOL	PARAMETER	CONDITIONS	MIN.	TYP.	MAX.	UNIT
I_S	Continuous source current (body diode)	$T_{mb} = 25\text{ }^\circ\text{C}$	-	-	3.5	A
I_{SM}	Pulsed source current (body diode)	$T_{mb} = 25\text{ }^\circ\text{C}$	-	-	14	A
V_{SD}	Diode forward voltage	$I_S = 3.3\text{ A}; V_{GS} = 0\text{ V}$	-	-	1.5	V
t_{rr}	Reverse recovery time	$I_S = 3.3\text{ A}; V_{GS} = 0\text{ V};$ $di/dt = 100\text{ A}/\mu\text{s}$	-	90	-	ns
Q_{rr}	Reverse recovery charge		-	0.5	-	μC

PowerMOS transistor

PHP3N20E

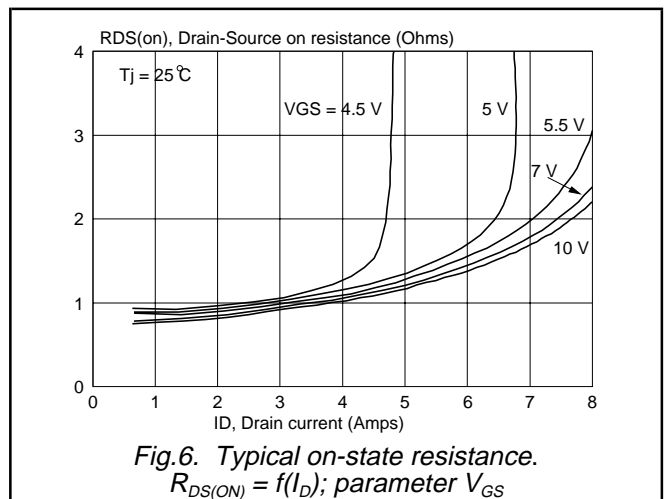
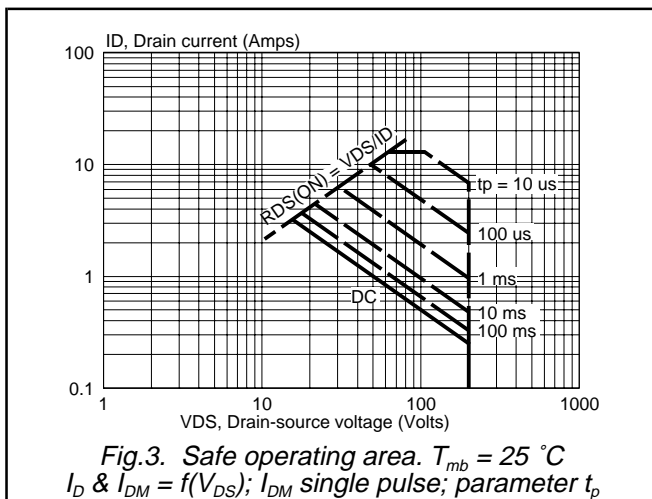
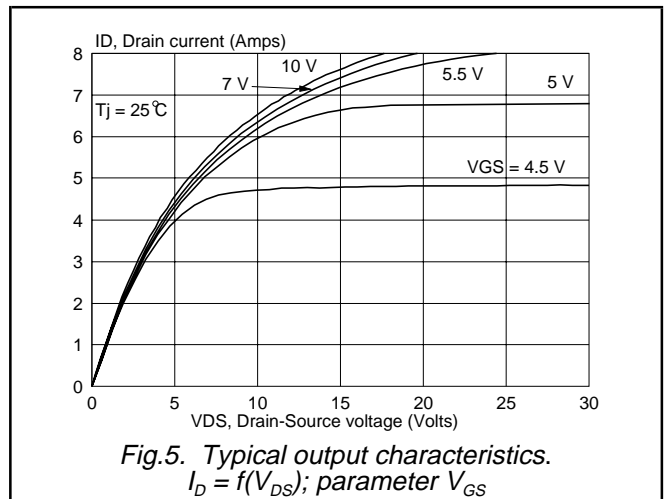
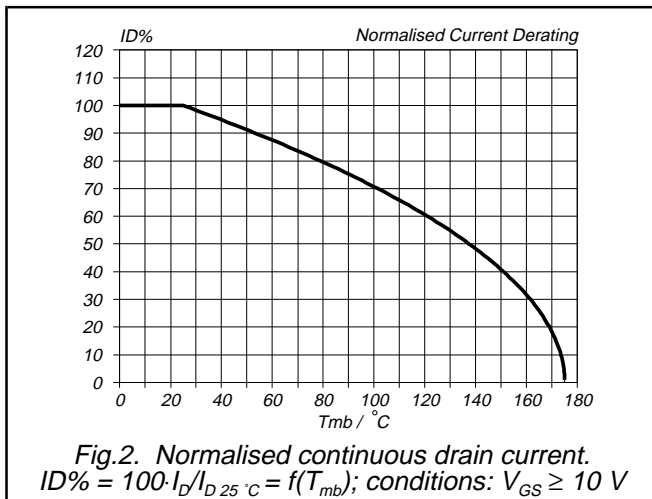
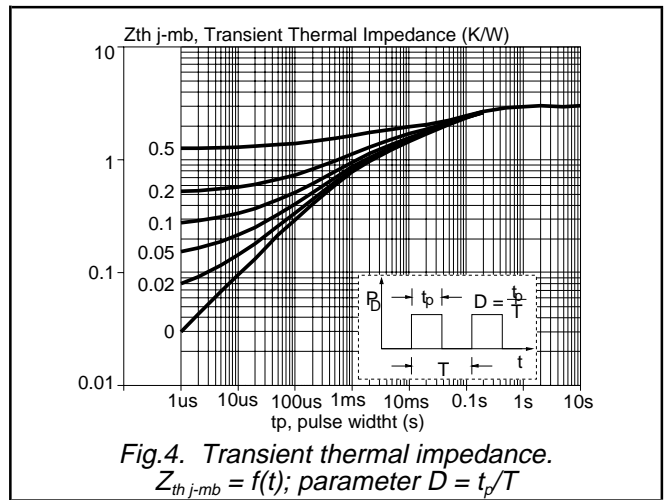
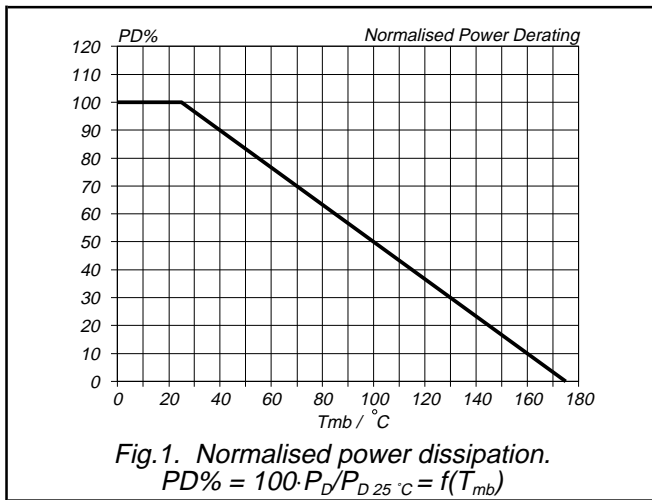

PowerMOS transistor

PHP3N20E

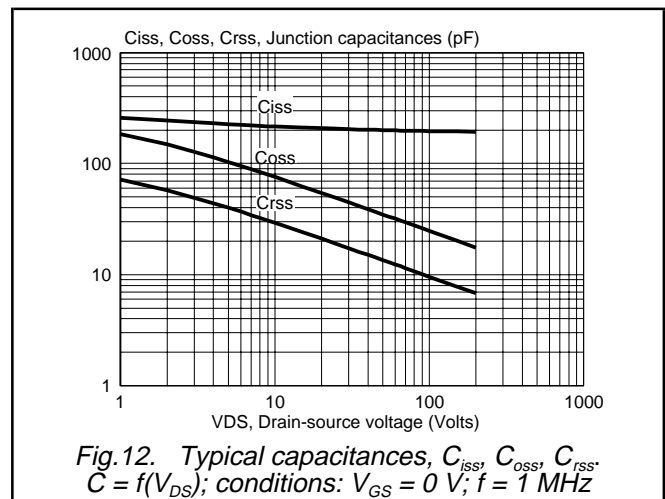
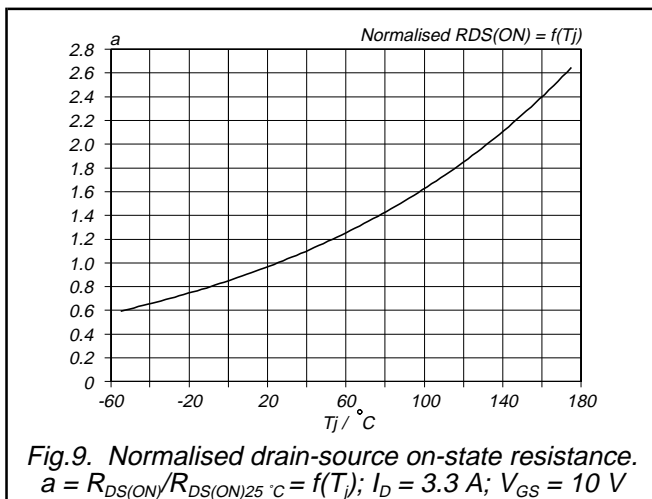
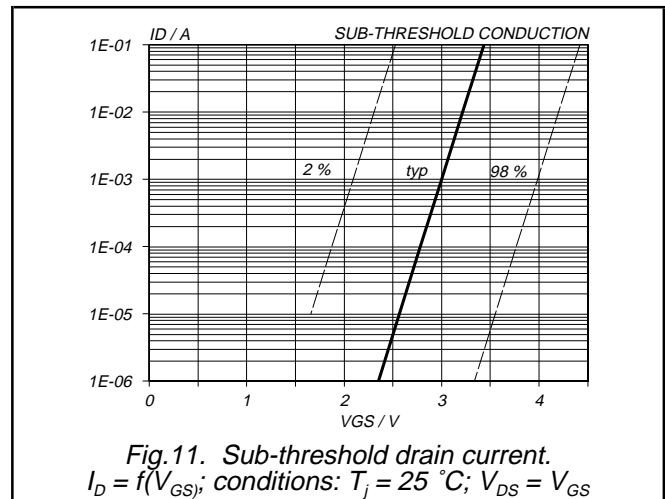
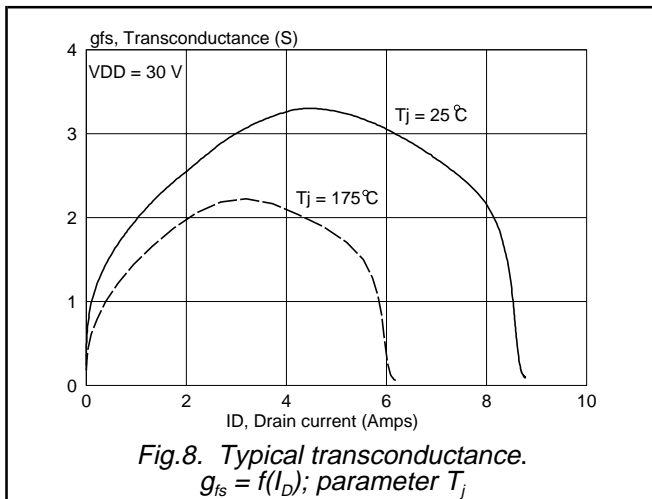
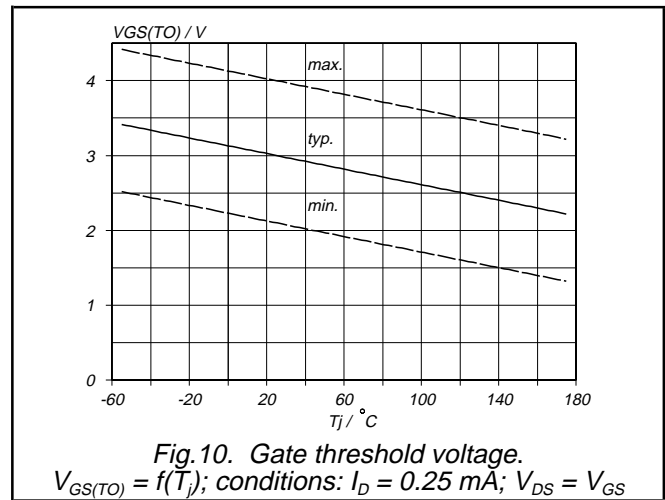
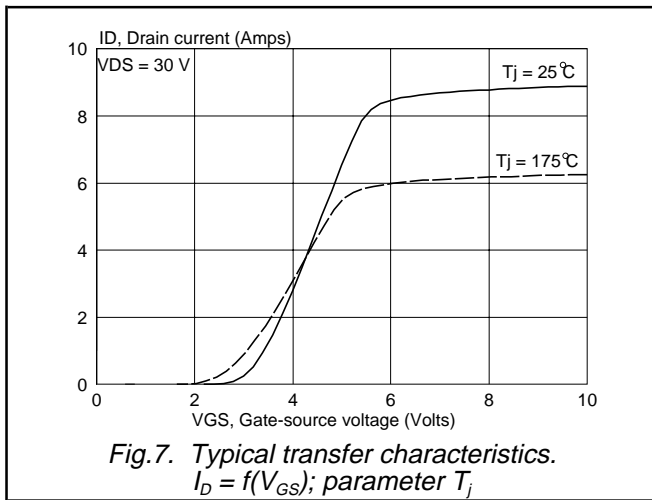

PowerMOS transistor

PHP3N20E

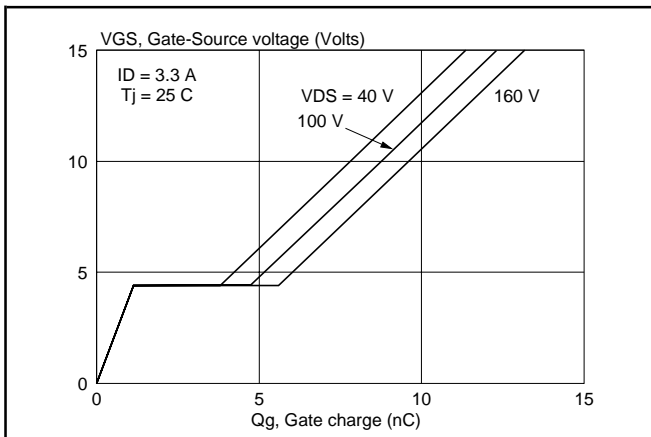

Fig.13. Typical turn-on gate-charge characteristics.
 $V_{GS} = f(Q_G)$; parameter V_{DS}

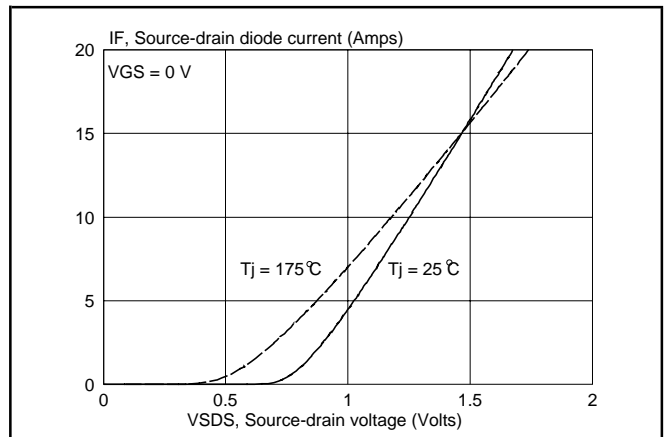

Fig.16. Source-Drain diode characteristic.
 $I_F = f(V_{SDS})$; parameter T_j

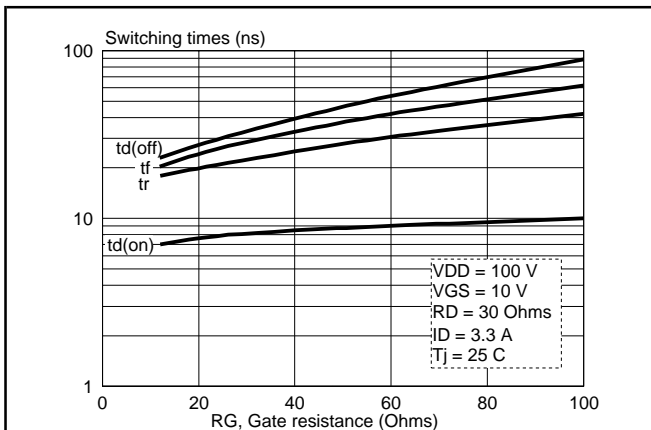

Fig.14. Typical switching times.
 $t_{d(on)}, t_r, t_{d(off)}, t_f = f(R_G)$

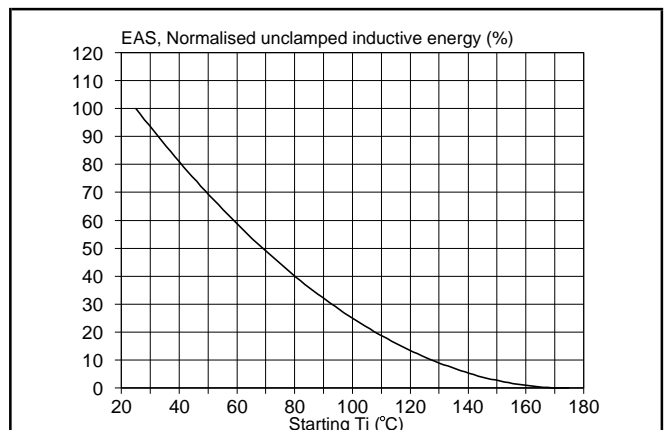

Fig.17. Normalised unclamped inductive energy.
 $E_{AS} \% = f(T_j)$

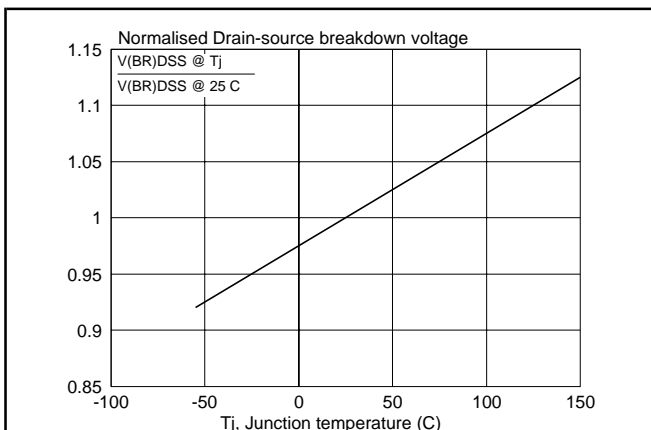

Fig.15. Normalised drain-source breakdown voltage.
 $V_{(BR)DSS} / V_{(BR)DSS 25 C} = f(T_j)$

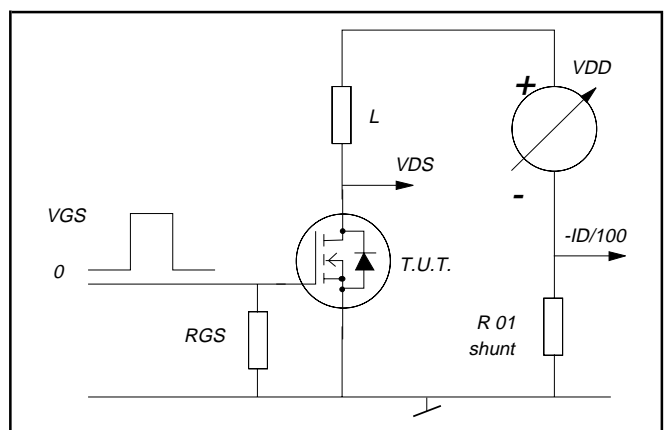

Fig.18. Unclamped inductive test circuit.
 $E_{AS} = 0.5 \cdot L I_D^2 \cdot V_{(BR)DSS} / (V_{(BR)DSS} - V_{DD})$

MECHANICAL DATA

Dimensions in mm

Net Mass: 2 g

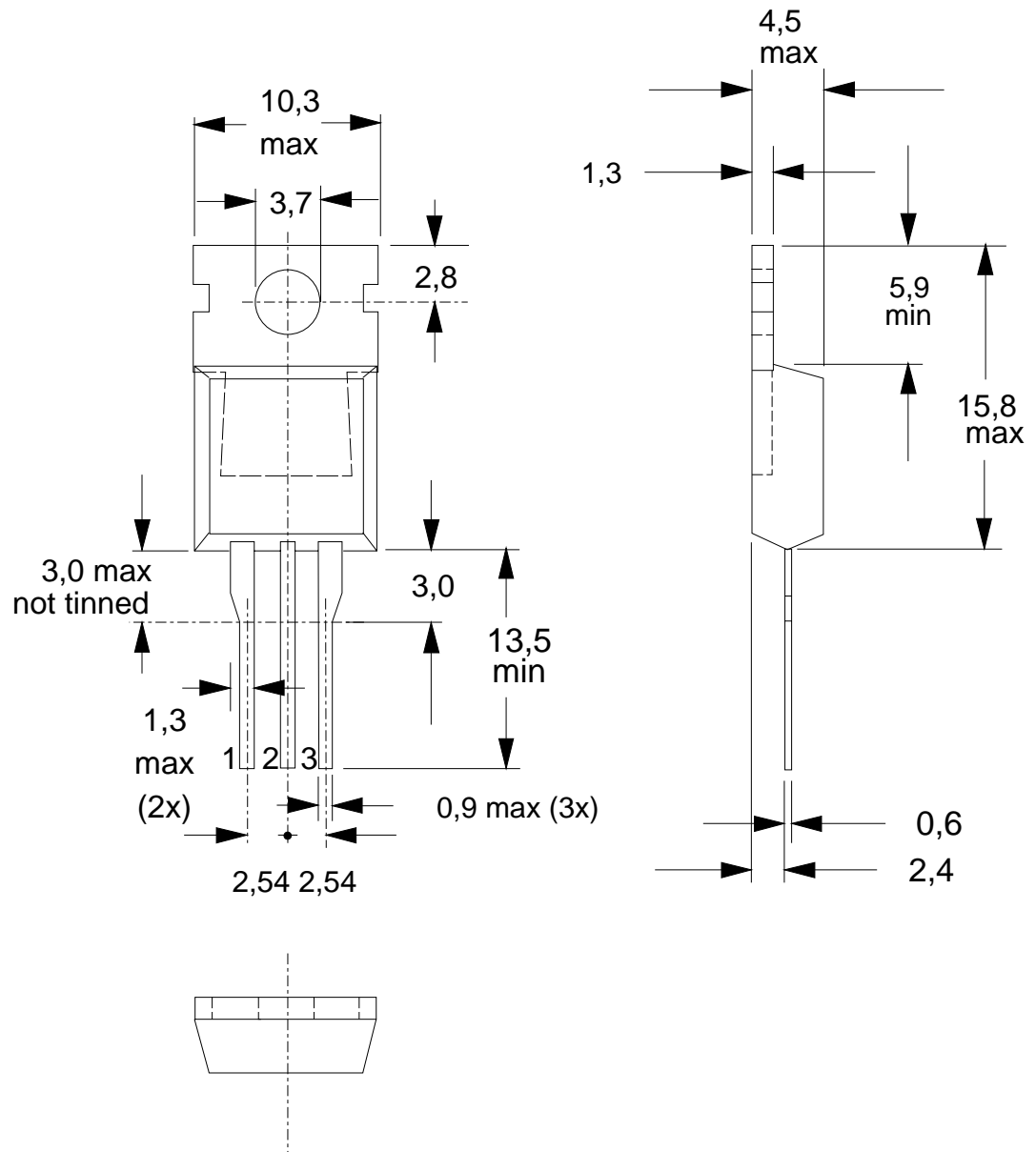

Fig.19. TO220AB; pin 2 connected to mounting base.

Notes

1. Observe the general handling precautions for electrostatic-discharge sensitive devices (ESDs) to prevent damage to MOS gate oxide.
2. Refer to mounting instructions for TO220 envelopes.
3. Epoxy meets UL94 V0 at 1/8".

PowerMOS transistor

PHP3N20E

DEFINITIONS

Data sheet status	
Objective specification	This data sheet contains target or goal specifications for product development.
Preliminary specification	This data sheet contains preliminary data; supplementary data may be published later.
Product specification	This data sheet contains final product specifications.
Limiting values	
Limiting values are given in accordance with the Absolute Maximum Rating System (IEC 134). Stress above one or more of the limiting values may cause permanent damage to the device. These are stress ratings only and operation of the device at these or at any other conditions above those given in the Characteristics sections of this specification is not implied. Exposure to limiting values for extended periods may affect device reliability.	
Application information	
Where application information is given, it is advisory and does not form part of the specification.	
© Philips Electronics N.V. 1997	
All rights are reserved. Reproduction in whole or in part is prohibited without the prior written consent of the copyright owner.	
The information presented in this document does not form part of any quotation or contract, it is believed to be accurate and reliable and may be changed without notice. No liability will be accepted by the publisher for any consequence of its use. Publication thereof does not convey nor imply any license under patent or other industrial or intellectual property rights.	

LIFE SUPPORT APPLICATIONS

These products are not designed for use in life support appliances, devices or systems where malfunction of these products can be reasonably expected to result in personal injury. Philips customers using or selling these products for use in such applications do so at their own risk and agree to fully indemnify Philips for any damages resulting from such improper use or sale.