

DATA SHEET

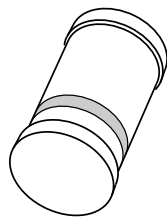

BYD37 series Fast soft-recovery controlled avalanche rectifiers

Product specification
Supersedes data of April 1992
File under Discrete Semiconductors, SC01

1996 Jun 05

Fast soft-recovery controlled avalanche rectifiers

BYD37 series

FEATURES

- Glass passivated
- High maximum operating temperature
- Low leakage current
- Excellent stability
- Guaranteed avalanche energy absorption capability
- Smallest surface mount rectifier outline
- Shipped in 8 mm embossed tape.

DESCRIPTION

Cavity free cylindrical glass package through Implotec™(1) technology. This package is hermetically sealed

and fatigue free as coefficients of expansion of all used parts are matched.

(1) Implotec is a trademark of Philips.

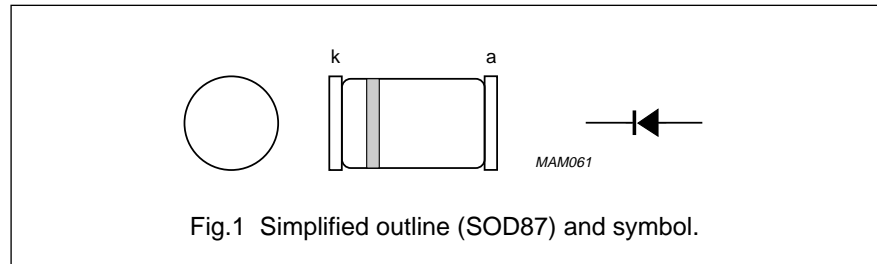

Fig.1 Simplified outline (SOD87) and symbol.

LIMITING VALUES

In accordance with the Absolute Maximum Rating System (IEC 134).

SYMBOL	PARAMETER	CONDITIONS	MIN.	MAX.	UNIT
V _{RRM}	repetitive peak reverse voltage				
	BYD37D		–	200	V
	BYD37G		–	400	V
	BYD37J		–	600	V
	BYD37K BYD37M		–	800 1000	V V
V _R	continuous reverse voltage				
	BYD37D		–	200	V
	BYD37G		–	400	V
	BYD37J		–	600	V
	BYD37K BYD37M		–	800 1000	V V
I _{F(AV)}	average forward current	T _{tp} = 105 °C; see Fig.2; averaged over any 20 ms period; see also Fig.6	–	1.5	A
I _{F(AV)}	average forward current	T _{amb} = 60 °C; PCB mounting (see Fig.11); see Fig.3; averaged over any 20 ms period; see also Fig.6	–	0.6	A
I _{FRM}	repetitive peak forward current	T _{tp} = 105 °C; see Fig.4	–	13	A
		T _{amb} = 60 °C; see Fig.5	–	5.5	A
I _{FSM}	non-repetitive peak forward current	t = 10 ms half sine wave; T _j = T _{jmax} prior to surge; V _R = V _{RRMmax}	–	20	A
E _{RSM}	non-repetitive peak reverse avalanche energy	L = 120 mH; T _j = T _{jmax} prior to surge; inductive load switched off			
	BYD37D to J BYD37K and M		–	10 7	mJ mJ

Fast soft-recovery controlled avalanche rectifiers

BYD37 series

SYMBOL	PARAMETER	CONDITIONS	MIN.	MAX.	UNIT
T_{stg}	storage temperature		-65	+175	°C
T_j	junction temperature	see Fig.7	-65	+175	°C

ELECTRICAL CHARACTERISTICS

$T_j = 25\text{ °C}$ unless otherwise specified.

SYMBOL	PARAMETER	CONDITIONS	MIN.	TYP.	MAX.	UNIT	
V_F	forward voltage	$I_F = 1\text{ A}$; $T_j = T_{j\text{ max}}$; see Fig.8	-	-	1.1	V	
		$I_F = 1\text{ A}$; see Fig.8	-	-	1.3	V	
$V_{(BR)R}$	reverse avalanche breakdown voltage	$I_R = 0.1\text{ mA}$					
			BYD37D	300	-	-	V
			BYD37G	500	-	-	V
			BYD37J	700	-	-	V
			BYD37K	900	-	-	V
BYD37M	1100	-	-	V			
I_R	reverse current	$V_R = V_{RRM\text{ max}}$; see Fig.9	-	-	1	μA	
		$V_R = V_{RRM\text{ max}}$; $T_j = 165\text{ °C}$; see Fig.9	-	-	100	μA	
t_{rr}	reverse recovery time	when switched from $I_F = 0.5\text{ A}$ to $I_R = 1\text{ A}$; measured at $I_R = 0.25\text{ A}$; see Fig.12			250	ns	
					300	ns	
C_d	diode capacitance	$f = 1\text{ MHz}$; $V_R = 0\text{ V}$; see Fig.10	-	20	-	pF	
$\left \frac{dI_R}{dt} \right $	maximum slope of reverse recovery current	when switched from $I_F = 1\text{ A}$ to $V_R \geq 30\text{ V}$ and $dI_F/dt = -1\text{ A}/\mu\text{s}$; see Fig.13			6	A/μs	
					5	A/μs	

THERMAL CHARACTERISTICS

SYMBOL	PARAMETER	CONDITIONS	VALUE	UNIT
$R_{th\ j\text{-tp}}$	thermal resistance from junction to tie-point		30	K/W
$R_{th\ j\text{-a}}$	thermal resistance from junction to ambient	note 1	150	K/W

Note

1. Device mounted on an epoxy-glass printed-circuit board, 1.5 mm thick; thickness of Cu-layer $\geq 40\text{ }\mu\text{m}$, see Fig.11.
For more information please refer to the 'General Part of Handbook SC01'.

Fast soft-recovery
controlled avalanche rectifiers

BYD37 series

GRAPHICAL DATA

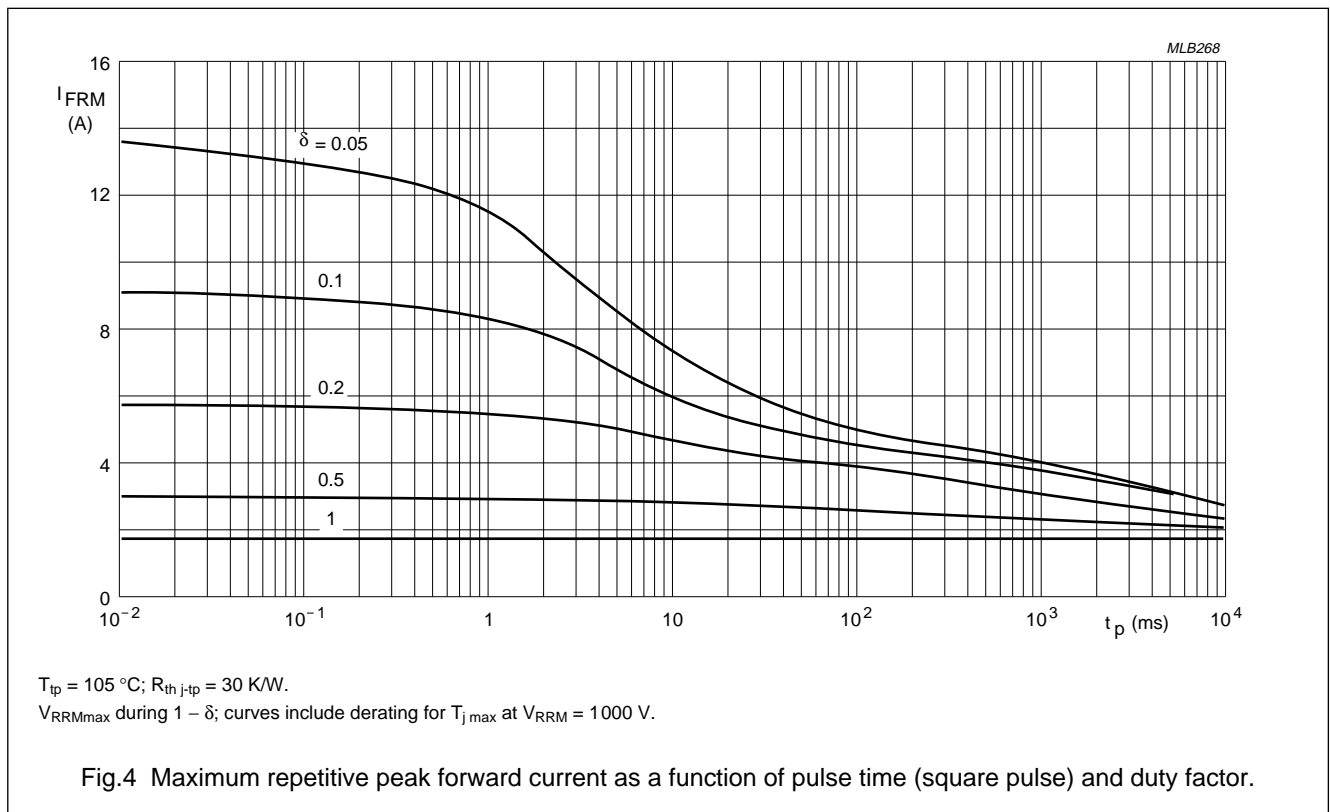
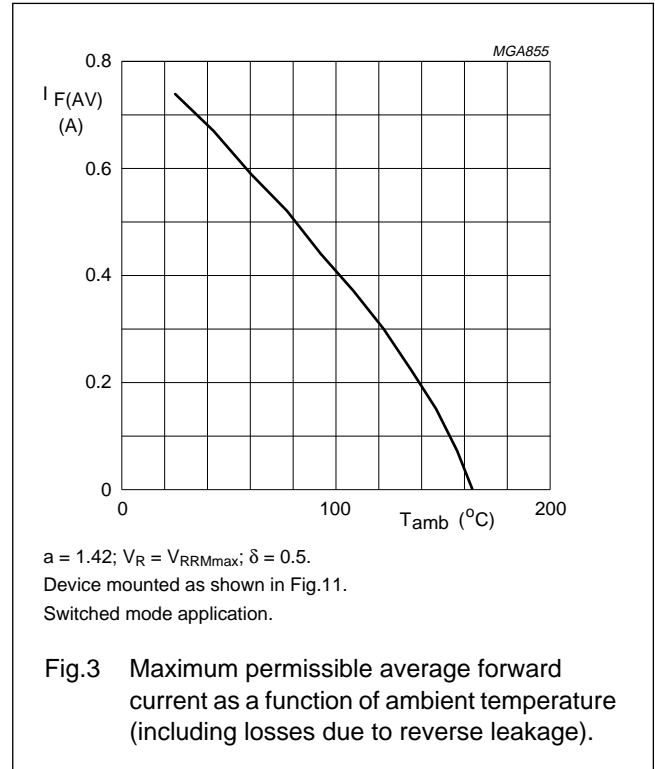
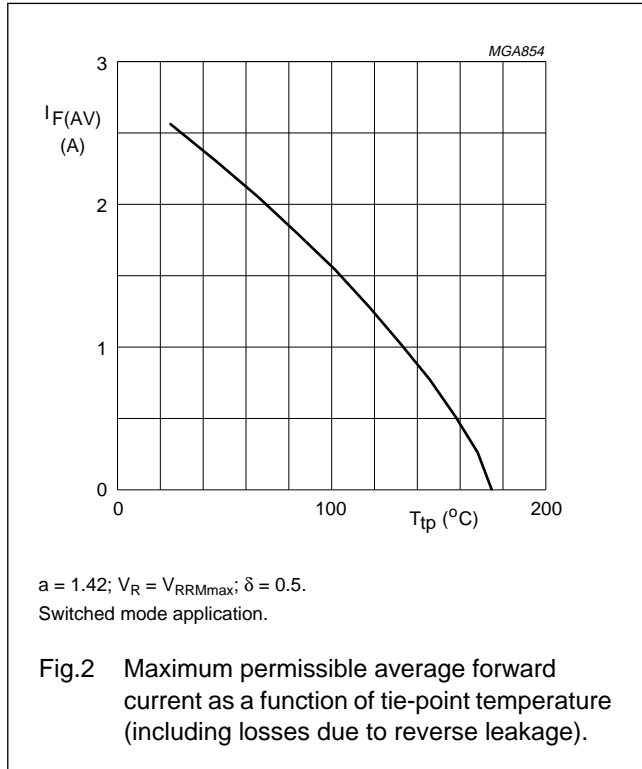

Fast soft-recovery
controlled avalanche rectifiers

BYD37 series

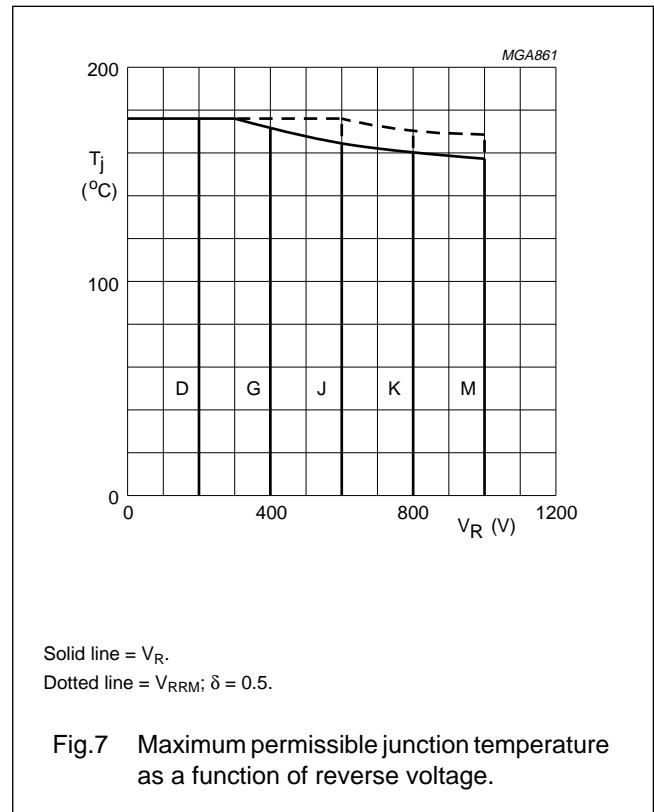
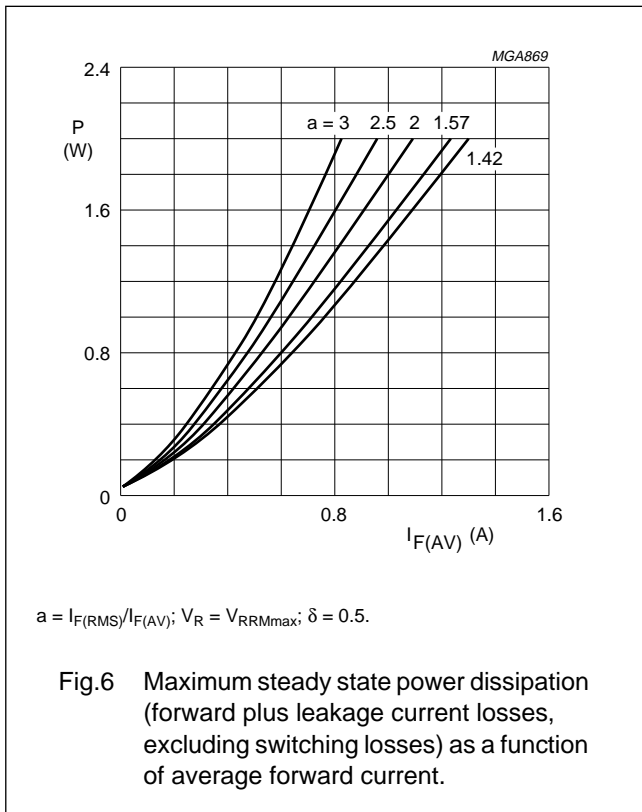
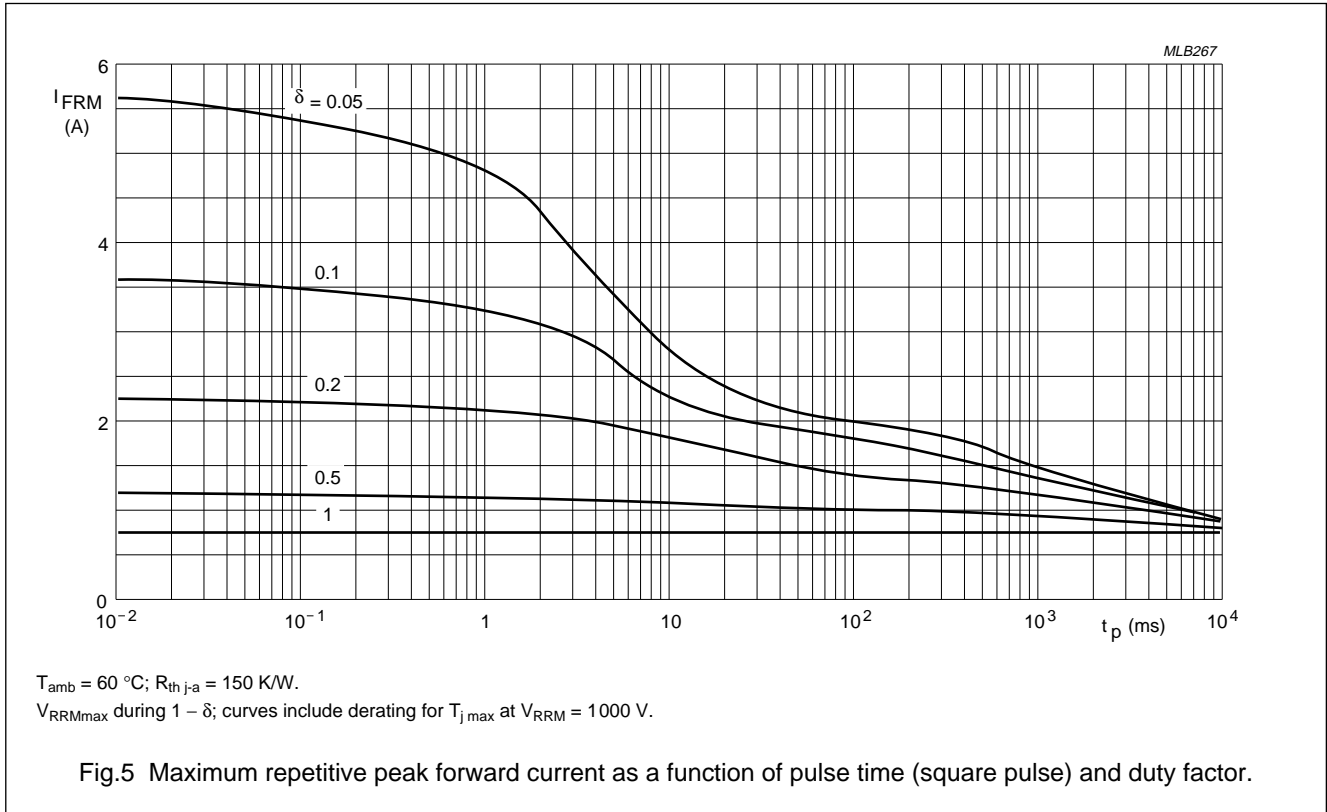

Fast soft-recovery
controlled avalanche rectifiers

BYD37 series

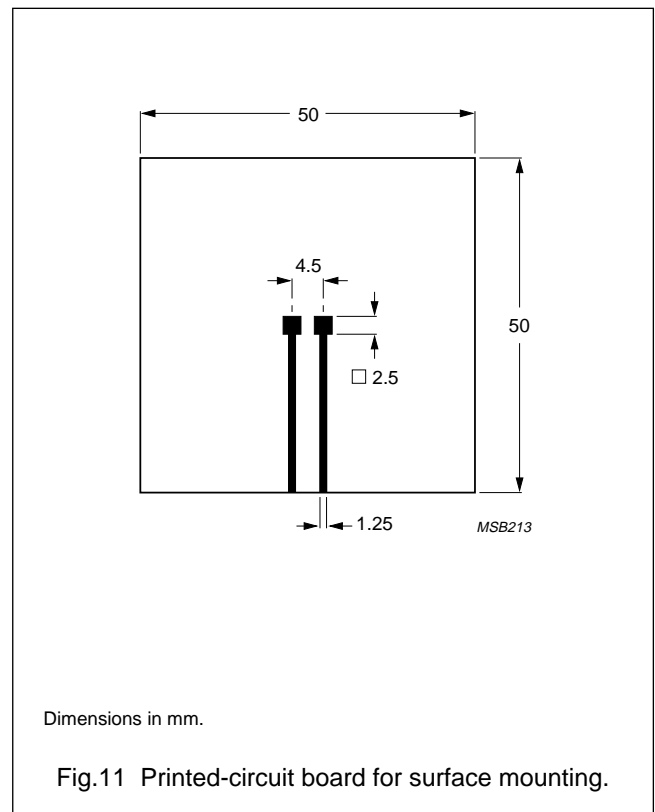
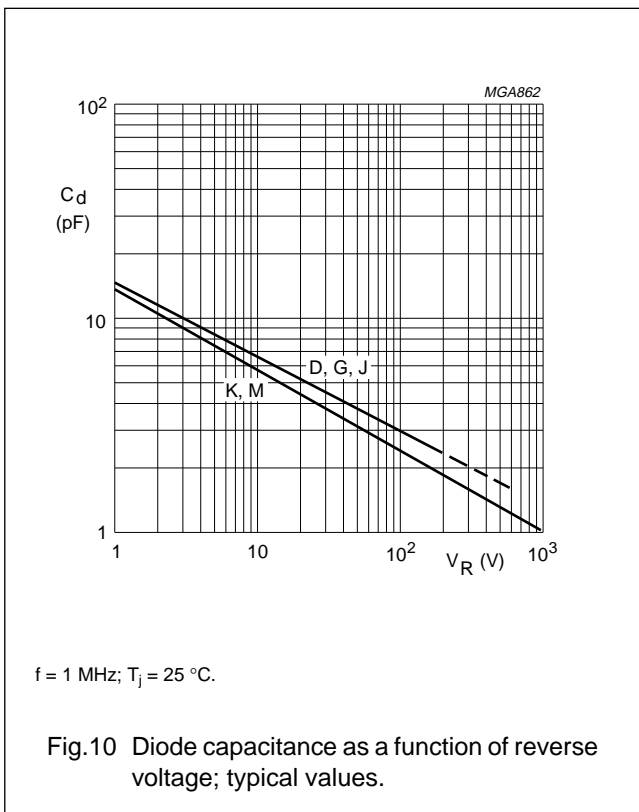
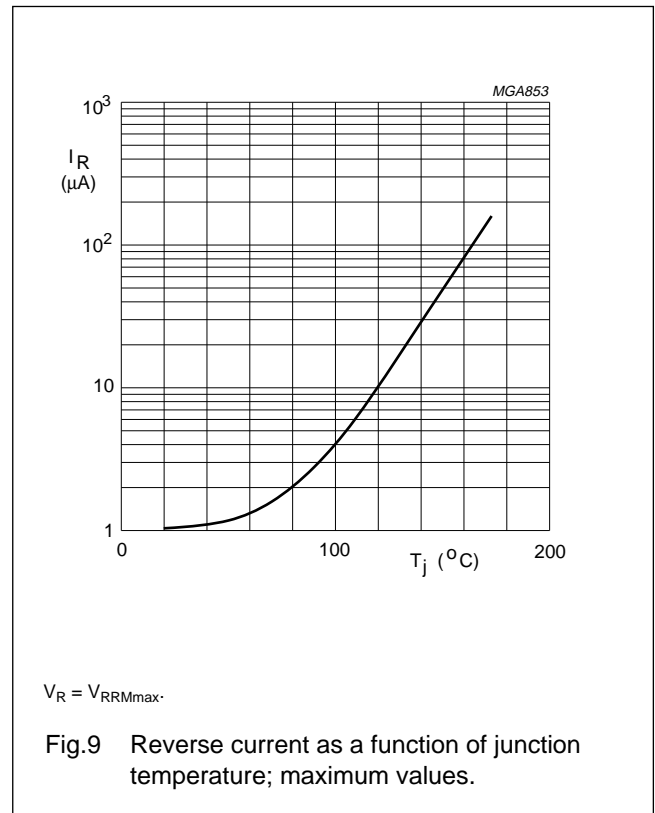
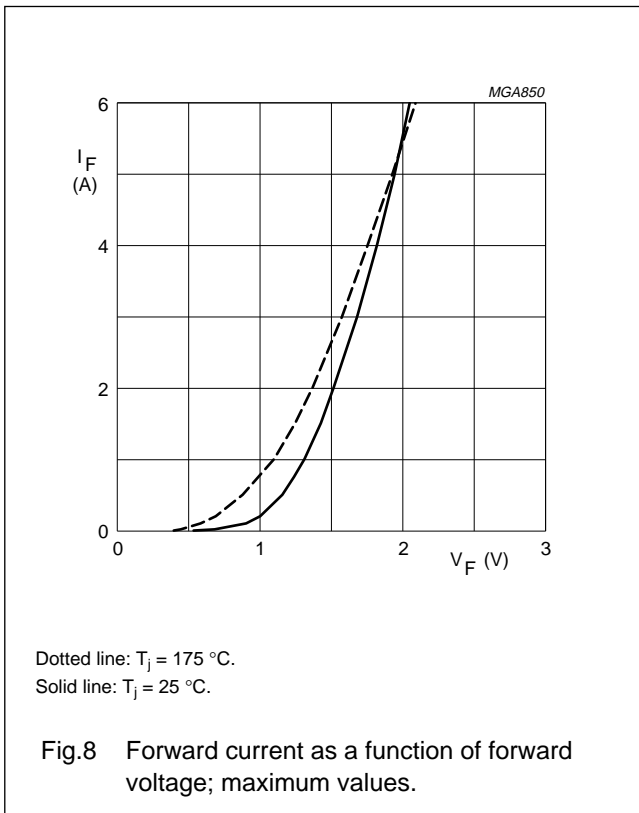

Fast soft-recovery
controlled avalanche rectifiers

BYD37 series

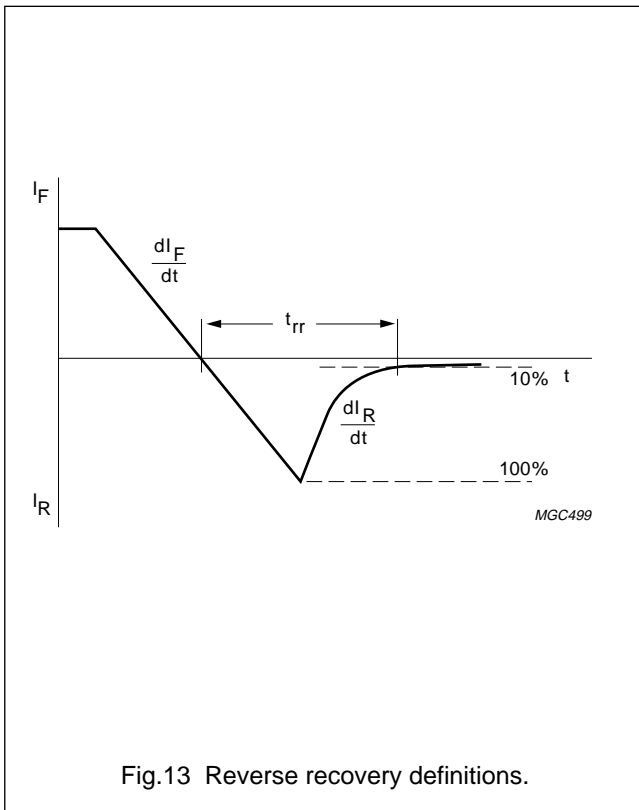
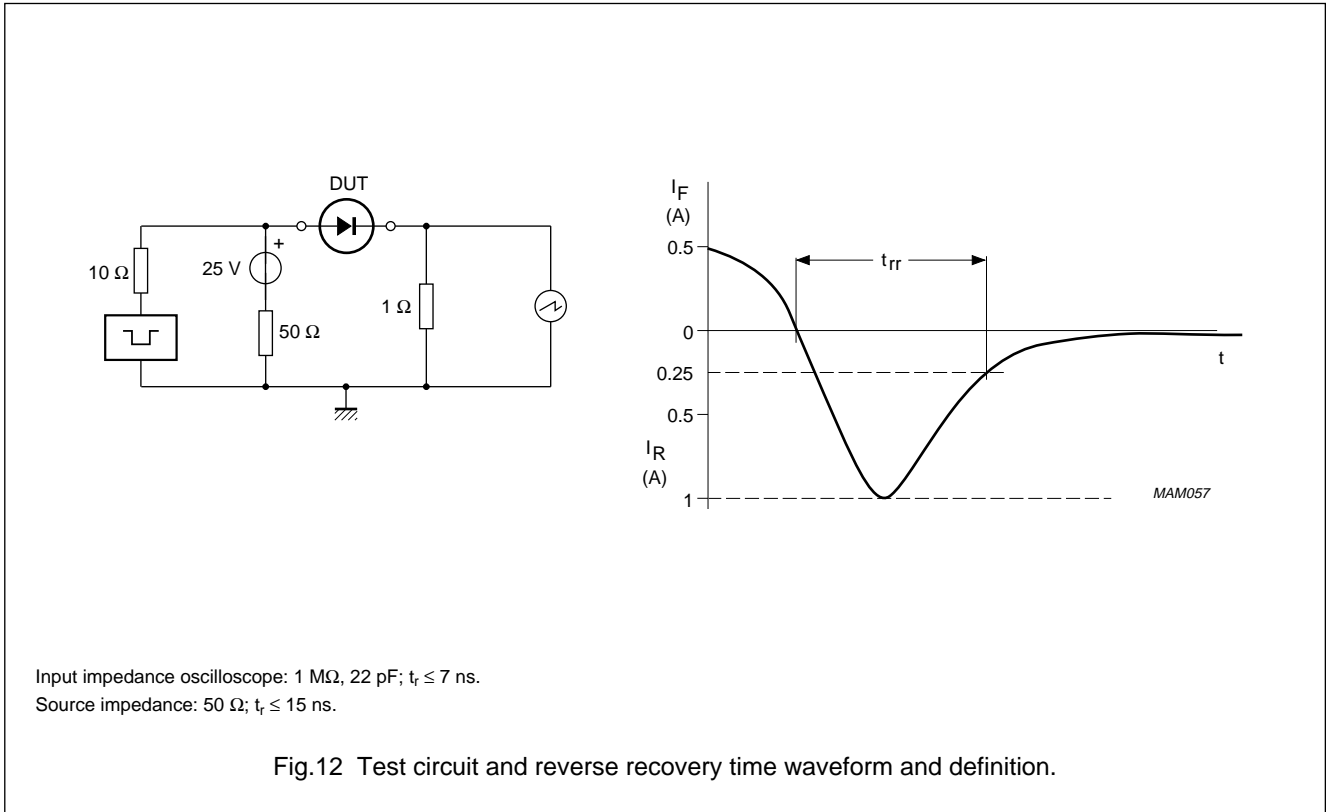

Fast soft-recovery
controlled avalanche rectifiers

BYD37 series

PACKAGE OUTLINE

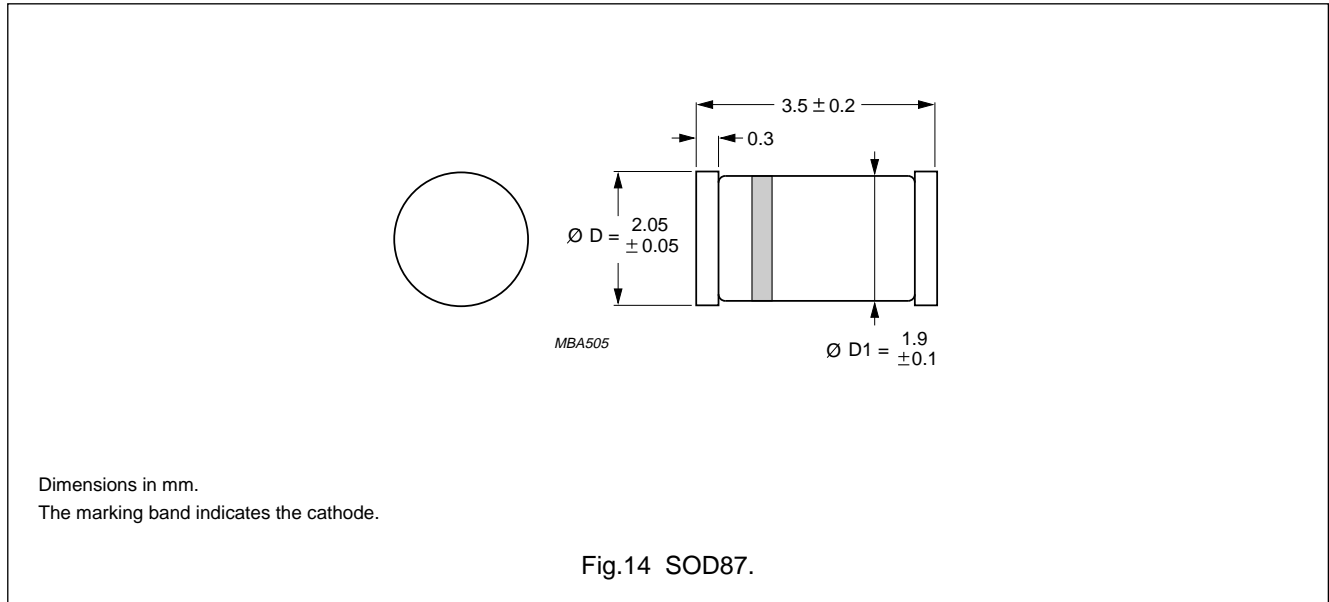

DEFINITIONS

Data Sheet Status	
Objective specification	This data sheet contains target or goal specifications for product development.
Preliminary specification	This data sheet contains preliminary data; supplementary data may be published later.
Product specification	This data sheet contains final product specifications.
Limiting values	
Limiting values given are in accordance with the Absolute Maximum Rating System (IEC 134). Stress above one or more of the limiting values may cause permanent damage to the device. These are stress ratings only and operation of the device at these or at any other conditions above those given in the Characteristics sections of the specification is not implied. Exposure to limiting values for extended periods may affect device reliability.	
Application information	
Where application information is given, it is advisory and does not form part of the specification.	

LIFE SUPPORT APPLICATIONS

These products are not designed for use in life support appliances, devices, or systems where malfunction of these products can reasonably be expected to result in personal injury. Philips customers using or selling these products for use in such applications do so at their own risk and agree to fully indemnify Philips for any damages resulting from such improper use or sale.