

DATA SHEET

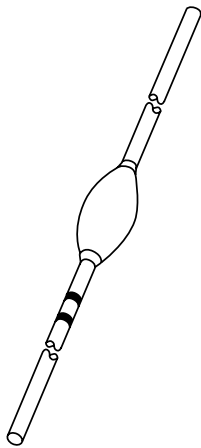

BY8400 series Fast high-voltage soft-recovery rectifiers

Product specification
Supersedes data of June 1994
File under Discrete Semiconductors, SC01

1996 May 24

Fast high-voltage soft-recovery rectifiers

BY8400 series

FEATURES

- Glass passivated
- High maximum operating temperature
- Low leakage current
- Excellent stability
- Soft-recovery switching characteristics
- Compact construction.

APPLICATIONS

- For colour television and monitors up to 25 kHz
- High-voltage applications for:
 - Multipliers
 - Slot-wound diode-split-transformers.

DESCRIPTION

Rugged glass package, using a high temperature alloyed construction.

This package is hermetically sealed and fatigue free as coefficients of expansion of all used parts are matched.

The package is designed to be used in an insulating medium such as resin, oil or SF6 gas.

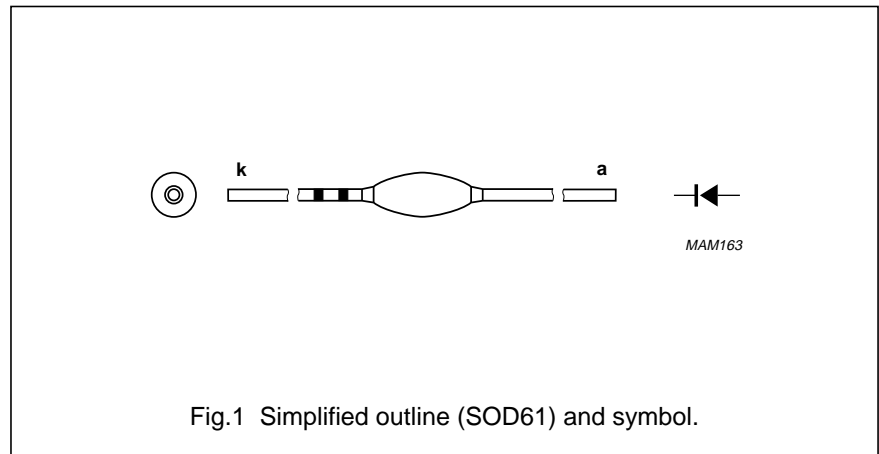

MARKING

Cathode band colour codes

TYPE NUMBER	PACKAGE CODE	INNER BAND	OUTER BAND
BY8404	SOD61AB	black	black
BY8406	SOD61AC	black	green
BY8408	SOD61AD	black	red
BY8410	SOD61AE	black	violet
BY8412	SOD61AF	black	orange
BY8414	SOD61AG	black	lilac
BY8416	SOD61AH	black	grey
BY8418	SOD61AI	black	brown
BY8420	SOD61AJ	black	dark blue
BY8424	SOD61AK	black	no band

Fast high-voltage soft-recovery rectifiers

BY8400 series

LIMITING VALUES

In accordance with the Absolute Maximum Rating System (IEC 134).

SYMBOL	PARAMETER	CONDITIONS	MIN.	MAX.	UNIT
V _{RSM}	non-repetitive peak reverse voltage				
	BY8404		–	5	kV
	BY8406		–	8	kV
	BY8408		–	10	kV
	BY8410		–	12	kV
	BY8412		–	14	kV
	BY8414		–	17	kV
	BY8416		–	19	kV
	BY8418		–	22	kV
	BY8420		–	24	kV
V _{RRM}	repetitive peak reverse voltage				
	BY8404		–	5	kV
	BY8406		–	8	kV
	BY8408		–	10	kV
	BY8410		–	12	kV
	BY8412		–	14	kV
	BY8414		–	17	kV
	BY8416		–	19	kV
	BY8418		–	22	kV
	BY8420		–	24	kV
V _{RW}	working reverse voltage				
	BY8404		–	4	kV
	BY8406		–	6	kV
	BY8408		–	8	kV
	BY8410		–	10	kV
	BY8412		–	12	kV
	BY8414		–	14	kV
	BY8416		–	16	kV
	BY8418		–	18	kV
	BY8420		–	20	kV
BY8424		–	24	kV	

Fast high-voltage soft-recovery rectifiers

BY8400 series

SYMBOL	PARAMETER	CONDITIONS	MIN.	MAX.	UNIT
$I_{F(AV)}$	average forward current	averaged over any 20 ms period; see Figs 2 to 11			
	BY8404		–	20	mA
	BY8406		–	10	mA
	BY8408		–	5	mA
	BY8410		–	5	mA
	BY8412		–	5	mA
	BY8414		–	5	mA
	BY8416		–	3	mA
	BY8418		–	3	mA
	BY8420		–	3	mA
	BY8424	–	3	mA	
I_{FRM}	repetitive peak forward current	note 1	–	500	mA
T_{stg}	storage temperature		–65	+120	°C
T_j	junction temperature		–65	+120	°C

Note

1. Withstands peak currents during flash-over in a picture tube.

Fast high-voltage soft-recovery rectifiers

BY8400 series

ELECTRICAL CHARACTERISTICS $T_j = 25\text{ }^\circ\text{C}$; unless otherwise specified.

SYMBOL	PARAMETER	CONDITIONS	MIN.	TYP.	MAX.	UNIT
V_F	forward voltage	$I_F = 100\text{ mA}$; $T_j = T_{j\text{ max}}$; see Figs 12 to 21	-	-	20	V
	BY8404					
	BY8406					
	BY8408					
	BY8410					
	BY8412					
	BY8414					
	BY8416					
	BY8418					
	BY8420					
BY8424						
I_R	reverse current	$V_R = V_{RW\text{ max}}$; $T_j = 120\text{ }^\circ\text{C}$	-	-	3	μA
Q_r	recovery charge	when switched from $I_F = 100\text{ mA}$ to $V_R \geq 100\text{ V}$ and $dI_F/dt = -200\text{ mA}/\mu\text{s}$; see Fig.22	-	-	1	nC
t_f	fall time	when switched from $I_F = 100\text{ mA}$ to $V_R \geq 100\text{ V}$ and $dI_F/dt = -200\text{ mA}/\mu\text{s}$; see Fig.22	100	-	-	ns
t_{rr}	reverse recovery time	when switched from $I_F = 2\text{ mA}$ to $I_R = 4\text{ mA}$; measured at $I_R = 1\text{ mA}$; see Fig.23	-	-	100	ns
C_d	diode capacitance	$V_R = 0\text{ V}$; $f = 1\text{ MHz}$	-	1.20	-	pF
	BY8404					
	BY8406					
	BY8408					
	BY8410					
	BY8412					
	BY8414					
	BY8416					
	BY8418					
	BY8420					
BY8424						

Fast high-voltage soft-recovery rectifiers

BY8400 series

GRAPHICAL DATA

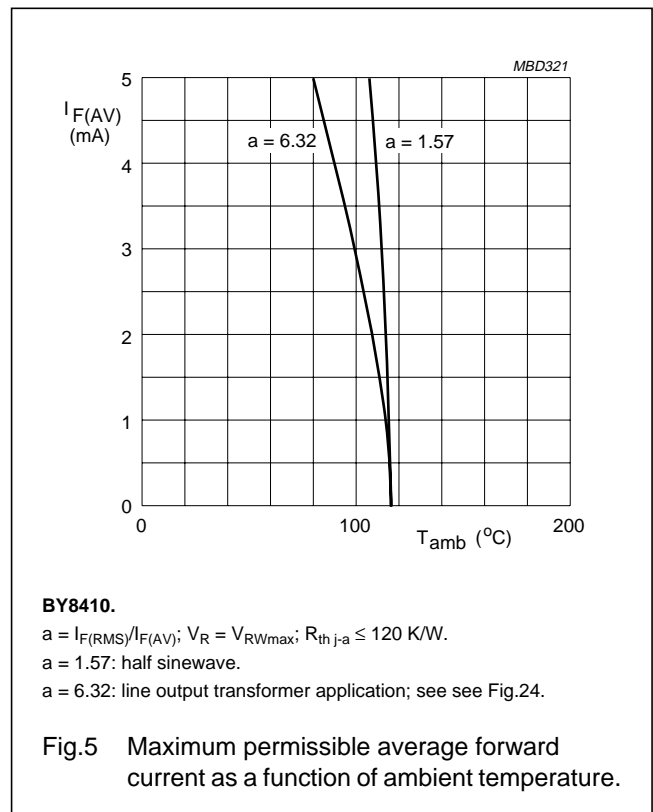
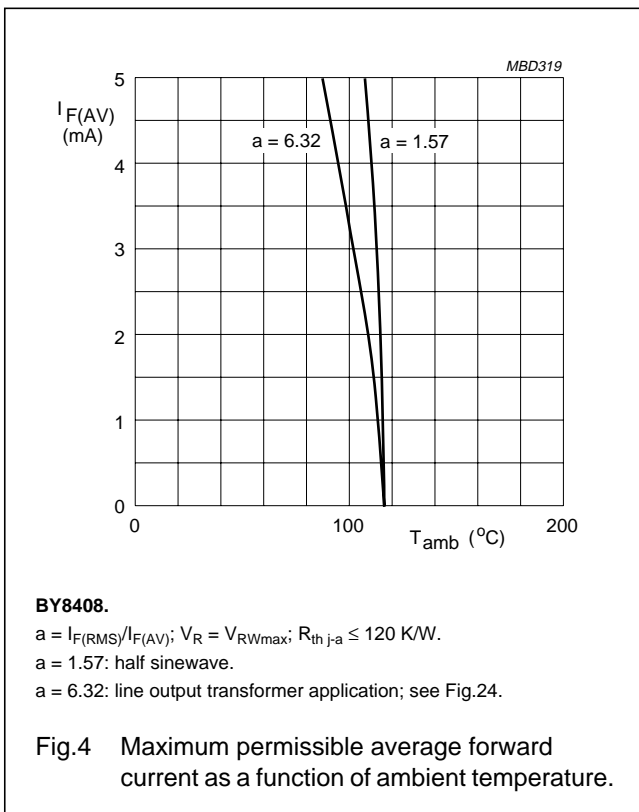
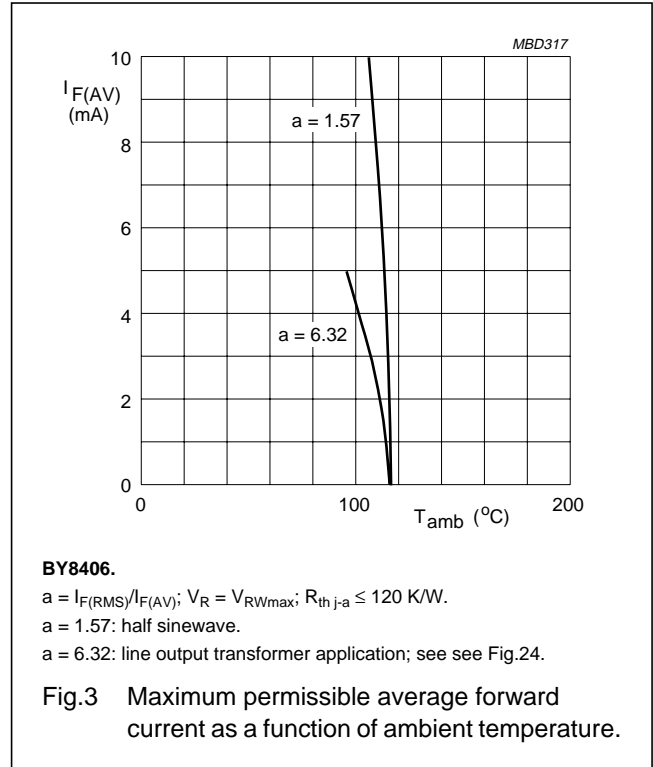
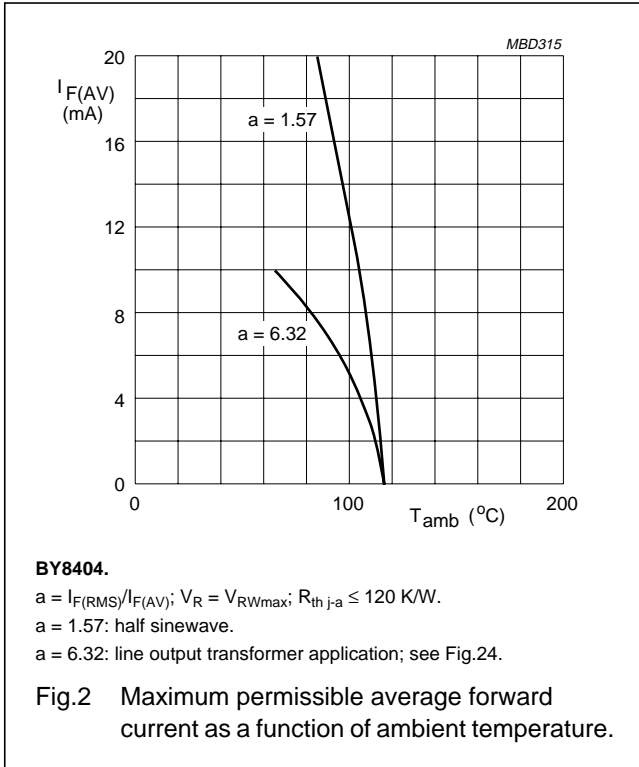

Fast high-voltage soft-recovery rectifiers

BY8400 series

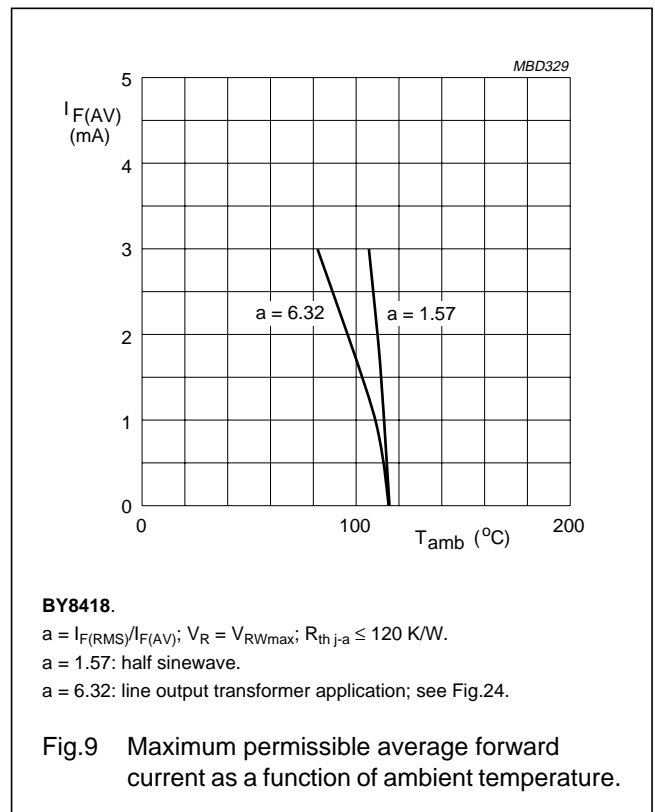
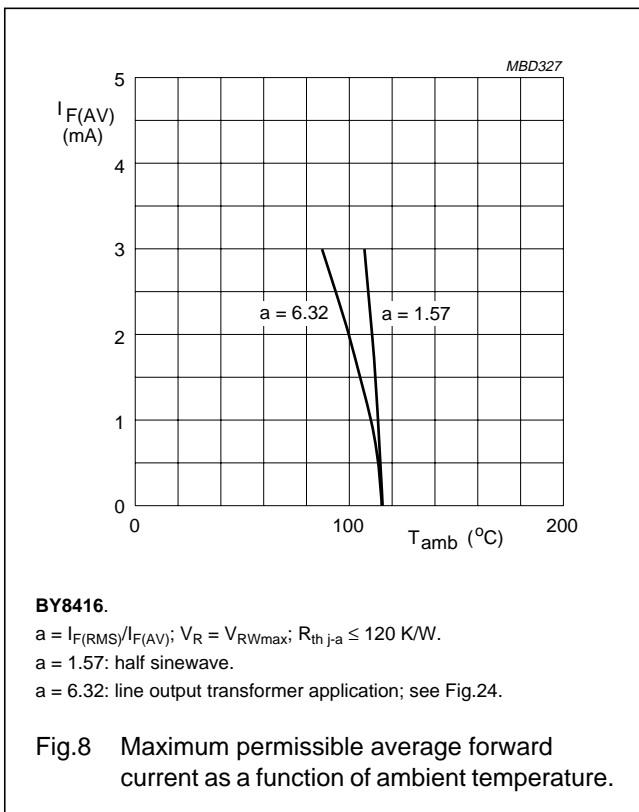
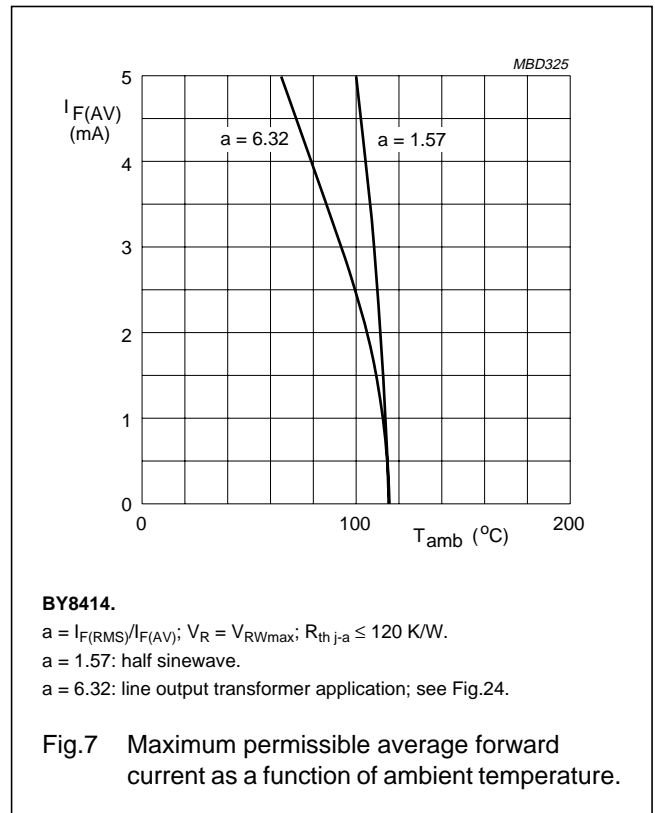
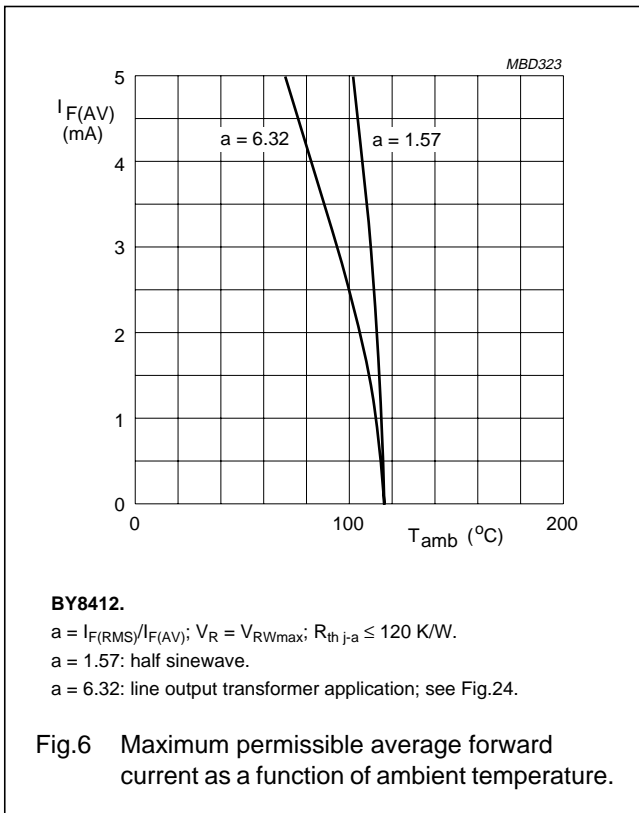

Fast high-voltage soft-recovery rectifiers

BY8400 series

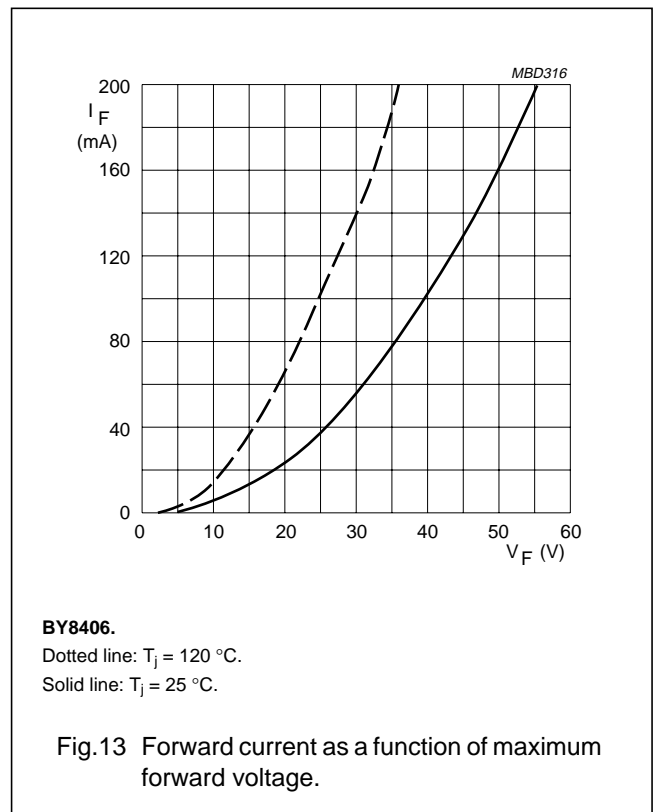
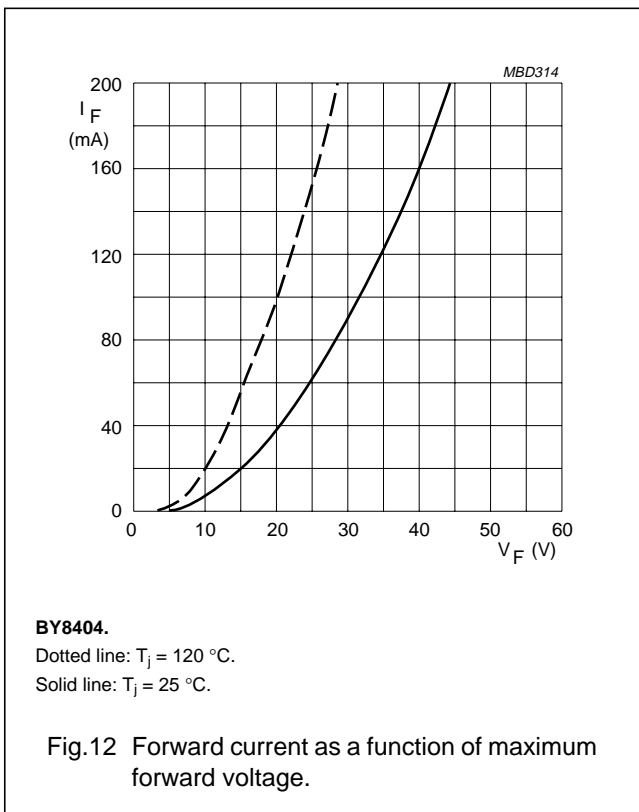
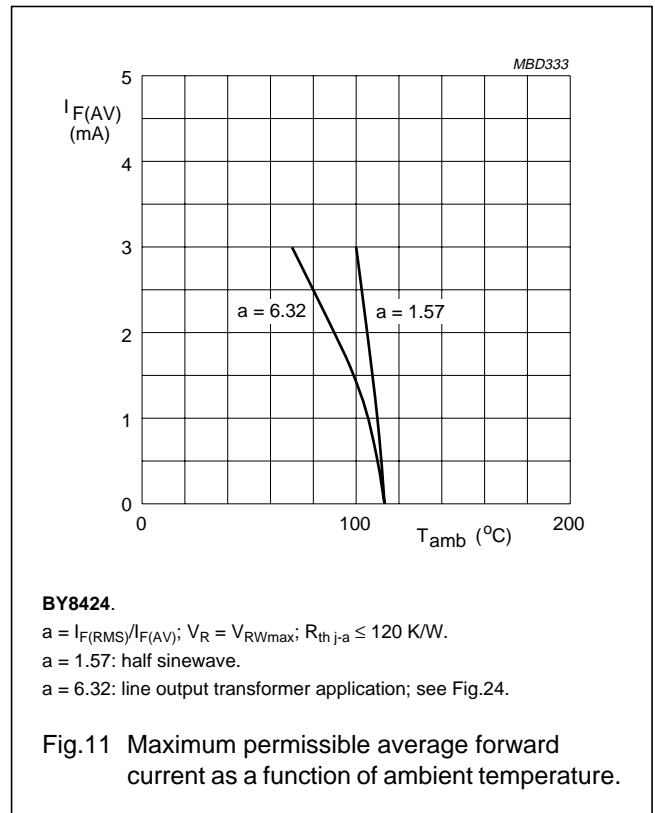
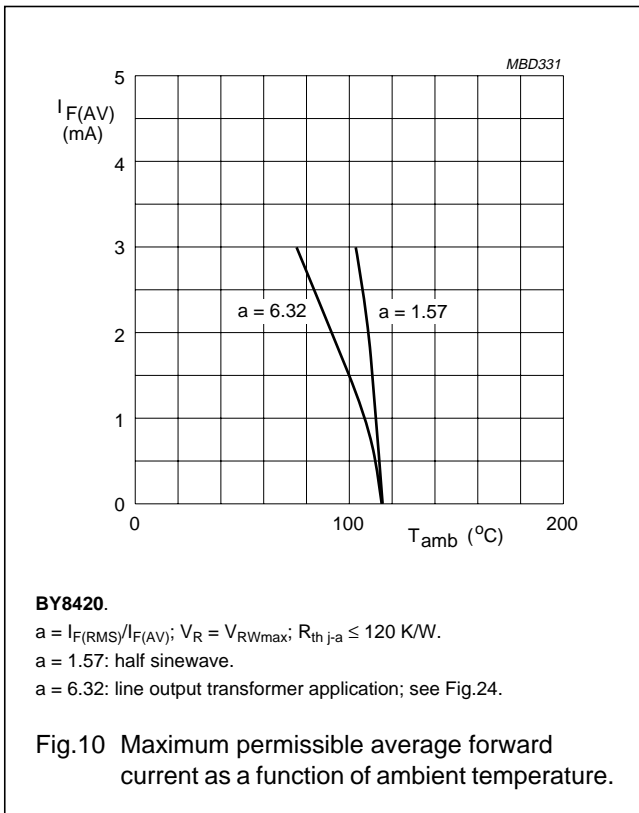

Fast high-voltage soft-recovery rectifiers

BY8400 series

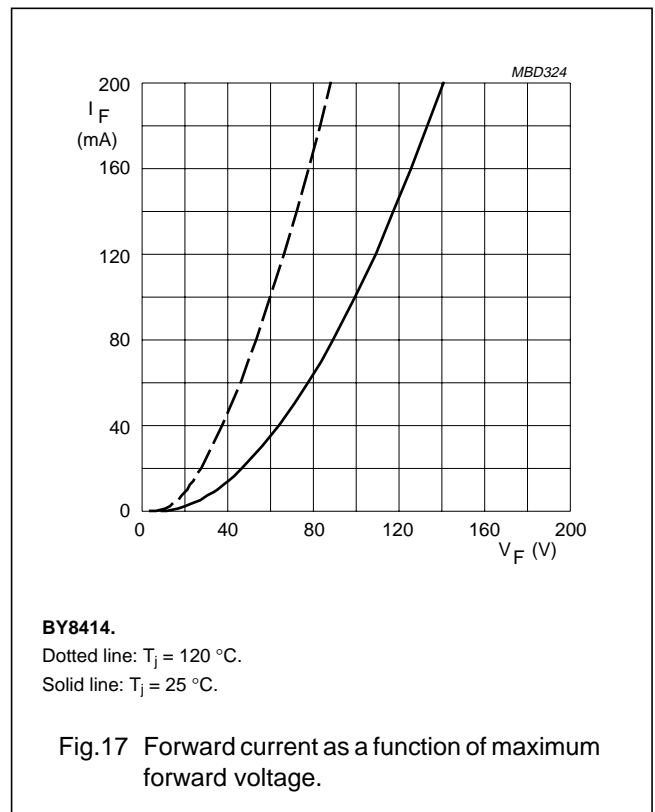
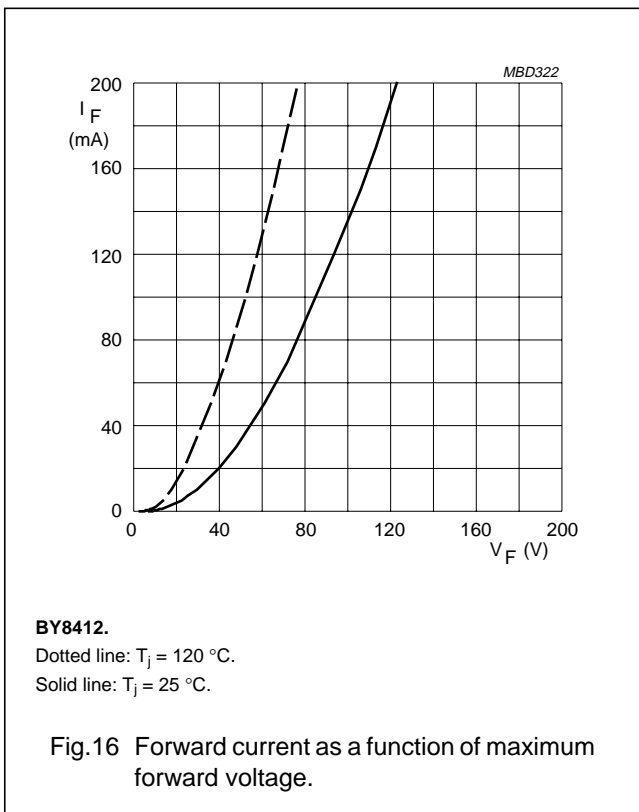
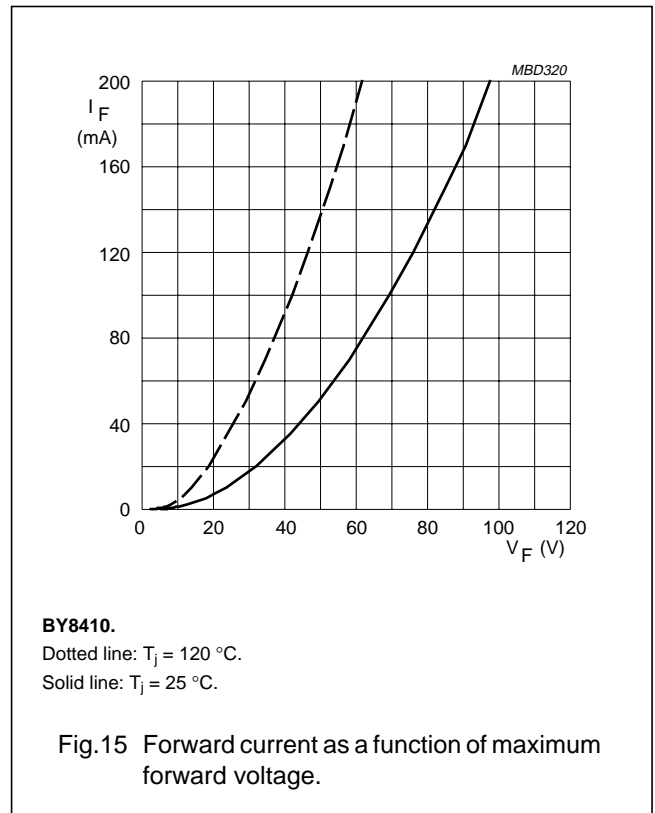
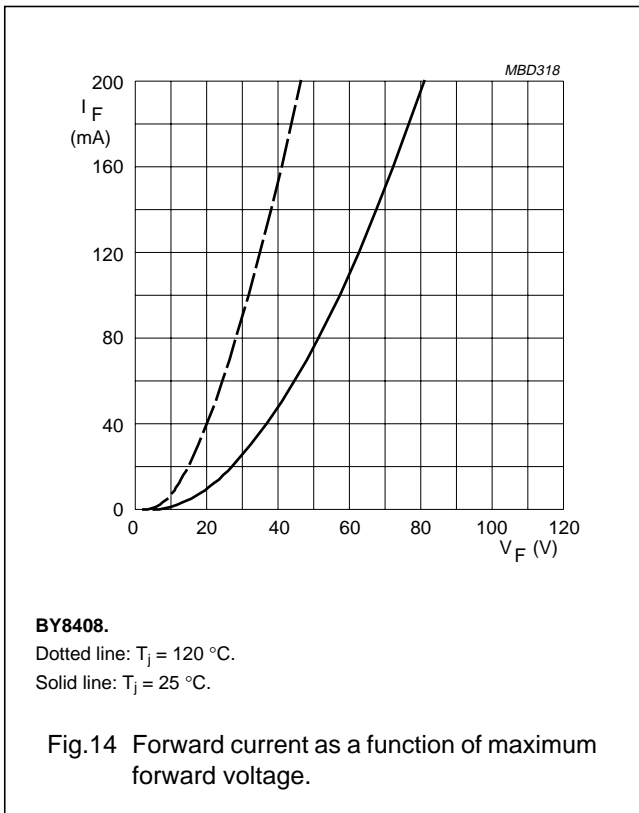

Fast high-voltage soft-recovery rectifiers

BY8400 series

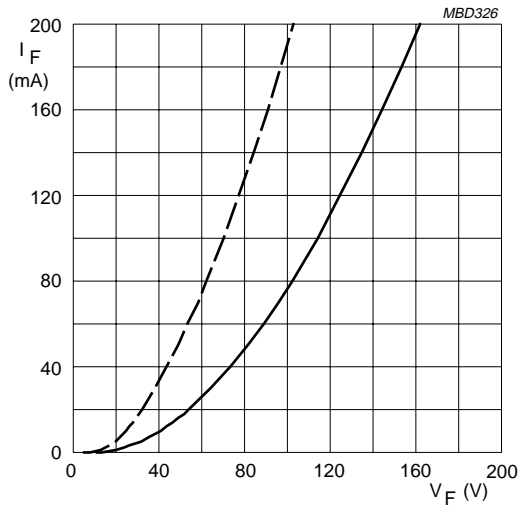

BY8416.
Dotted line: $T_j = 120\text{ }^\circ\text{C}$.
Solid line: $T_j = 25\text{ }^\circ\text{C}$.

Fig.18 Forward current as a function of maximum forward voltage.

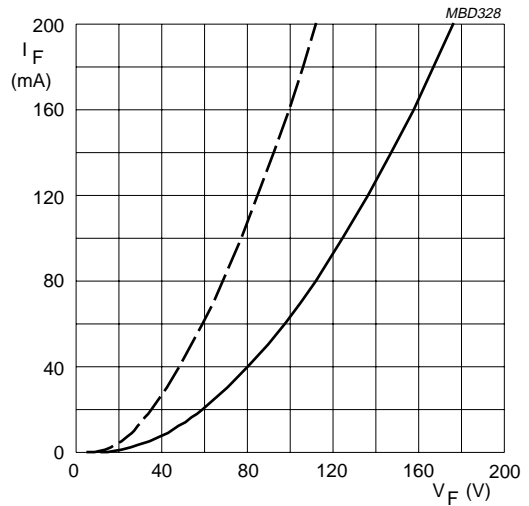

BY8418.
Dotted line: $T_j = 120\text{ }^\circ\text{C}$.
Solid line: $T_j = 25\text{ }^\circ\text{C}$.

Fig.19 Forward current as a function of maximum forward voltage.

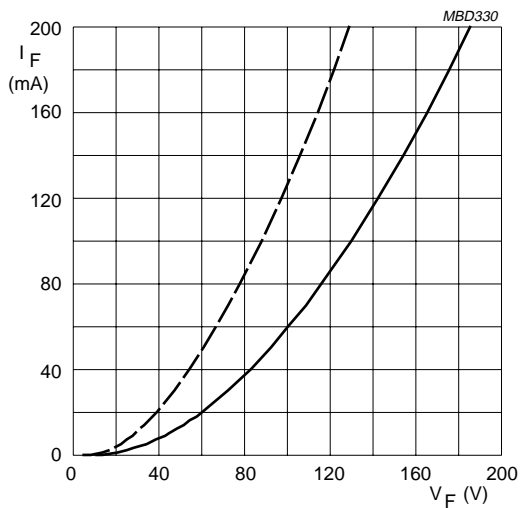

BY8420.
Dotted line: $T_j = 120\text{ }^\circ\text{C}$.
Solid line: $T_j = 25\text{ }^\circ\text{C}$.

Fig.20 Forward current as a function of maximum forward voltage.

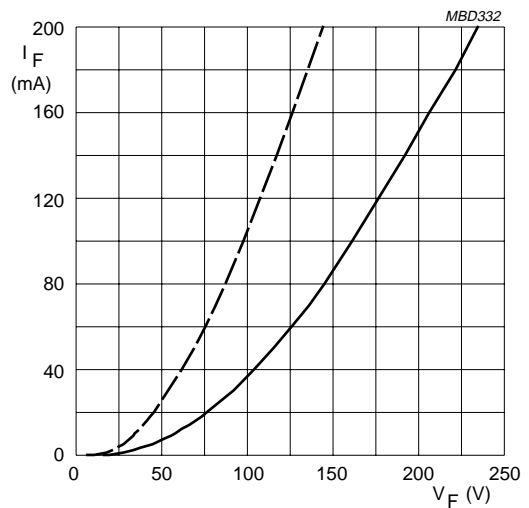

BY8424.
Dotted line: $T_j = 120\text{ }^\circ\text{C}$.
Solid line: $T_j = 25\text{ }^\circ\text{C}$.

Fig.21 Forward current as a function of maximum forward voltage.

Fast high-voltage soft-recovery rectifiers

BY8400 series

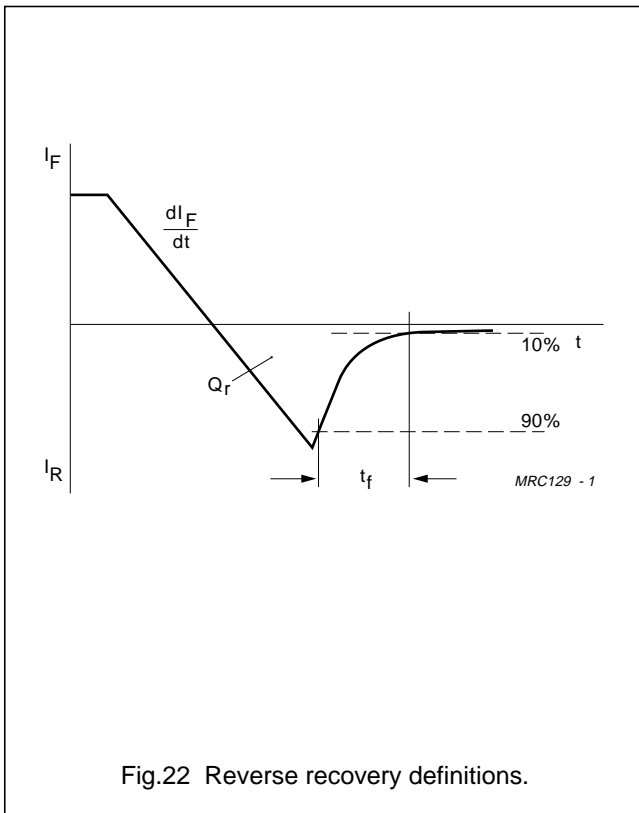
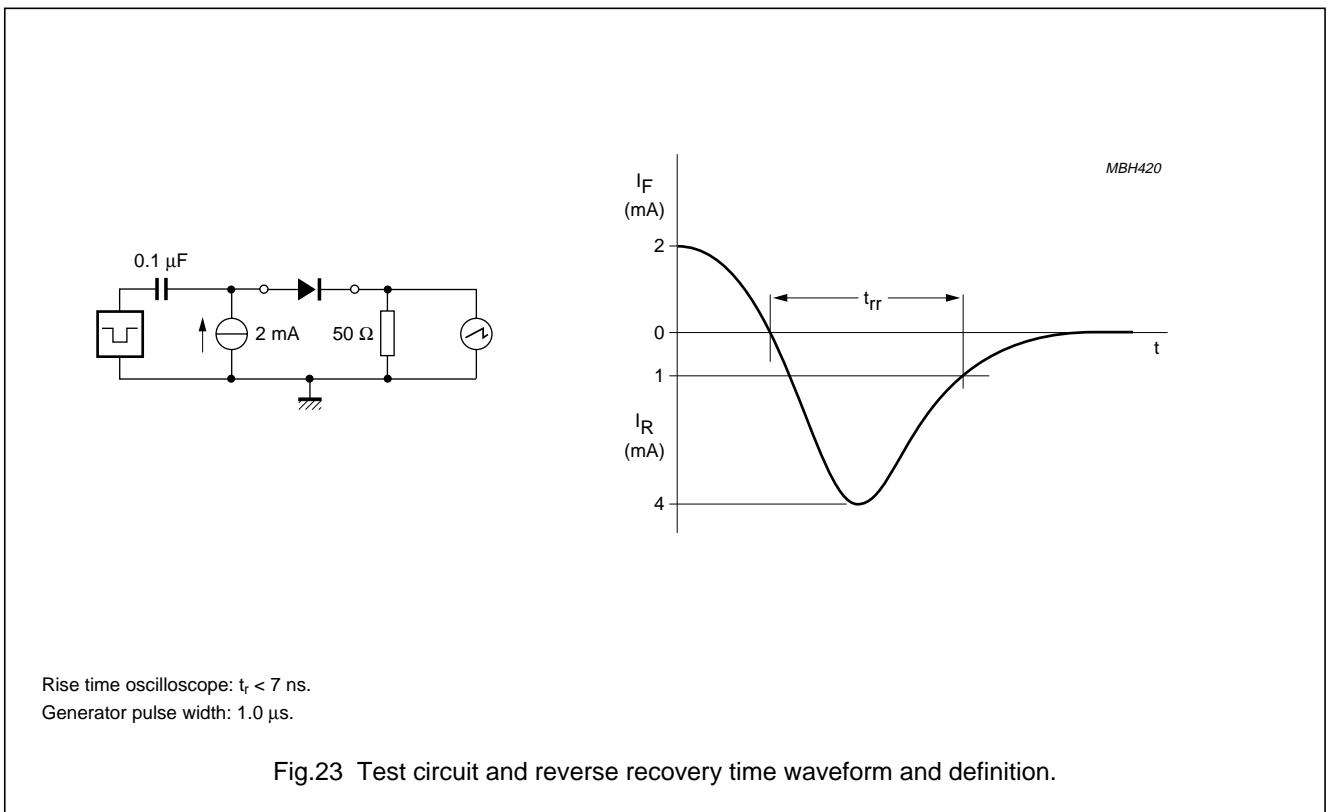

Fig.22 Reverse recovery definitions.



Rise time oscilloscope: $t_r < 7 \text{ ns}$.
 Generator pulse width: 1.0 μs .

Fig.23 Test circuit and reverse recovery time waveform and definition.

Fast high-voltage soft-recovery rectifiers

BY8400 series

APPLICATION INFORMATION

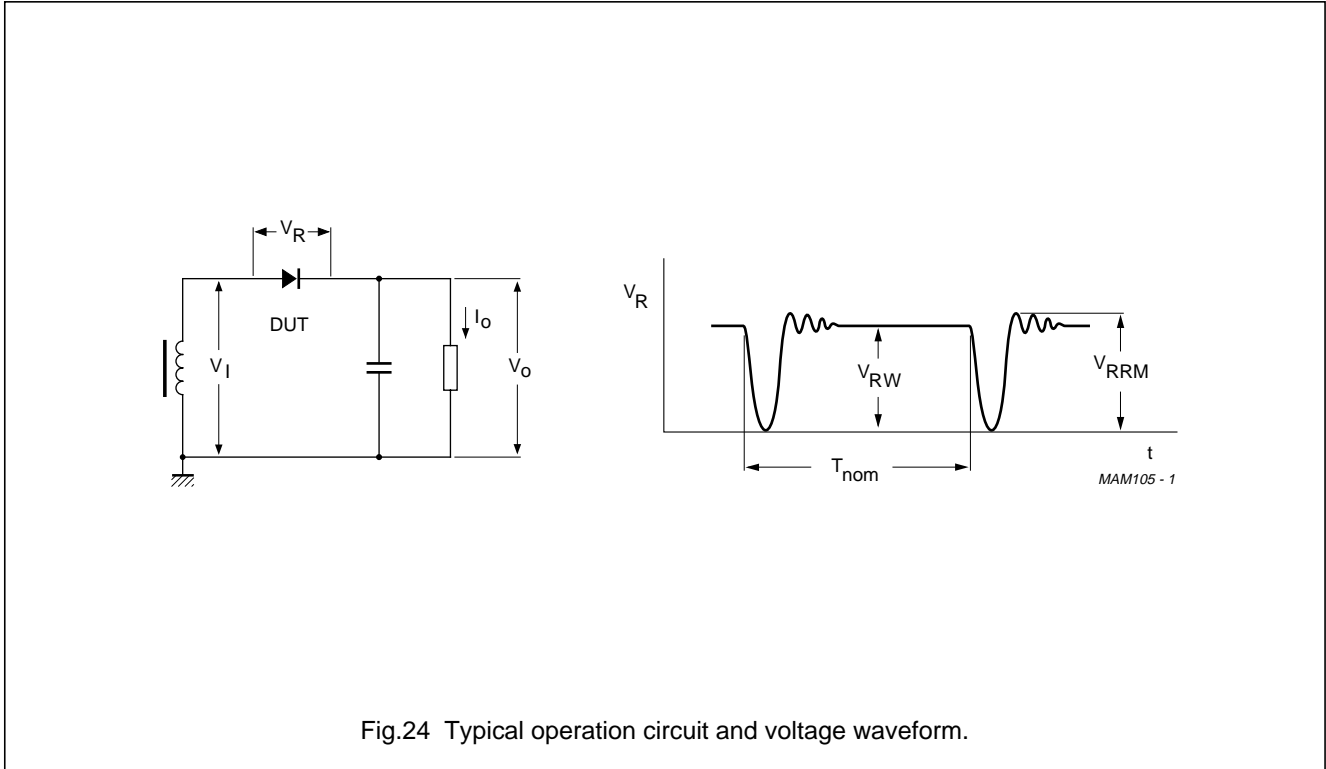
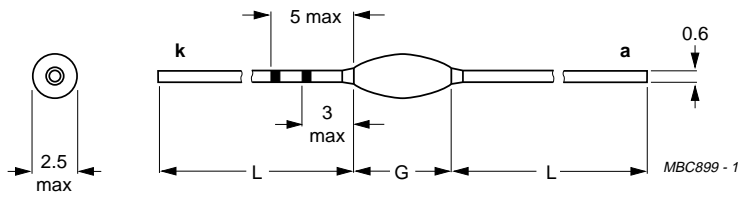

Fig.24 Typical operation circuit and voltage waveform.

Fast high-voltage soft-recovery rectifiers

BY8400 series

PACKAGE OUTLINE



Dimensions in mm.

Fig.25 SOD61.

SOD61 package specification

TYPE NUMBER	PACKAGE CODE	L _{min} (mm)	G _{max} (mm)
BY8404	SOD61AB	31.8	5.5
BY8406	SOD61AC	30.4	8.3
BY8408	SOD61AD	30.2	8.7
BY8410	SOD61AE	30.0	9.1
BY8412	SOD61AF	29.8	9.5
BY8414	SOD61AG	29.6	9.9
BY8416	SOD61AH	29.3	10.5
BY8418	SOD61AI	28.8	11.5
BY8420	SOD61AJ	28.3	12.5
BY8424	SOD61AK	27.8	13.5

Fast high-voltage soft-recovery rectifiers

BY8400 series

DEFINITIONS

Data Sheet Status	
Objective specification	This data sheet contains target or goal specifications for product development.
Preliminary specification	This data sheet contains preliminary data; supplementary data may be published later.
Product specification	This data sheet contains final product specifications.
Limiting values	
Limiting values given are in accordance with the Absolute Maximum Rating System (IEC 134). Stress above one or more of the limiting values may cause permanent damage to the device. These are stress ratings only and operation of the device at these or at any other conditions above those given in the Characteristics sections of the specification is not implied. Exposure to limiting values for extended periods may affect device reliability.	
Application information	
Where application information is given, it is advisory and does not form part of the specification.	

LIFE SUPPORT APPLICATIONS

These products are not designed for use in life support appliances, devices, or systems where malfunction of these products can reasonably be expected to result in personal injury. Philips customers using or selling these products for use in such applications do so at their own risk and agree to fully indemnify Philips for any damages resulting from such improper use or sale.