

TrenchMOS™ transistor
Standard level FET

BUK7840-55

GENERAL DESCRIPTION

N-channel enhancement mode logic level field-effect power transistor in a plastic envelope suitable for surface mounting. Using 'trench' technology the device features very low on-state resistance and has integral zener diodes giving ESD protection. It is intended for use in automotive and general purpose switching applications.

QUICK REFERENCE DATA

SYMBOL	PARAMETER	MAX.	UNIT
V_{DS}	Drain-source voltage	55	V
I_D	Drain current	10.7	A
P_{tot}	Total power dissipation	1.8	W
T_j	Junction temperature	150	°C
$R_{DS(ON)}$	Drain-source on-state resistance $V_{GS} = 10\text{ V}$	40	mΩ

PINNING - SOT223

PIN	DESCRIPTION
1	gate
2	drain
3	source
4	drain (tab)

PIN CONFIGURATION

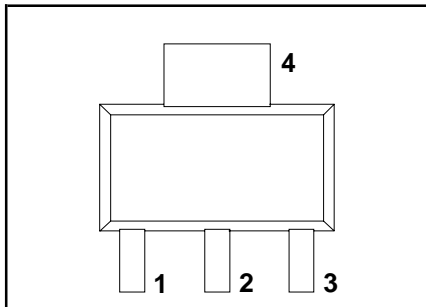

SYMBOL

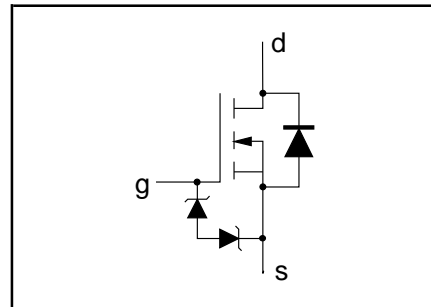

LIMITING VALUES

Limiting values in accordance with the Absolute Maximum System (IEC 134)

SYMBOL	PARAMETER	CONDITIONS	MIN.	MAX.	UNIT
V_{DS}	Drain-source voltage	-	-	55	V
V_{DGR}	Drain-gate voltage	$R_{GS} = 20\text{ k}\Omega$	-	55	V
$\pm V_{GS}$	Gate-source voltage	-	-	16	V
I_D	Drain current (DC)	$T_{sp} = 25\text{ }^\circ\text{C}$	-	10.7	A
I_D	Drain current (DC)	On PCB in Fig.19	-	5	A
I_D	Drain current (DC)	$T_{amb} = 25\text{ }^\circ\text{C}$	-	3.1	A
I_D	Drain current (DC)	On PCB in Fig.19	-	3.1	A
I_{DM}	Drain current (pulse peak value)	$T_{amb} = 100\text{ }^\circ\text{C}$	-	40	A
P_{tot}	Total power dissipation	$T_{sp} = 25\text{ }^\circ\text{C}$	-	10.7	W
P_{tot}	Total power dissipation	On PCB in Fig.19	-	1.8	W
T_{stg}, T_j	Storage & operating temperature	$T_{amb} = 25\text{ }^\circ\text{C}$	-55	150	°C

ESD LIMITING VALUE

SYMBOL	PARAMETER	CONDITIONS	MIN.	MAX.	UNIT
V_C	Electrostatic discharge capacitor voltage	Human body model (100 pF, 1.5 kΩ)	-	2	kV

TrenchMOS™ transistor Standard level FET

BUK7840-55

THERMAL RESISTANCES

SYMBOL	PARAMETER	CONDITIONS	TYP.	MAX.	UNIT
$R_{th\ j-sp}$	From junction to solder point	Mounted on any PCB	12	15	K/W
$R_{th\ j-amb}$	From junction to ambient	Mounted on PCB of Fig.18	-	70	K/W

STATIC CHARACTERISTICS

$T_j = 25^\circ\text{C}$ unless otherwise specified

SYMBOL	PARAMETER	CONDITIONS	MIN.	TYP.	MAX.	UNIT
$V_{(BR)DSS}$	Drain-source breakdown voltage	$V_{GS} = 0\text{ V}; I_D = 0.25\text{ mA}$ $T_j = -55^\circ\text{C}$	55 50	- -	- -	V V
$V_{GS(TO)}$	Gate threshold voltage	$V_{DS} = V_{GS}; I_D = 1\text{ mA}$ $T_j = 150^\circ\text{C}$ $T_j = -55^\circ\text{C}$	2.0 1.2 -	3.0 - -	4.0 - 4.4	V V V
I_{DSS}	Zero gate voltage drain current	$V_{DS} = 55\text{ V}; V_{GS} = 0\text{ V};$ $T_j = 150^\circ\text{C}$	-	0.05	10	μA
I_{GSS}	Gate source leakage current	$V_{GS} = \pm 10\text{ V}$ $T_j = 150^\circ\text{C}$	-	0.04	1	μA
$\pm V_{(BR)GSS}$	Gate source breakdown voltage	$I_G = \pm 1\text{ mA}$ $T_j = 150^\circ\text{C}$	16	-	-	V
$R_{DS(ON)}$	Drain-source on-state resistance	$V_{GS} = 10\text{ V}; I_D = 5\text{ A}$ $T_j = 150^\circ\text{C}$	-	30	40	m Ω m Ω

DYNAMIC CHARACTERISTICS

$T_{mb} = 25^\circ\text{C}$ unless otherwise specified

SYMBOL	PARAMETER	CONDITIONS	MIN.	TYP.	MAX.	UNIT
g_{fs}	Forward transconductance	$V_{DS} = 25\text{ V}; I_D = 5\text{ A}; T_j = 25^\circ\text{C}$	3	12	-	S
C_{iss}	Input capacitance	$V_{GS} = 0\text{ V}; V_{DS} = 25\text{ V}; f = 1\text{ MHz}$	-	700	880	pF
C_{oss}	Output capacitance		-	200	240	pF
C_{rss}	Feedback capacitance		-	100	140	pF
$t_{d\ on}$	Turn-on delay time	$V_{DD} = 30\text{ V}; I_D = 9\text{ A};$ $V_{GS} = 10\text{ V}; R_g = 10\ \Omega$ $T_j = 25^\circ\text{C}$	-	15	23	ns
t_r	Turn-on rise time		-	50	75	ns
$t_{d\ off}$	Turn-off delay time		-	33	50	ns
t_f	Turn-off fall time		-	20	30	ns

REVERSE DIODE LIMITING VALUES AND CHARACTERISTICS

$T_j = -55$ to 175°C unless otherwise specified

SYMBOL	PARAMETER	CONDITIONS	MIN.	TYP.	MAX.	UNIT
I_{DR}	Continuous reverse drain current	$T_{sp} = 25^\circ\text{C}$	-	-	10.7	A
I_{DRM}	Pulsed reverse drain current	$T_{sp} = 25^\circ\text{C}$	-	-	40	A
V_{SD}	Diode forward voltage	$I_F = 5\text{ A}; V_{GS} = 0\text{ V}$	-	0.85	1.1	V
t_{rr}	Reverse recovery time	$I_F = 5\text{ A}; -di_F/dt = 100\text{ A}/\mu\text{s};$ $V_{GS} = -10\text{ V}; V_R = 30\text{ V}$	-	45	-	ns
Q_{rr}	Reverse recovery charge		-	0.3	-	μC

TrenchMOS™ transistor
Standard level FET

BUK7840-55

AVALANCHE LIMITING VALUE

SYMBOL	PARAMETER	CONDITIONS	MIN.	TYP.	MAX.	UNIT
W_{DSS}	Drain-source non-repetitive unclamped inductive turn-off energy	$I_D = 3.6 \text{ A}; V_{DD} \leq 25 \text{ V}; V_{GS} = 10 \text{ V}; R_{GS} = 50 \text{ } \Omega; T_{sp} = 25 \text{ } ^\circ\text{C}$	-	-	60	mJ

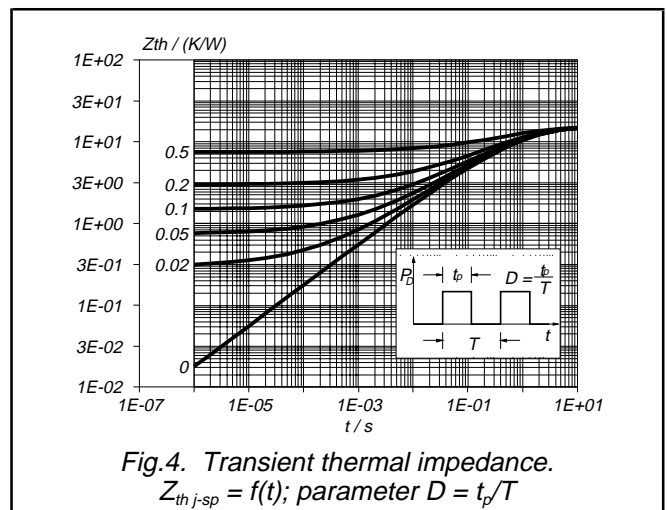
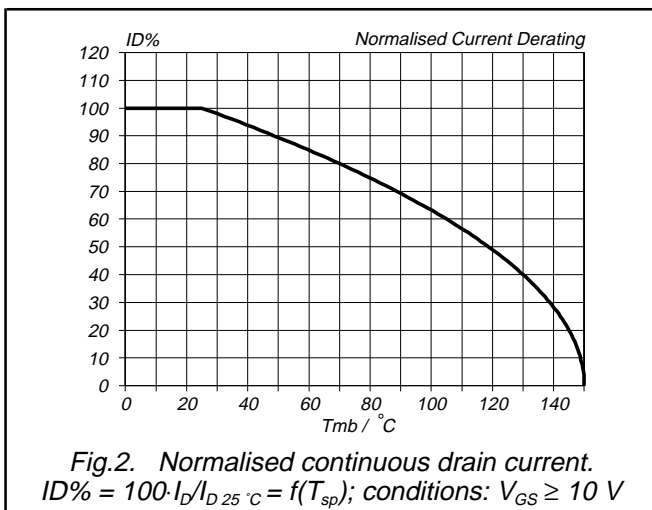
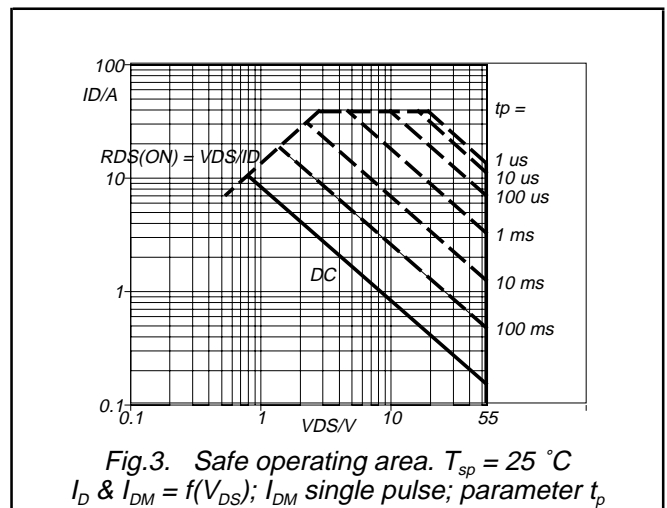
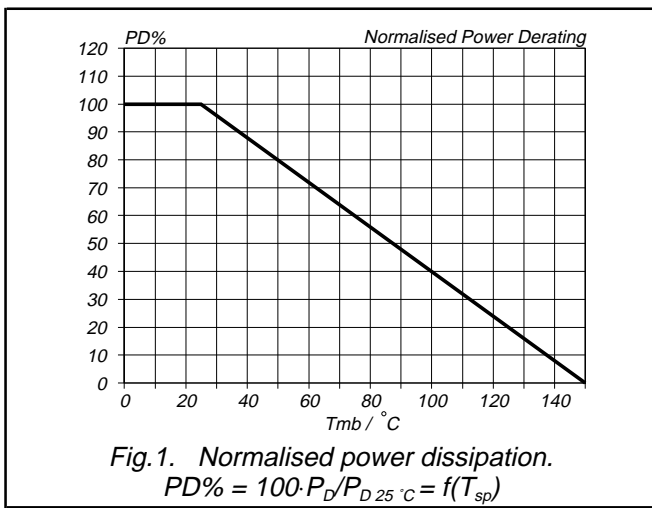

TrenchMOS™ transistor
Standard level FET

BUK7840-55

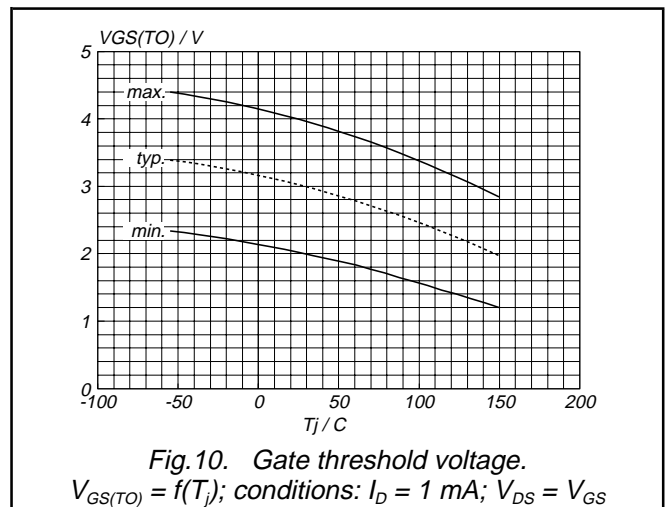
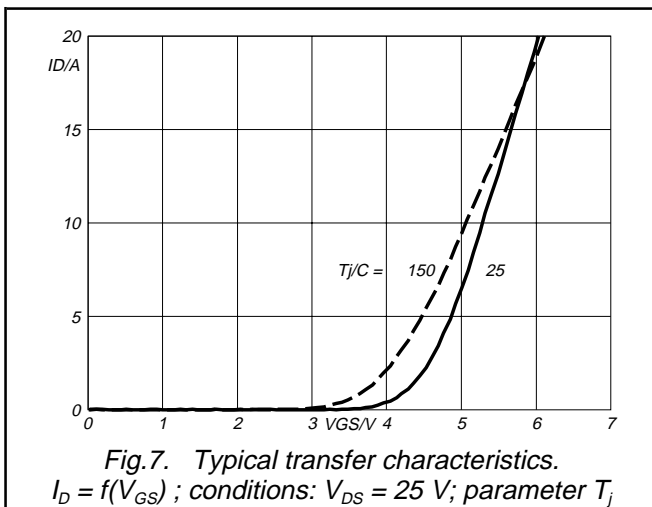
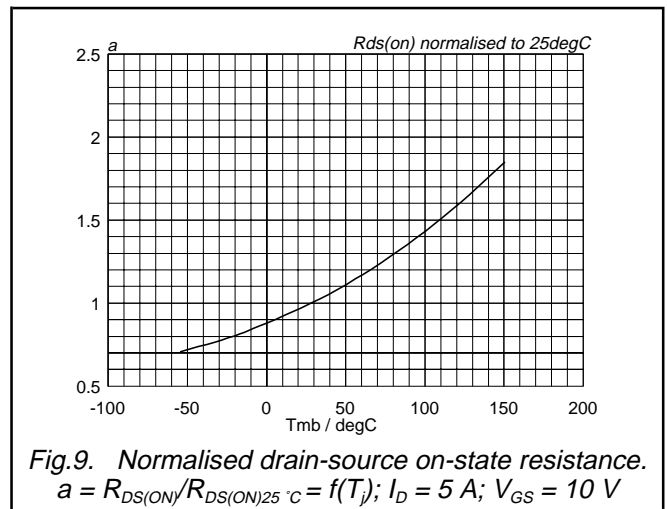
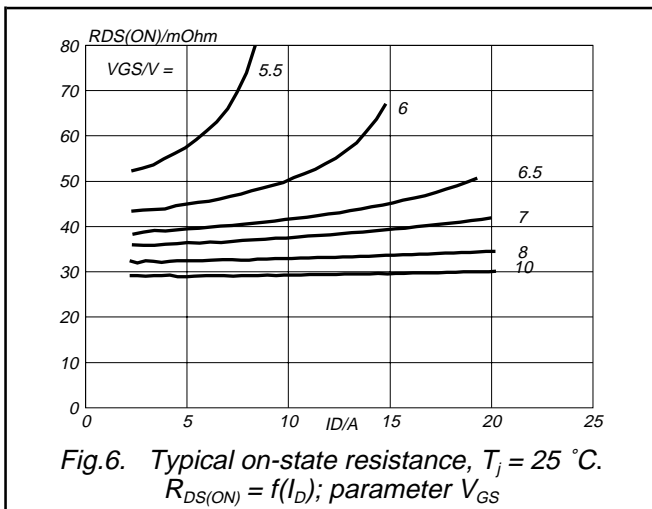
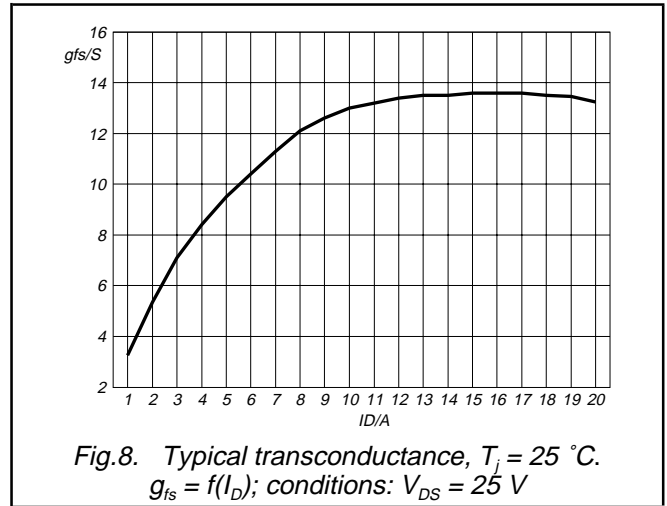
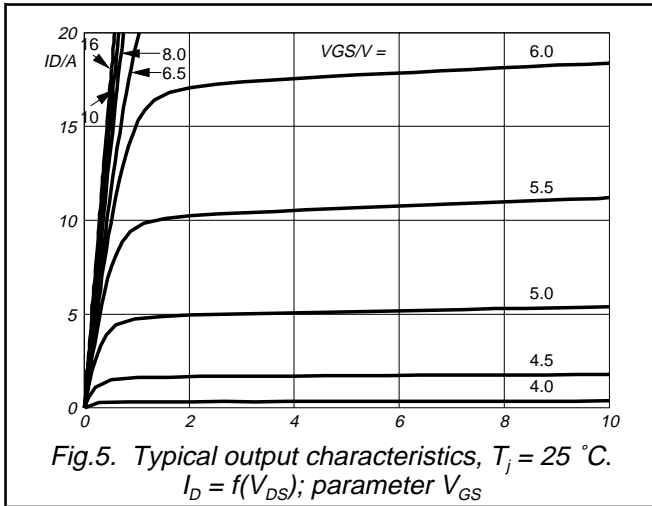

TrenchMOS™ transistor
Standard level FET

BUK7840-55

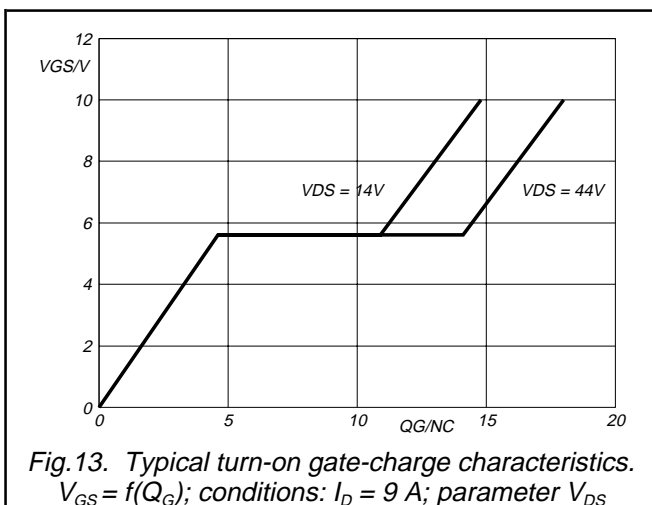
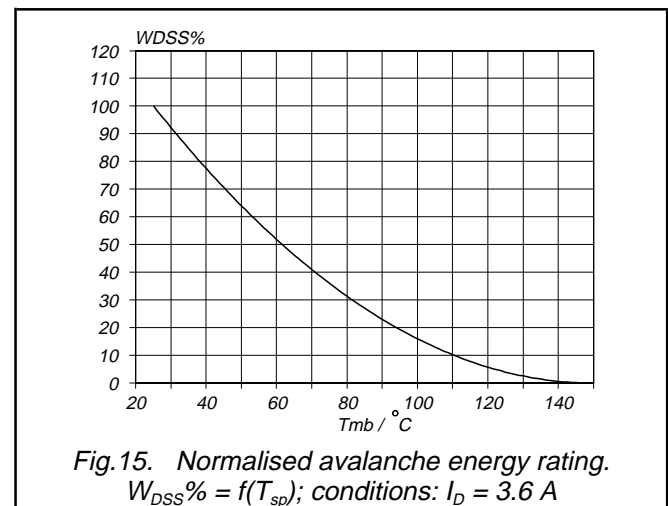
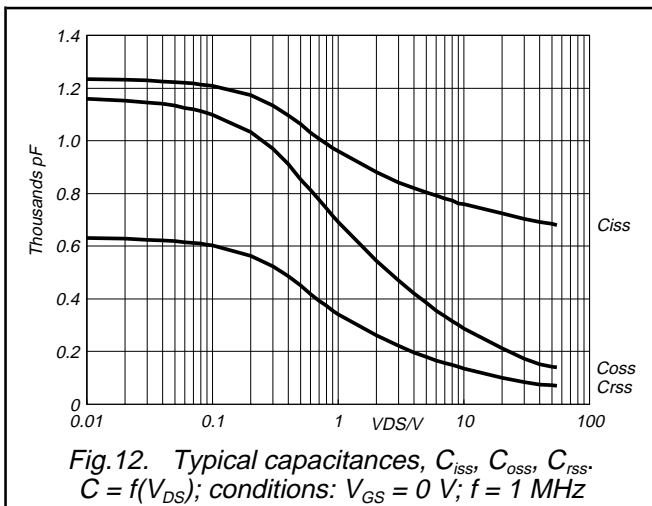
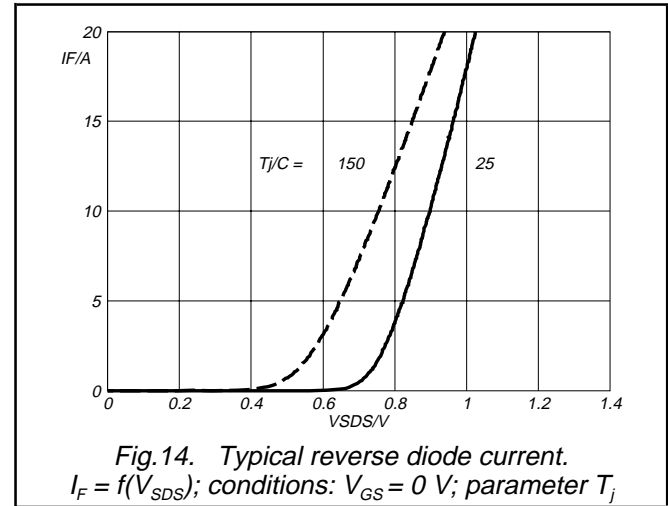

TrenchMOS™ transistor
Standard level FET

BUK7840-55



Fig.17. Switching test circuit.

TrenchMOS™ transistor
Standard level FET

BUK7840-55

PRINTED CIRCUIT BOARD



TrenchMOS™ transistor
Standard level FET

BUK7840-55

DEFINITIONS

Data sheet status	
Objective specification	This data sheet contains target or goal specifications for product development.
Preliminary specification	This data sheet contains preliminary data; supplementary data may be published later.
Product specification	This data sheet contains final product specifications.
Limiting values	
Limiting values are given in accordance with the Absolute Maximum Rating System (IEC 134). Stress above one or more of the limiting values may cause permanent damage to the device. These are stress ratings only and operation of the device at these or at any other conditions above those given in the Characteristics sections of this specification is not implied. Exposure to limiting values for extended periods may affect device reliability.	
Application information	
Where application information is given, it is advisory and does not form part of the specification.	
© Philips Electronics N.V. 1998	
All rights are reserved. Reproduction in whole or in part is prohibited without the prior written consent of the copyright owner.	
The information presented in this document does not form part of any quotation or contract, it is believed to be accurate and reliable and may be changed without notice. No liability will be accepted by the publisher for any consequence of its use. Publication thereof does not convey nor imply any license under patent or other industrial or intellectual property rights.	

LIFE SUPPORT APPLICATIONS

These products are not designed for use in life support appliances, devices or systems where malfunction of these products can be reasonably expected to result in personal injury. Philips customers using or selling these products for use in such applications do so at their own risk and agree to fully indemnify Philips for any damages resulting from such improper use or sale.