

**Rectifier diodes  
Schottky barrier**

**PBYR2045CTF, PBYR2045CTX series**

**FEATURES**

- Low forward volt drop
- Fast switching
- Reverse surge capability
- High thermal cycling performance
- Isolated mounting tab

**SYMBOL**



**QUICK REFERENCE DATA**

$V_R = 40\text{ V} / 45\text{ V}$
$I_{O(AV)} = 20\text{ A}$
$V_F \leq 0.57\text{ V}$

**GENERAL DESCRIPTION**

Dual, common cathode schottky rectifier diodes in a plastic envelope with electrically isolated mounting tab. Intended for use as output rectifiers in low voltage, high frequency switched mode power supplies.

The PBYR2045CTF series is supplied in the SOT186 package.  
The PBYR2045CTX series is supplied in the SOT186A package.

**PINNING**

PIN	DESCRIPTION
1	anode 1 (a)
2	cathode (k)
3	anode 2 (a)
tab	isolated

**SOT186**

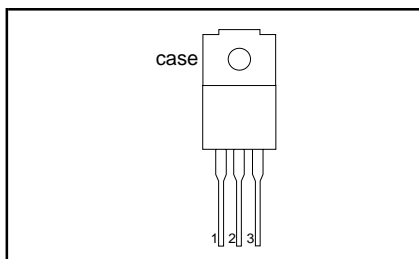

**SOT186A**

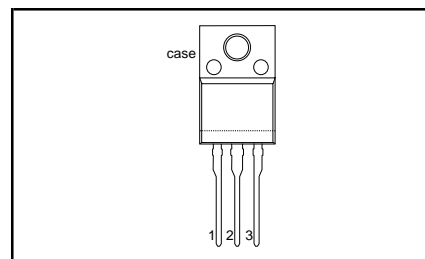

**LIMITING VALUES**

Limiting values in accordance with the Absolute Maximum System (IEC 134)

SYMBOL	PARAMETER	CONDITIONS	MIN.	MAX.		UNIT
				40CTF 40CTX	45CTF 45CTX	
$V_{RRM}$	Peak repetitive reverse voltage	PBYR20 PBYR20	-	40	45	V
$V_{RWM}$	Working peak reverse voltage		-	40	45	V
$V_R$	Continuous reverse voltage	$T_{hs} \leq 84\text{ }^\circ\text{C}$	-	40	45	V
$I_{O(AV)}$	Average rectified output current (both diodes conducting)	square wave; $\delta = 0.5$ ; $T_{hs} \leq 78\text{ }^\circ\text{C}$	-	20		A
$I_{FRM}$	Repetitive peak forward current per diode	square wave; $\delta = 0.5$ ; $T_{hs} \leq 78\text{ }^\circ\text{C}$	-	20		A
$I_{FSM}$	Non-repetitive peak forward current per diode	$t = 10\text{ ms}$	-	100		A
		$t = 8.3\text{ ms}$	-	110		A
$I_{RRM}$	Peak repetitive reverse surge current per diode	sinusoidal; $T_j = 125\text{ }^\circ\text{C}$ prior to surge; with reapplied $V_{RRM(max)}$ pulse width and repetition rate limited by $T_{jmax}$	-	1		A
$T_j$	Operating junction temperature		-	150		$^\circ\text{C}$
$T_{stg}$	Storage temperature		- 65	175		$^\circ\text{C}$

**Rectifier diodes  
Schottky barrier**
**PBYR2045CTF, PBYR2045CTX series**
**ISOLATION LIMITING VALUE & CHARACTERISTIC**
 $T_{hs} = 25\text{ °C}$  unless otherwise specified

SYMBOL	PARAMETER	CONDITIONS	MIN.	TYP.	MAX.	UNIT
$V_{isol}$	Peak isolation voltage from all terminals to external heatsink	SOT186 package; R.H. $\leq$ 65%; clean and dustfree	-	-	1500	V
$V_{isol}$	R.M.S. isolation voltage from all terminals to external heatsink	SOT186A package; $f = 50\text{-}60\text{ Hz}$ ; sinusoidal waveform; R.H. $\leq$ 65%; clean and dustfree	-	-	2500	V
$C_{isol}$	Capacitance from pin 2 to external heatsink	$f = 1\text{ MHz}$	-	10	-	pF

**THERMAL RESISTANCES**

SYMBOL	PARAMETER	CONDITIONS	MIN.	TYP.	MAX.	UNIT
$R_{th\ j\text{-}hs}$	Thermal resistance junction to heatsink	per diode both diodes (with heatsink compound)	-	-	6	K/W
$R_{th\ j\text{-}a}$	Thermal resistance junction to ambient	in free air	-	55	-	K/W

**ELECTRICAL CHARACTERISTICS**
 $T_j = 25\text{ °C}$  unless otherwise specified

SYMBOL	PARAMETER	CONDITIONS	MIN.	TYP.	MAX.	UNIT
$V_F$	Forward voltage	$I_F = 10\text{ A}$ ; $T_j = 125\text{ °C}$ $I_F = 20\text{ A}$ ; $T_j = 125\text{ °C}$ $I_F = 20\text{ A}$	-	0.45 0.64 0.64	0.57 0.72 0.84	V V V
$I_R$	Reverse current	$V_R = V_{RWM}$	-	0.3	1.3	mA
$C_d$	Junction capacitance	$V_R = V_{RWM}$ ; $T_j = 100\text{ °C}$ $V_R = 5\text{ V}$ ; $f = 1\text{ MHz}$ ; $T_j = 25\text{ °C}$ to $125\text{ °C}$	-	22 380	35 -	mA pF

Rectifier diodes  
Schottky barrier

PBYR2045CTF, PBYR2045CTX series

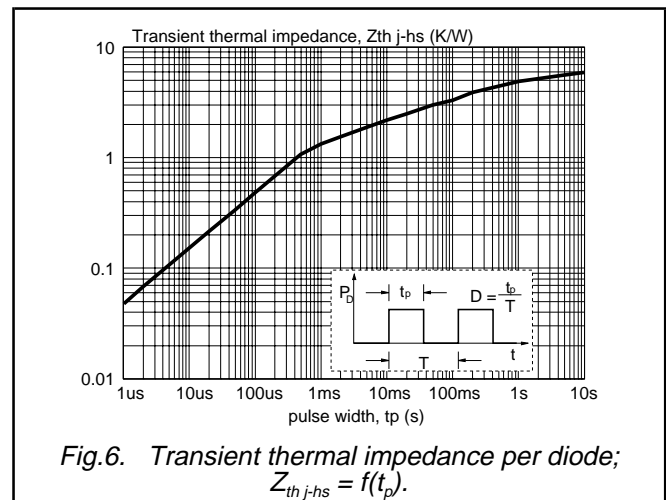
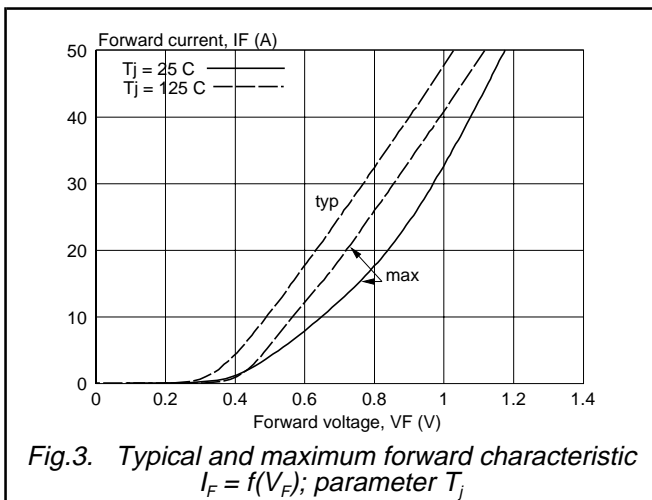
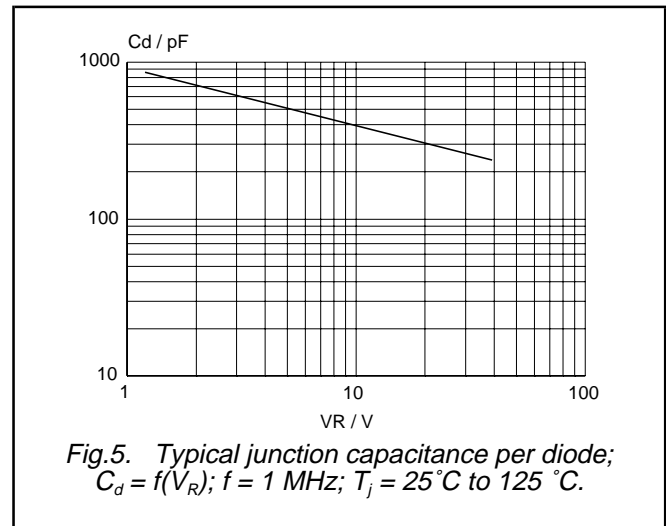
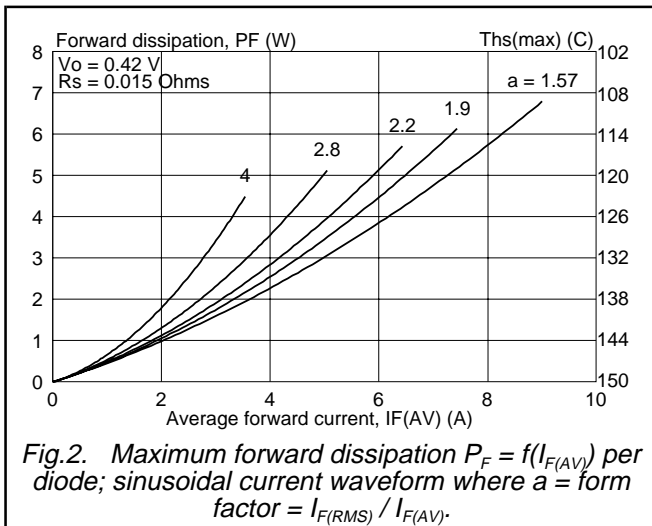
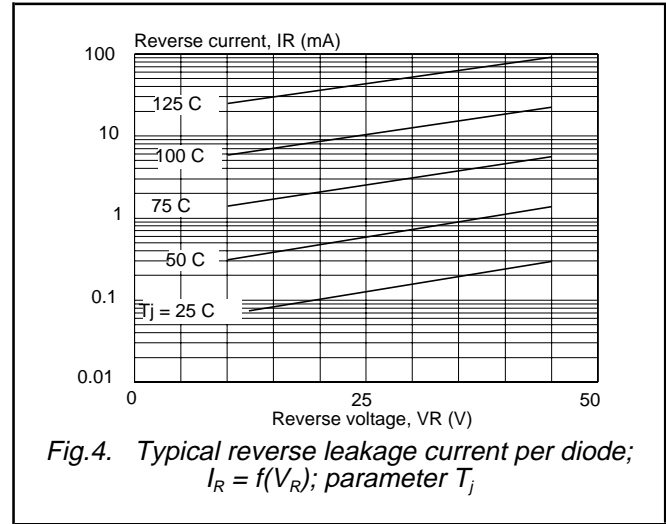
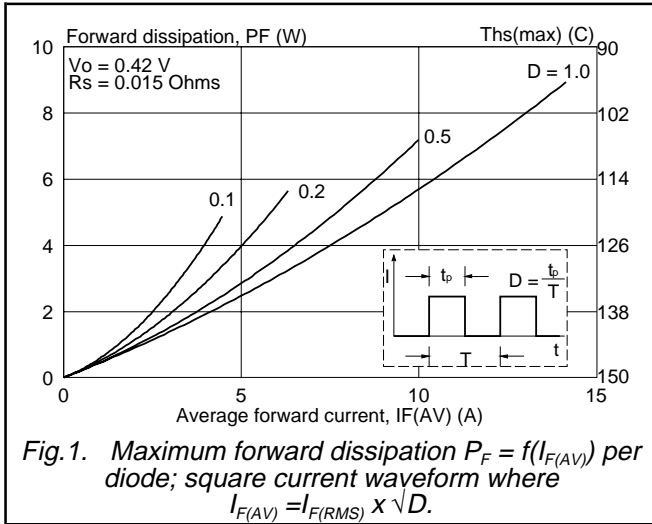

Rectifier diodes  
Schottky barrier

PBYR2045CTF, PBYR2045CTX series

**MECHANICAL DATA**

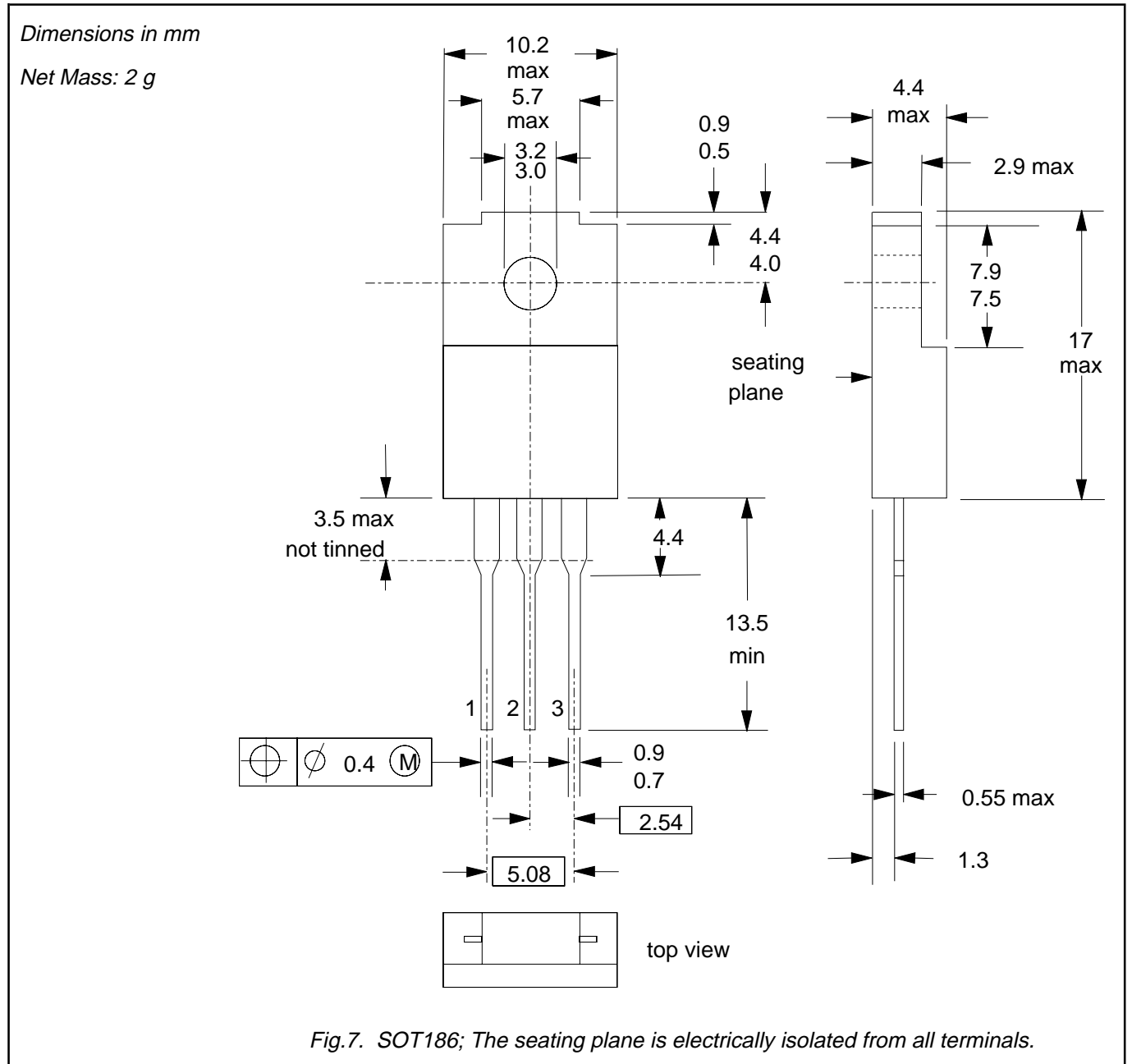

**Notes**

1. Refer to mounting instructions for F-pack envelopes.
2. Epoxy meets UL94 V0 at 1/8".

Rectifier diodes  
Schottky barrier

PBYR2045CTF, PBYR2045CTX series

**MECHANICAL DATA**

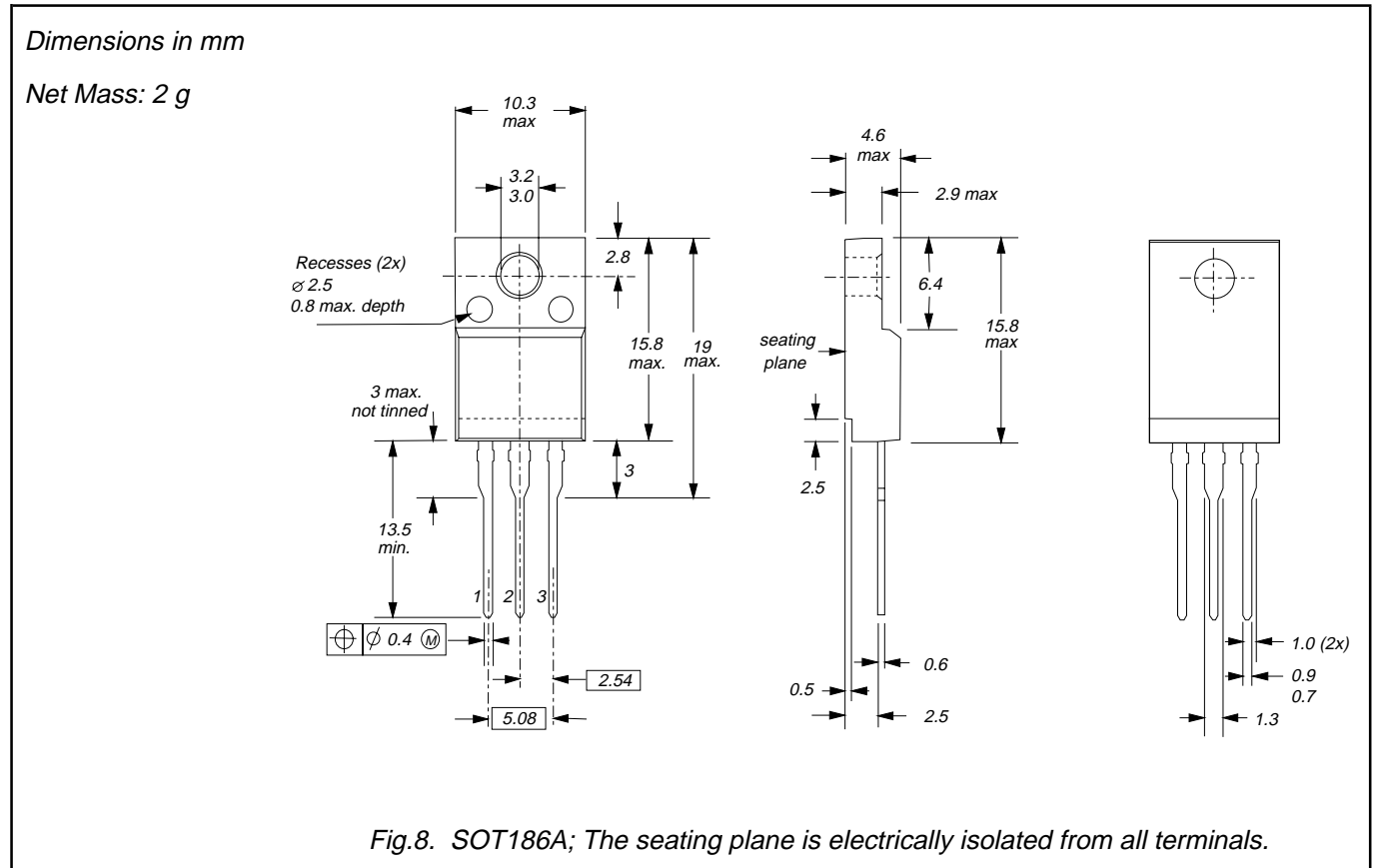

**Notes**

1. Refer to mounting instructions for F-pack envelopes.
2. Epoxy meets UL94 V0 at 1/8".

Rectifier diodes  
Schottky barrier

PBYR2045CTF, PBYR2045CTX series

## DEFINITIONS

<b>Data sheet status</b>	
Objective specification	This data sheet contains target or goal specifications for product development.
Preliminary specification	This data sheet contains preliminary data; supplementary data may be published later.
Product specification	This data sheet contains final product specifications.
<b>Limiting values</b>	
Limiting values are given in accordance with the Absolute Maximum Rating System (IEC 134). Stress above one or more of the limiting values may cause permanent damage to the device. These are stress ratings only and operation of the device at these or at any other conditions above those given in the Characteristics sections of this specification is not implied. Exposure to limiting values for extended periods may affect device reliability.	
<b>Application information</b>	
Where application information is given, it is advisory and does not form part of the specification.	
© Philips Electronics N.V. 1998	
All rights are reserved. Reproduction in whole or in part is prohibited without the prior written consent of the copyright owner.	
The information presented in this document does not form part of any quotation or contract, it is believed to be accurate and reliable and may be changed without notice. No liability will be accepted by the publisher for any consequence of its use. Publication thereof does not convey nor imply any license under patent or other industrial or intellectual property rights.	

## LIFE SUPPORT APPLICATIONS

These products are not designed for use in life support appliances, devices or systems where malfunction of these products can be reasonably expected to result in personal injury. Philips customers using or selling these products for use in such applications do so at their own risk and agree to fully indemnify Philips for any damages resulting from such improper use or sale.