

# Rectifier diode ultrafast, low switching loss

**BYC5B-600**

## FEATURES

- Extremely fast switching
- Low reverse recovery current
- Low thermal resistance
- Reduces switching losses in associated MOSFET

## SYMBOL

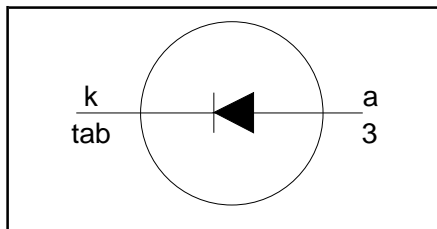

## QUICK REFERENCE DATA

$V_R = 600\text{ V}$
$V_F \leq 1.75\text{ V}$
$I_{F(AV)} = 5\text{ A}$
$t_{rr} = 19\text{ ns (typ)}$

## APPLICATIONS

- Active power factor correction
- Half-bridge lighting ballasts
- Half-bridge/ full-bridge switched mode power supplies.

The BYC5B-600 is supplied in the SOT404 surface mounting package.

## PINNING

PIN	DESCRIPTION
1	no connection
2	cathode <sup>1</sup>
3	anode
tab	cathode

## SOT404

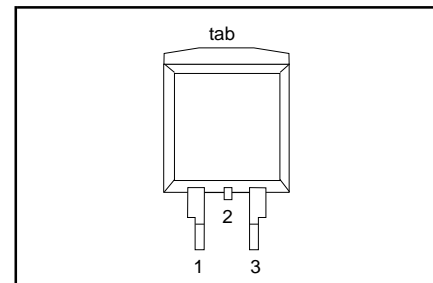

## LIMITING VALUES

Limiting values in accordance with the Absolute Maximum System (IEC 134).

SYMBOL	PARAMETER	CONDITIONS	MIN.	MAX.	UNIT
$V_{RRM}$	Peak repetitive reverse voltage		-	600	V
$V_{RWM}$	Crest working reverse voltage		-	600	V
$V_R$	Continuous reverse voltage	$T_{mb} \leq 110\text{ }^\circ\text{C}$	-	500	V
$I_{F(AV)}$	Average forward current	$\delta = 0.5$ ; with reapplied $V_{RRM(max)}$ ; $T_{mb} \leq 89\text{ }^\circ\text{C}^1$	-	5	A
$I_{FRM}$	Repetitive peak forward current	$\delta = 0.5$ ; with reapplied $V_{RRM(max)}$ ; $T_{mb} \leq 89\text{ }^\circ\text{C}^1$	-	10	A
$I_{FSM}$	Non-repetitive peak forward current.	$t = 10\text{ ms}$	-	40	A
		$t = 8.3\text{ ms}$	-	44	A
		sinusoidal; $T_j = 150\text{ }^\circ\text{C}$ prior to surge with reapplied $V_{RWM(max)}$			
$T_{stg}$	Storage temperature		-40	150	$^\circ\text{C}$
$T_j$	Operating junction temperature		-	150	$^\circ\text{C}$

## THERMAL RESISTANCES

SYMBOL	PARAMETER	CONDITIONS	MIN.	TYP.	MAX.	UNIT
$R_{th\ j-mb}$	Thermal resistance junction to mounting base		-	-	2.5	K/W
$R_{th\ j-a}$	Thermal resistance junction to ambient	minimum footprint, FR4 board	-	50	-	K/W

<sup>1</sup> it is not possible to make connection to pin 2 of the SOT404 package

**Rectifier diode  
ultrafast, low switching loss**

**BYC5B-600**

**ELECTRICAL CHARACTERISTICS**

$T_j = 25\text{ }^\circ\text{C}$  unless otherwise stated

SYMBOL	PARAMETER	CONDITIONS	MIN.	TYP.	MAX.	UNIT
$V_F$	Forward voltage	$I_F = 5\text{ A}; T_j = 150\text{ }^\circ\text{C}$	-	1.4	1.75	V
		$I_F = 10\text{ A}; T_j = 150\text{ }^\circ\text{C}$	-	1.75	2.2	V
$I_R$	Reverse current	$I_F = 5\text{ A}; V_R = 600\text{ V}$	-	2.0	2.8	V
		$V_R = 500\text{ V}; T_j = 100\text{ }^\circ\text{C}$	-	9	100	$\mu\text{A}$
$t_{rr}$	Reverse recovery time	$I_F = 5\text{ A}; dI_F/dt = 500\text{ A}/\mu\text{s}; V_R = 400\text{ V}$	-	0.9	3.0	ns
$t_{rr}$	Reverse recovery time	$I_F = 5\text{ A}; dI_F/dt = 500\text{ A}/\mu\text{s}; V_R = 400\text{ V}; T_j = 125\text{ }^\circ\text{C}$	-	19	-	ns
$I_{rrm}$	Peak reverse recovery current	$I_F = 5\text{ A}; V_R = 400\text{ V}; dI_F/dt = 500\text{ A}/\mu\text{s}; T_j = 125\text{ }^\circ\text{C}$	-	25	30	ns
$V_{fr}$	Forward recovery voltage	$I_F = 10\text{ A}; dI_F/dt = 100\text{ A}/\mu\text{s}$	-	8	11	A
			-	9	11	V

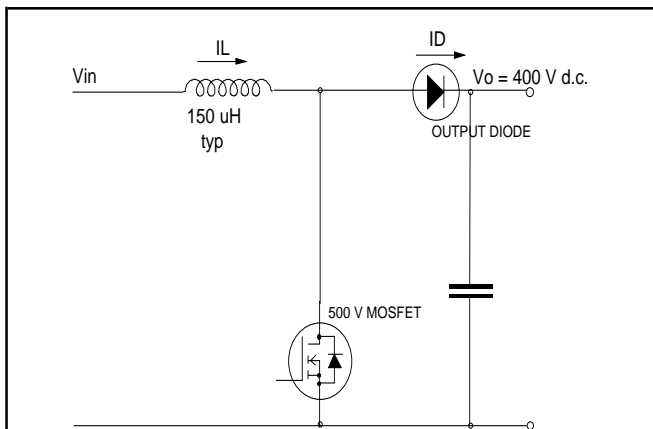

Fig.1. Typical application, output rectifier in boost converter power factor correction circuit. Continuous conduction mode, where the transistor turns on whilst forward current is still flowing in the diode.

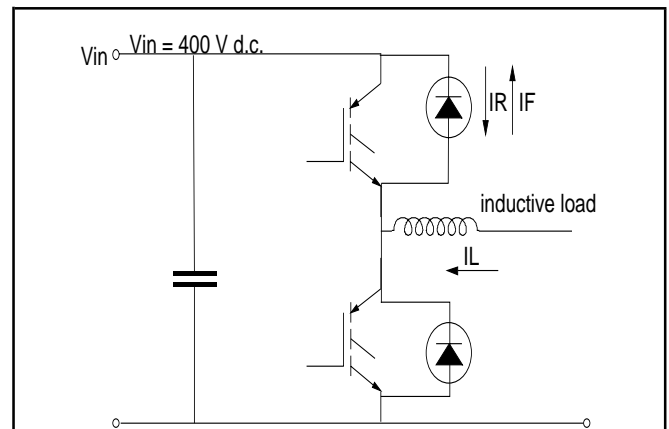
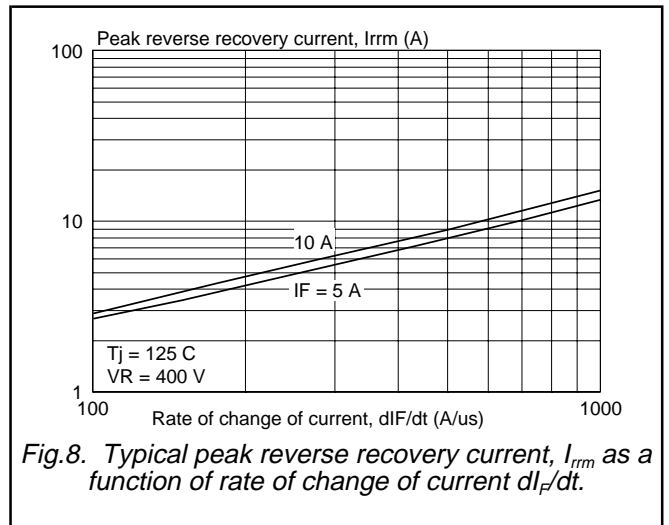
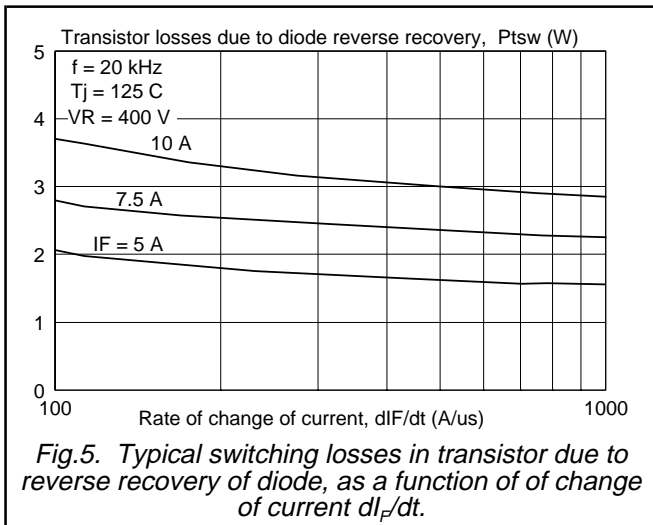
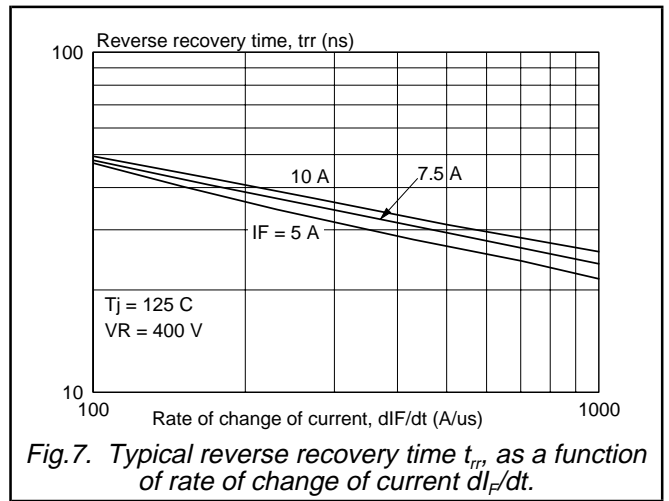
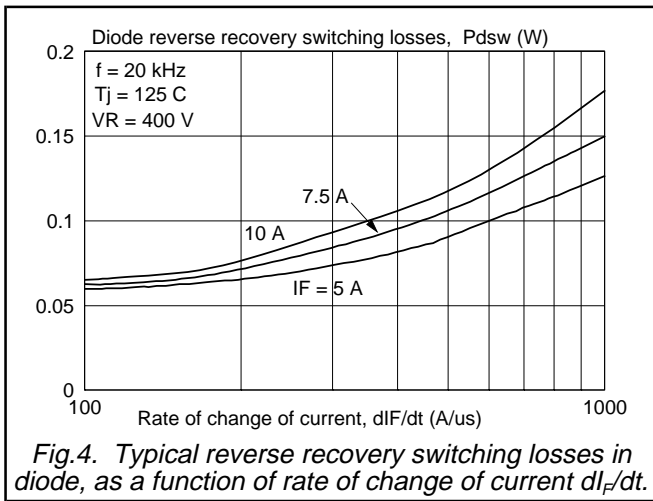
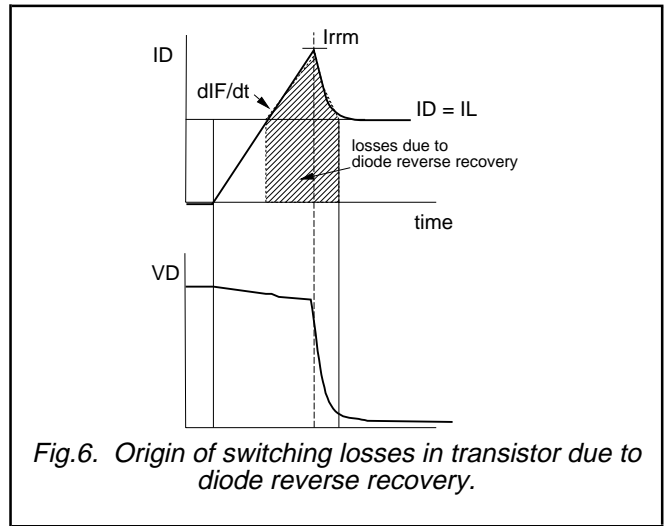
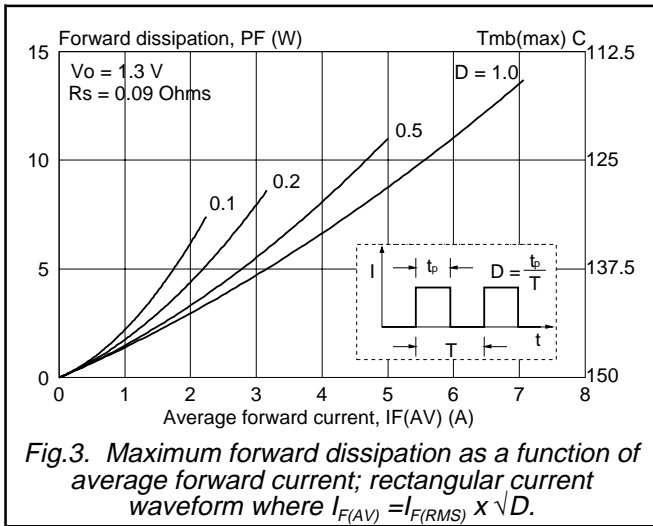

Fig.2. Typical application, freewheeling diode in half bridge converter. Continuous conduction mode, where each transistor turns on whilst forward current is still flowing in the other bridge leg diode.

Rectifier diode  
ultrafast, low switching loss

BYC5B-600



Rectifier diode  
ultrafast, low switching loss

BYC5B-600

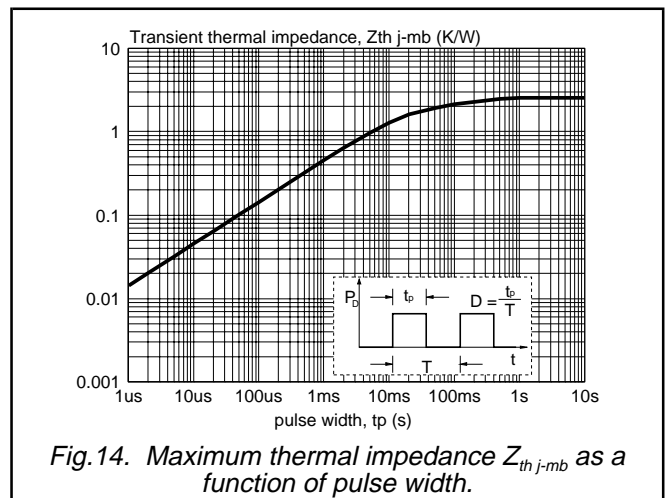
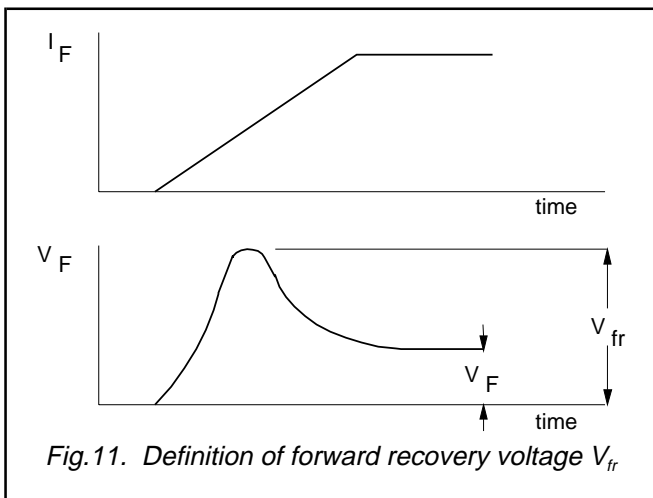
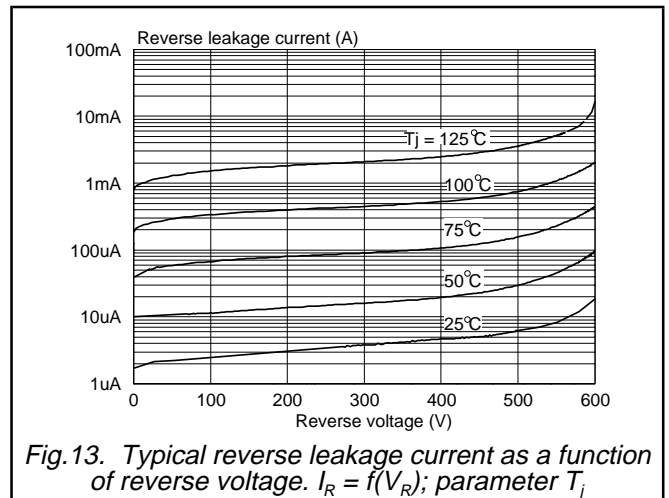
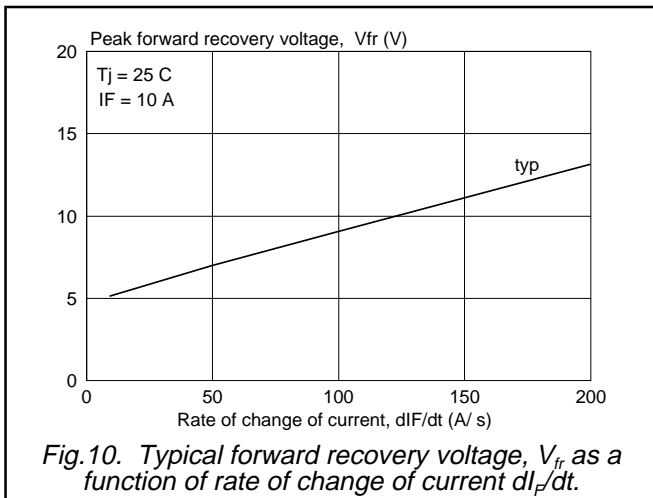
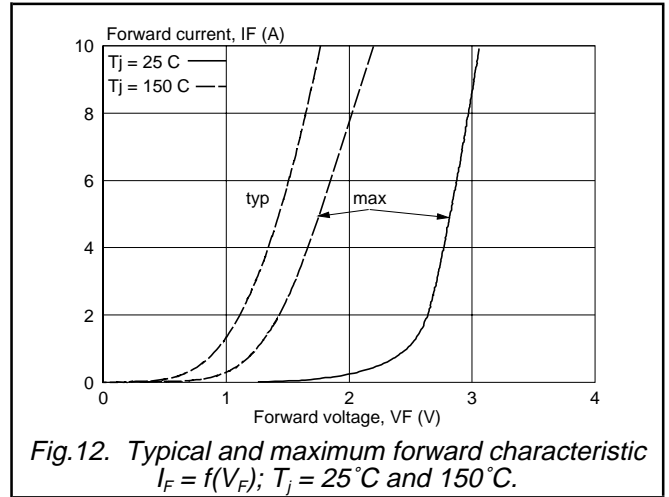
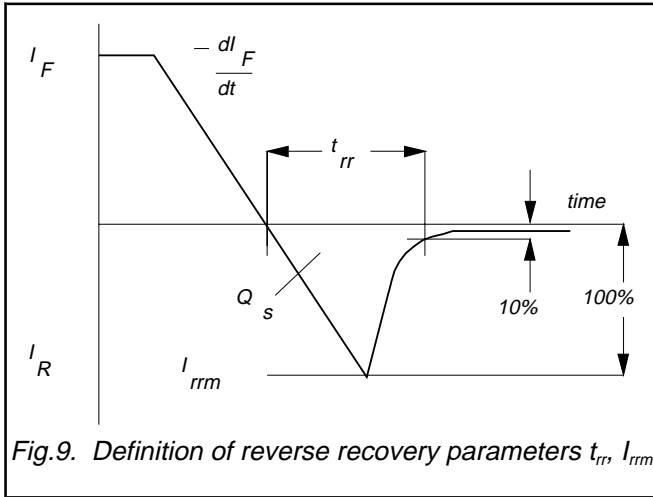

Rectifier diode  
ultrafast, low switching loss

BYC5B-600

**MECHANICAL DATA**

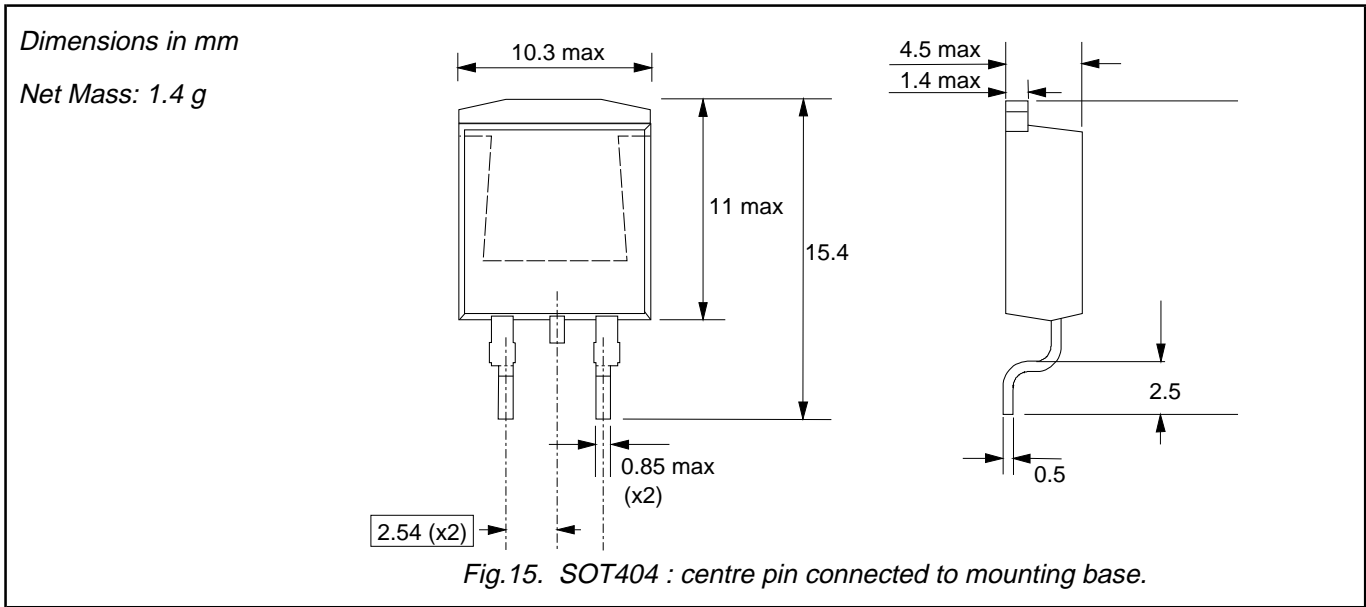

**MOUNTING INSTRUCTIONS**

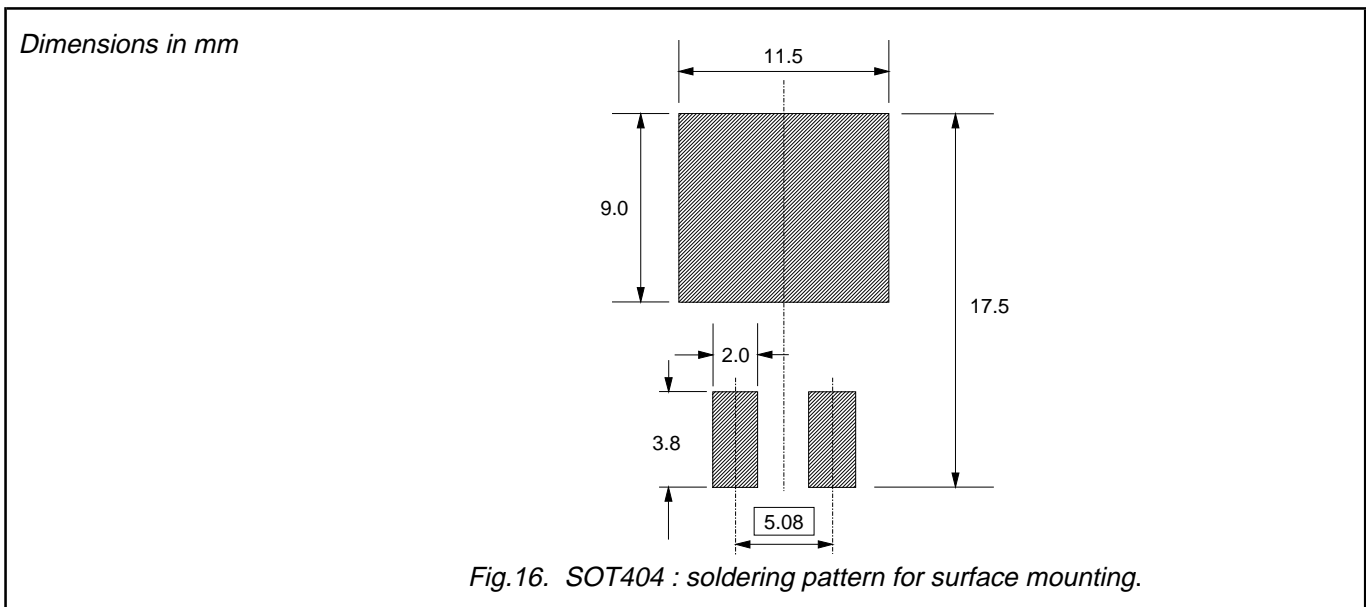

**Notes**

1. Epoxy meets UL94 V0 at 1/8".

---

**Rectifier diode**  
**ultrafast, low switching loss**

---

BYC5B-600

**DEFINITIONS**

<b>Data sheet status</b>	
Objective specification	This data sheet contains target or goal specifications for product development.
Preliminary specification	This data sheet contains preliminary data; supplementary data may be published later.
Product specification	This data sheet contains final product specifications.
<b>Limiting values</b>	
Limiting values are given in accordance with the Absolute Maximum Rating System (IEC 134). Stress above one or more of the limiting values may cause permanent damage to the device. These are stress ratings only and operation of the device at these or at any other conditions above those given in the Characteristics sections of this specification is not implied. Exposure to limiting values for extended periods may affect device reliability.	
<b>Application information</b>	
Where application information is given, it is advisory and does not form part of the specification.	
<b>© Philips Electronics N.V. 1998</b>	
All rights are reserved. Reproduction in whole or in part is prohibited without the prior written consent of the copyright owner.	
The information presented in this document does not form part of any quotation or contract, it is believed to be accurate and reliable and may be changed without notice. No liability will be accepted by the publisher for any consequence of its use. Publication thereof does not convey nor imply any license under patent or other industrial or intellectual property rights.	

**LIFE SUPPORT APPLICATIONS**

These products are not designed for use in life support appliances, devices or systems where malfunction of these products can be reasonably expected to result in personal injury. Philips customers using or selling these products for use in such applications do so at their own risk and agree to fully indemnify Philips for any damages resulting from such improper use or sale.