

DATA SHEET

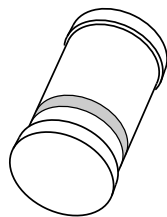

BYD47 series Fast soft-recovery rectifiers

Product specification
Supersedes data of November 1994
File under Discrete Semiconductors, SC01

1996 Jun 05

Fast soft-recovery rectifiers

BYD47 series

FEATURES

- Glass passivated
- High maximum operating temperature
- Low leakage current
- Excellent stability
- Shipped in 8 mm embossed tape
- Smallest surface mount rectifier outline.

DESCRIPTION

Cavity free cylindrical glass SOD87 package through Implotec™(1) technology. This package is

hermetically sealed and fatigue free as coefficients of expansion of all used parts are matched.

(1) Implotec is a trademark of Philips.

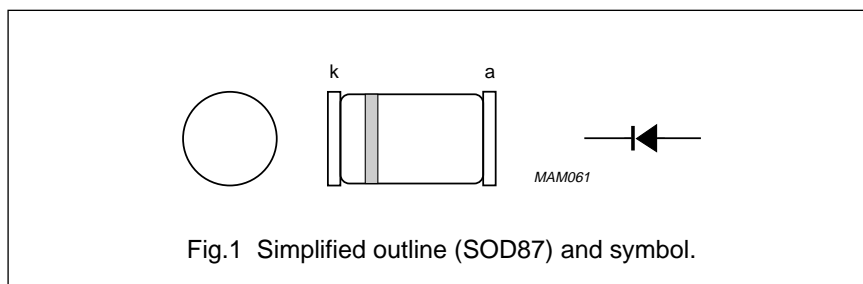

Fig.1 Simplified outline (SOD87) and symbol.

LIMITING VALUES

In accordance with the Absolute Maximum Rating System (IEC 134).

SYMBOL	PARAMETER	CONDITIONS	MIN.	MAX.	UNIT
V_{RSM}	non-repetitive peak reverse voltage				
	BYD47-16		–	1700	V
	BYD47-18		–	1900	V
	BYD47-20		–	2100	V
V_{RRM}	repetitive peak reverse voltage				
	BYD47-16		–	1600	V
	BYD47-18		–	1800	V
	BYD47-20		–	2000	V
$I_{F(AV)}$	average forward current	$T_{tp} = 105\text{ °C}$; see Fig. 2; averaged over any 20 ms period; see also Fig. 6	–	0.80	A
$I_{F(AV)}$	average forward current	$T_{amb} = 25\text{ °C}$; PCB mounting (see Fig.11); see Fig. 3; averaged over any 20 ms period; see also Fig. 6	–	0.34	A
I_{FRM}	repetitive peak forward current	$T_{tp} = 85\text{ °C}$; see Fig. 4	–	8.0	A
		$T_{amb} = 65\text{ °C}$; see Fig. 5	–	2.8	A
I_{FSM}	non-repetitive peak forward current	$t = 10\text{ ms}$ half sine wave; $T_j = T_{jmax}$ prior to surge; $V_R = V_{RRMmax}$	–	10	A
T_{stg}	storage temperature		–65	+175	°C
T_j	junction temperature	see Fig. 7	–65	+175	°C

Fast soft-recovery rectifiers

BYD47 series

ELECTRICAL CHARACTERISTICS

$T_j = 25\text{ }^\circ\text{C}$ unless otherwise specified.

SYMBOL	PARAMETER	CONDITIONS	TYP.	MAX.	UNIT
V_F	forward voltage	$I_F = 1\text{ A}$; $T_j = T_{j\text{ max}}$; see Fig. 8	–	2.05	V
		$I_F = 1\text{ A}$; see Fig. 8	–	2.40	V
I_R	reverse current	$V_R = V_{RRM\text{ max}}$; see Fig. 9	–	5	μA
		$V_R = V_{RRM\text{ max}}$; $T_j = 125\text{ }^\circ\text{C}$; see Fig. 9	–	50	μA
t_{rr}	reverse recovery time	when switched from $I_F = 0.5\text{ A}$ to $I_R = 1\text{ A}$; measured at $I_R = 0.25\text{ A}$; see Fig. 12	–	300	ns
C_d	diode capacitance	$f = 1\text{ MHz}$; $V_R = 0\text{ V}$; see Fig. 10	15	–	pF
$\left \frac{dI_R}{dt} \right $	maximum slope of reverse recovery current	when switched from $I_F = 1\text{ A}$ to $V_R \geq 30\text{ V}$ and $dI_F/dt = -1\text{ A}/\mu\text{s}$; see Fig.13	–	5	$\text{A}/\mu\text{s}$

THERMAL CHARACTERISTICS

SYMBOL	PARAMETER	CONDITIONS	VALUE	UNIT
$R_{th\ j\text{-tp}}$	thermal resistance from junction to tie-point		30	K/W
$R_{th\ j\text{-a}}$	thermal resistance from junction to ambient	note 1	150	K/W

Note

1. Device mounted on an epoxy-glass printed-circuit board, 1.5 mm thick; thickness of Cu-layer $\geq 40\text{ }\mu\text{m}$, see Fig.11. For more information please refer to the 'General Part of Handbook SC01.'

Fast soft-recovery rectifiers

BYD47 series

GRAPHICAL DATA

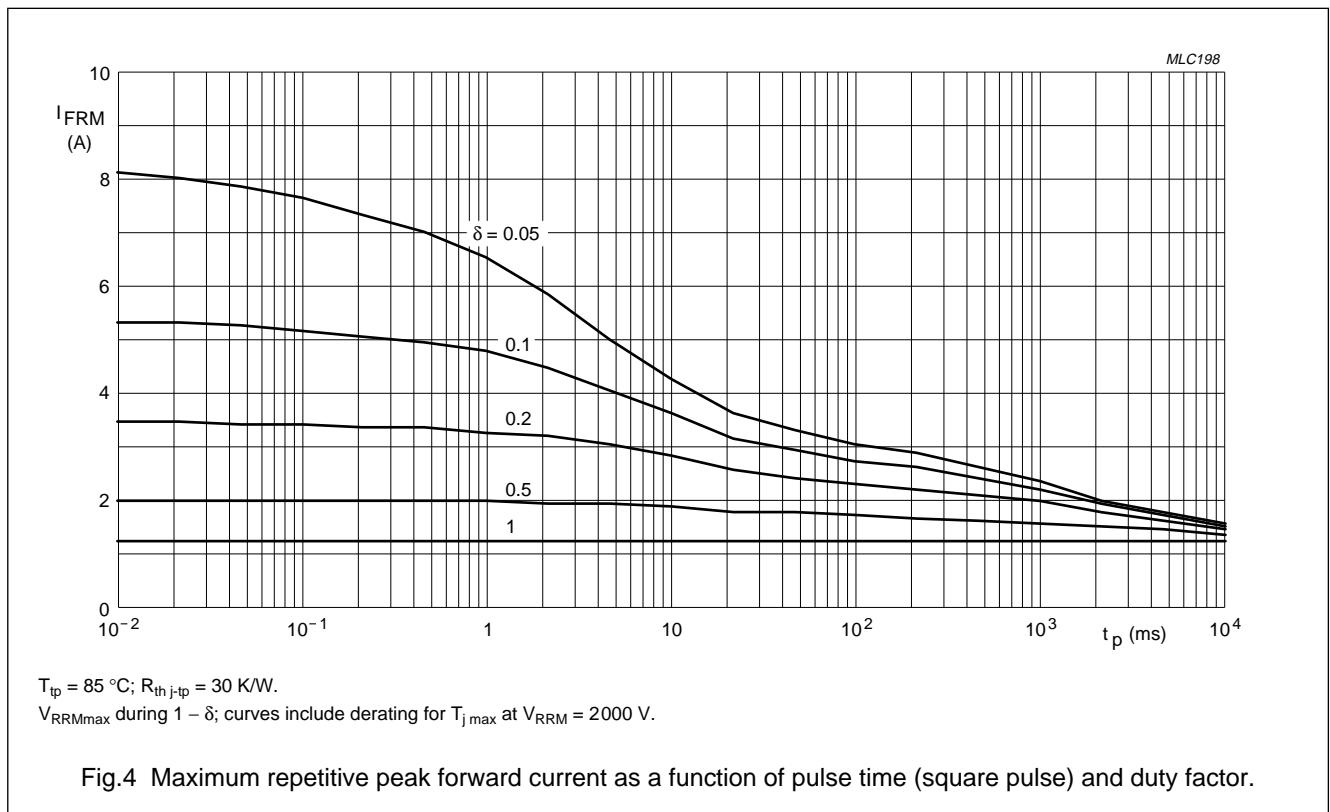
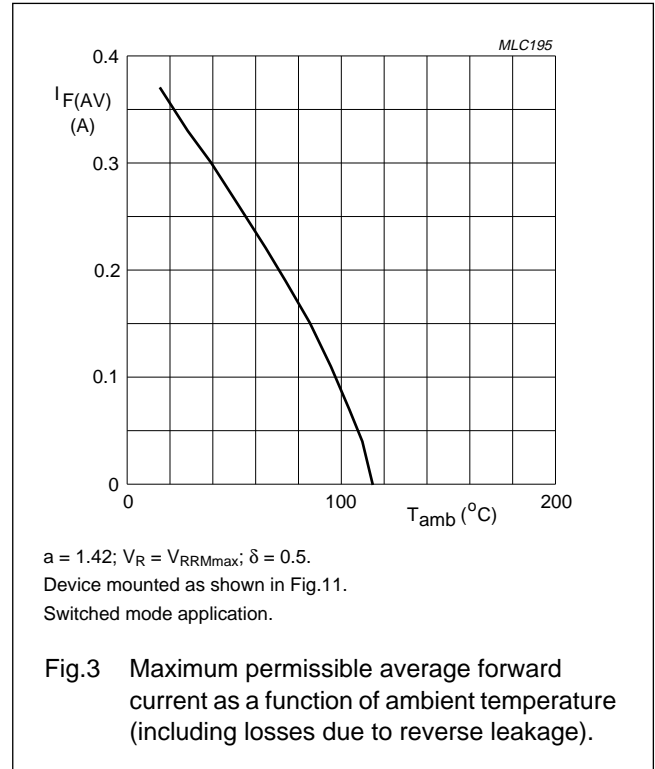
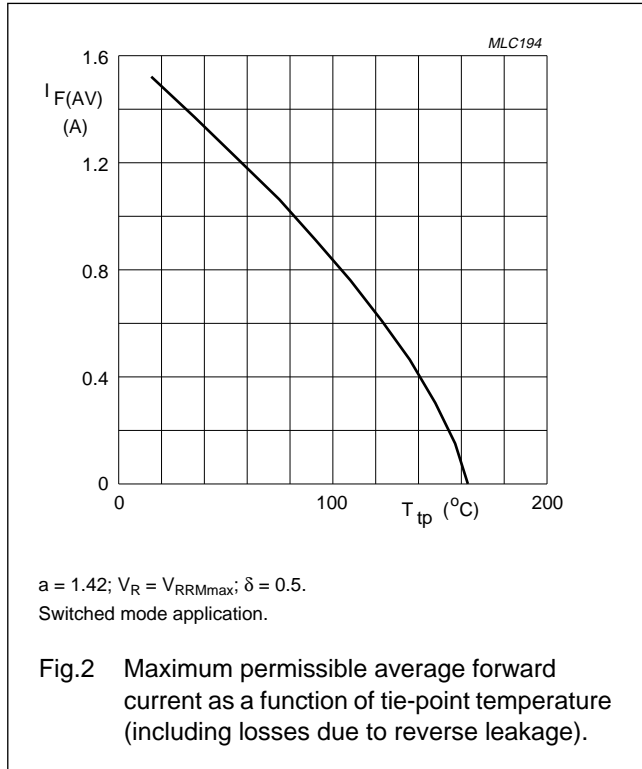

Fast soft-recovery rectifiers

BYD47 series

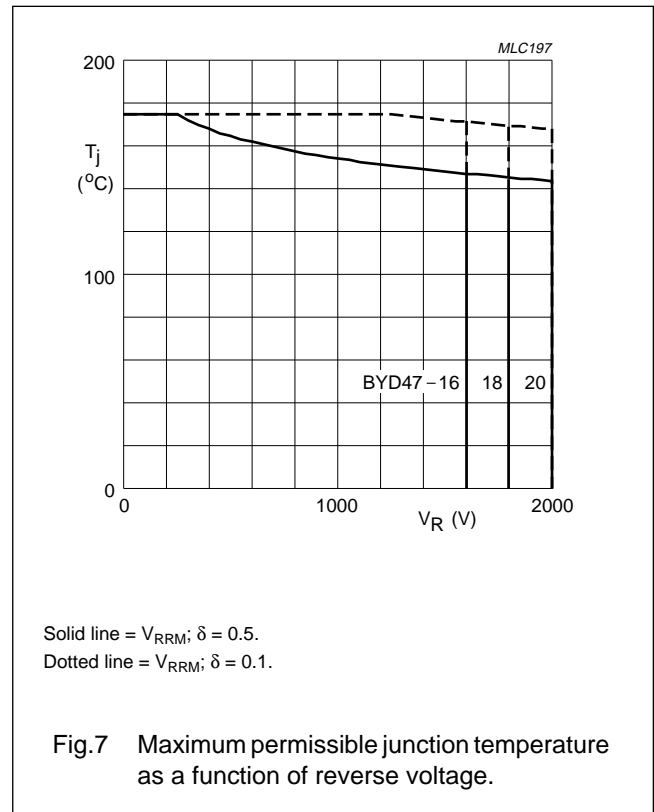
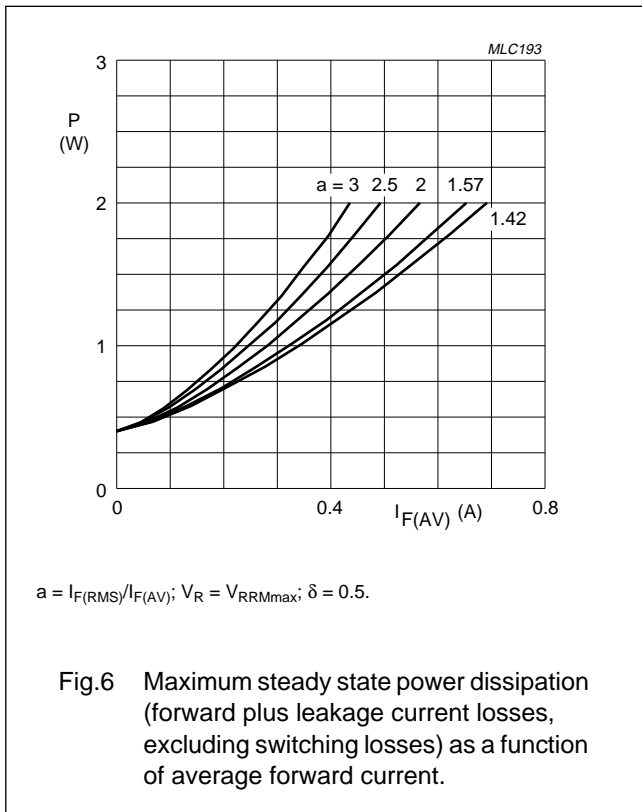
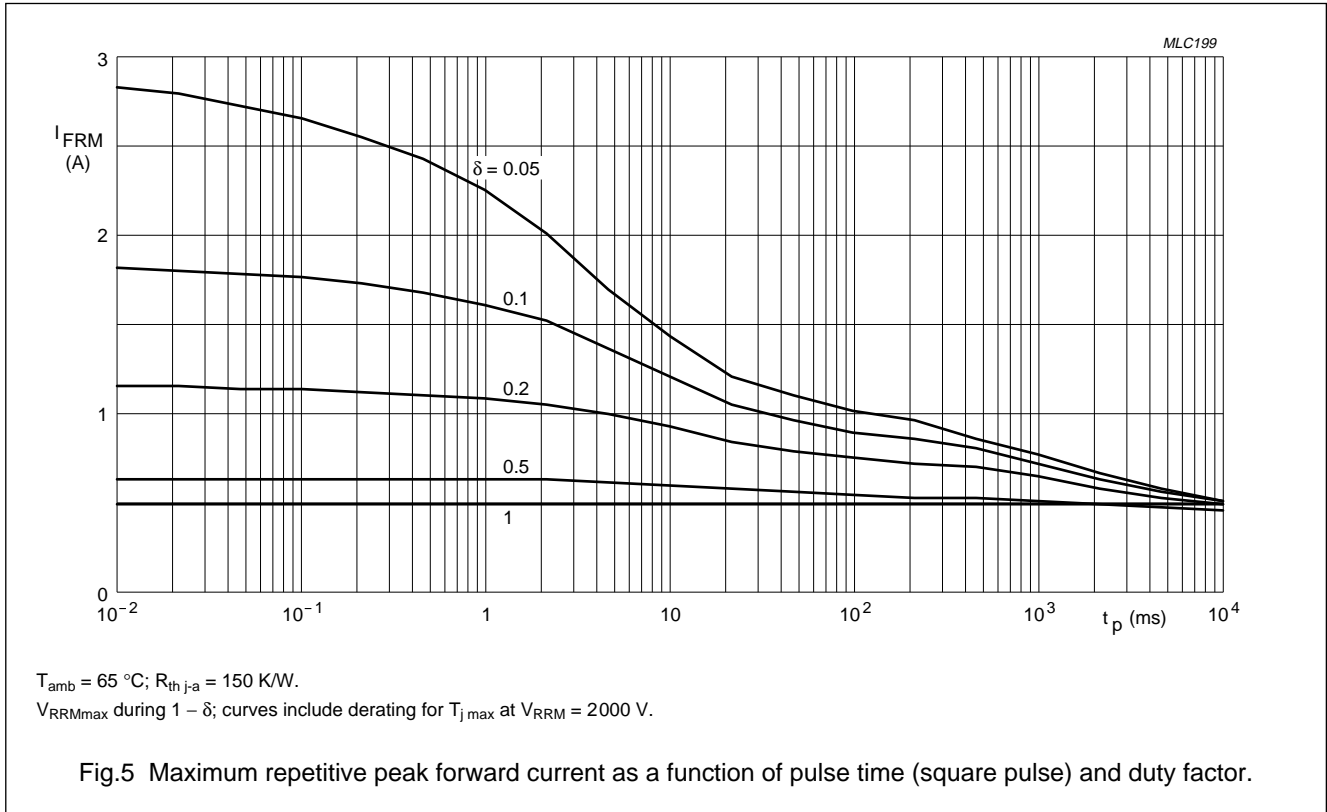

Fast soft-recovery rectifiers

BYD47 series

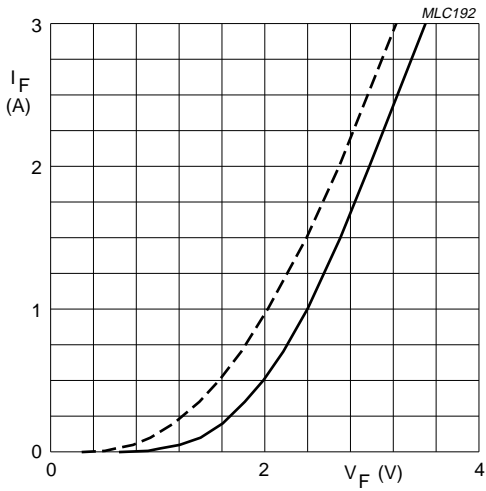

Dotted line: $T_j = 175\text{ }^\circ\text{C}$.
 Solid line: $T_j = 25\text{ }^\circ\text{C}$.

Fig.8 Forward current as a function of forward voltage; maximum values.

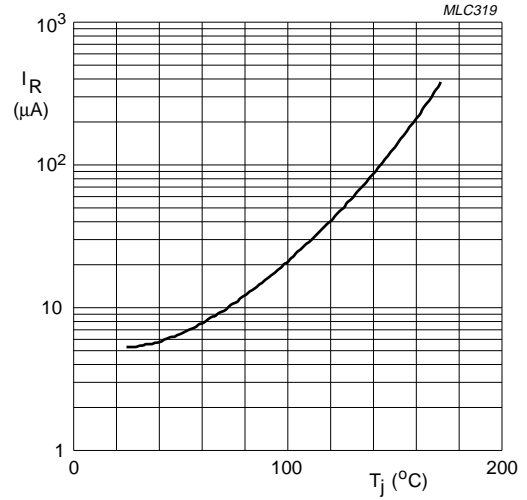

$V_R = V_{RRMmax}$.

Fig.9 Reverse current as a function of junction temperature; maximum values.

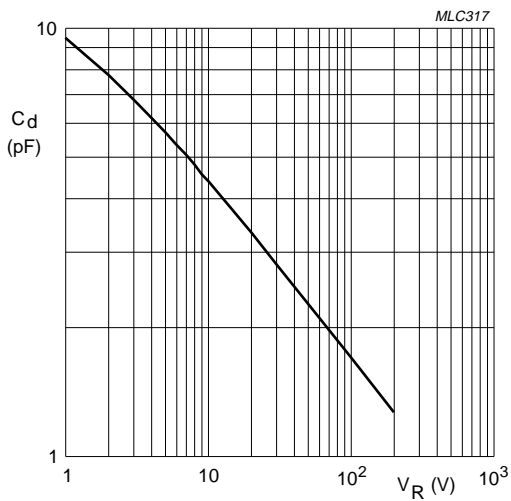

$f = 1\text{ MHz}$; $T_j = 25\text{ }^\circ\text{C}$.

Fig.10 Diode capacitance as a function of reverse voltage; typical values.

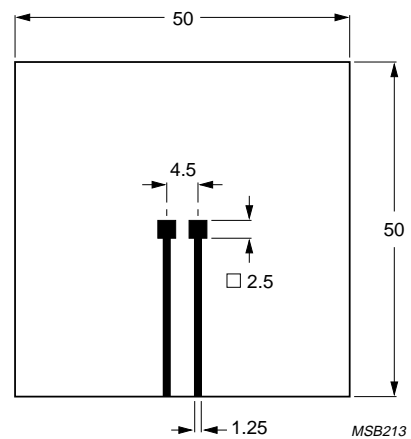

Dimensions in mm.

Fig.11 Printed-circuit board for surface mounting.

Fast soft-recovery rectifiers

BYD47 series

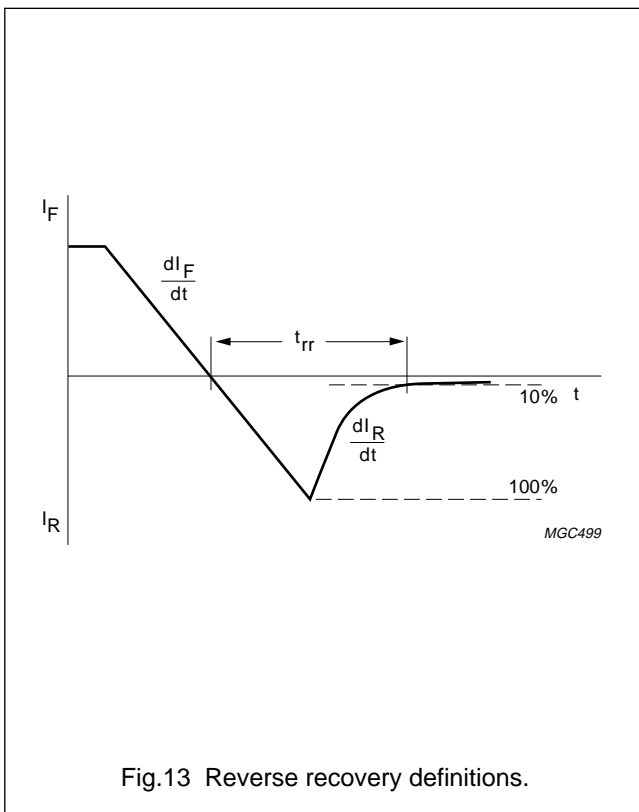
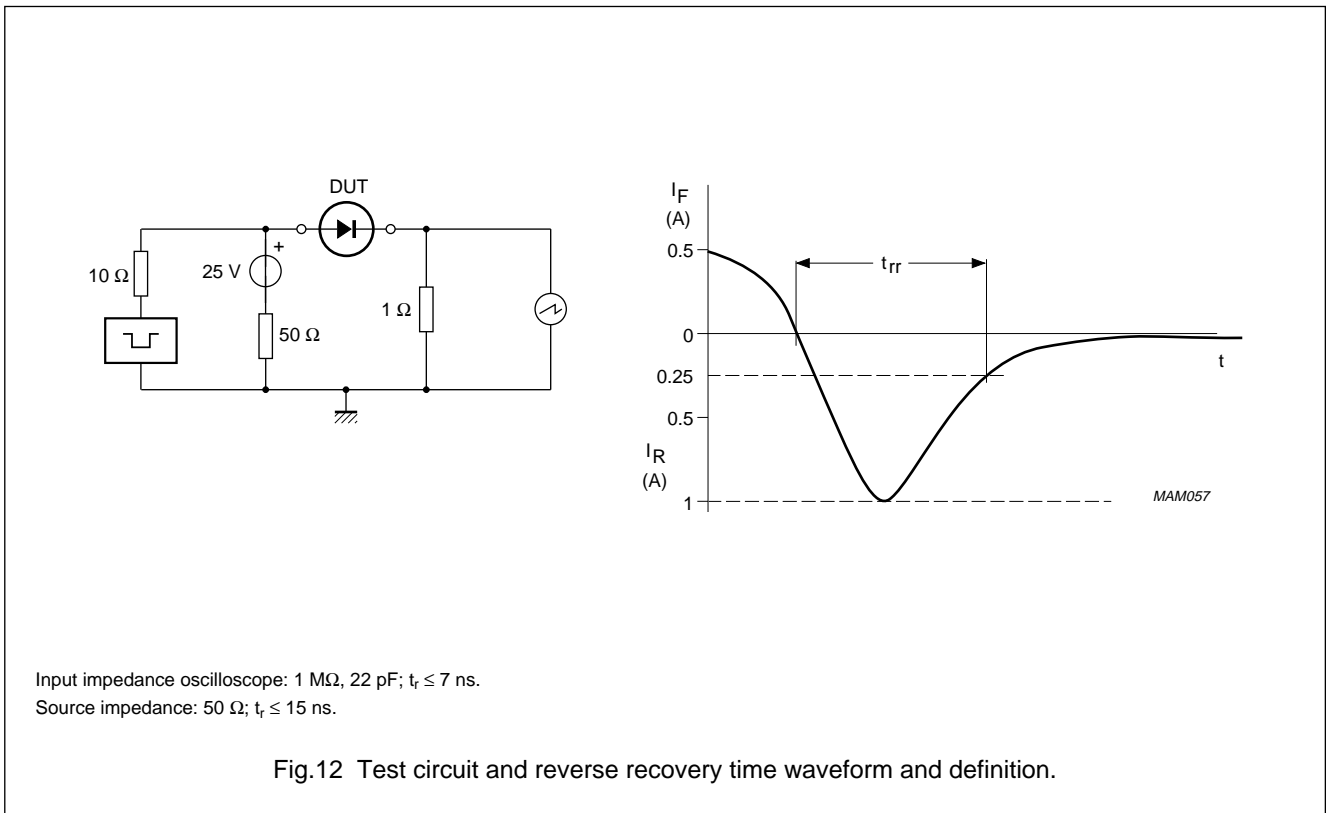

Fast soft-recovery rectifiers

BYD47 series

PACKAGE OUTLINE

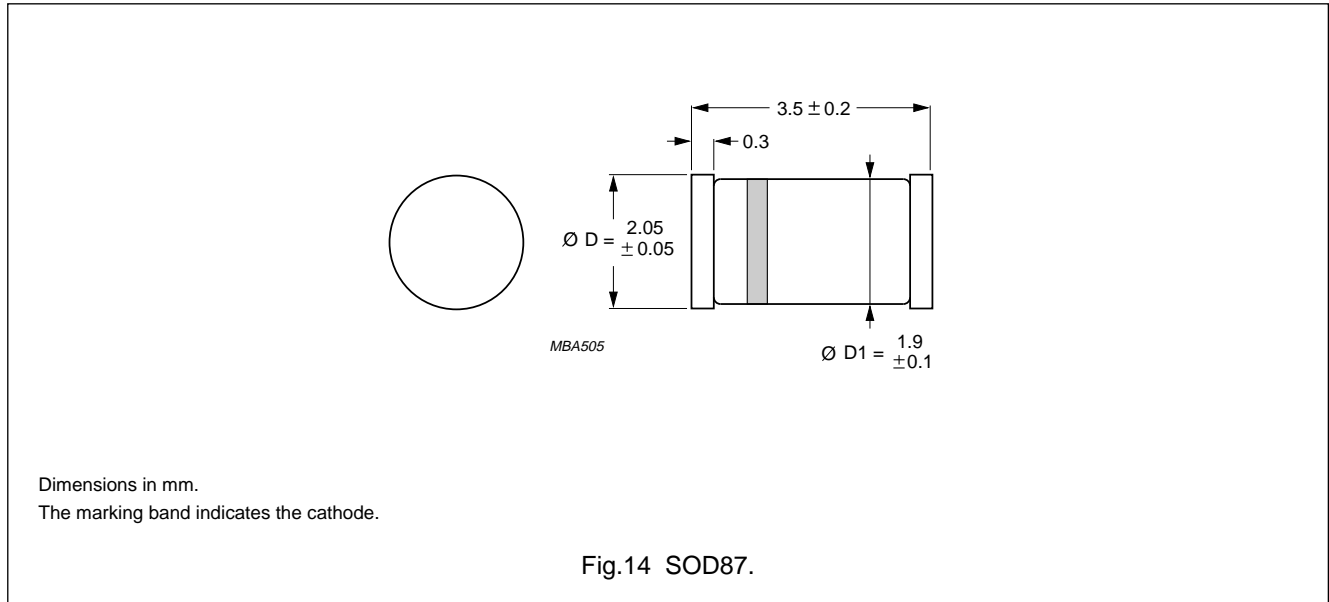

DEFINITIONS

Data Sheet Status	
Objective specification	This data sheet contains target or goal specifications for product development.
Preliminary specification	This data sheet contains preliminary data; supplementary data may be published later.
Product specification	This data sheet contains final product specifications.
Limiting values	
Limiting values given are in accordance with the Absolute Maximum Rating System (IEC 134). Stress above one or more of the limiting values may cause permanent damage to the device. These are stress ratings only and operation of the device at these or at any other conditions above those given in the Characteristics sections of the specification is not implied. Exposure to limiting values for extended periods may affect device reliability.	
Application information	
Where application information is given, it is advisory and does not form part of the specification.	

LIFE SUPPORT APPLICATIONS

These products are not designed for use in life support appliances, devices, or systems where malfunction of these products can reasonably be expected to result in personal injury. Philips customers using or selling these products for use in such applications do so at their own risk and agree to fully indemnify Philips for any damages resulting from such improper use or sale.