

DATA SHEET

UBA1702; UBA1702A Line interrupter driver and ringer

Product specification
Supersedes data of 1996 Jan 09
File under Integrated Circuits, IC03

1997 Sep 29

Line interrupter driver and ringer**UBA1702; UBA1702A****FEATURES****Speech part**

- Driver for the line interrupter that can be either a PMOST when UBA1702 is used or a PNP when UBA1702A is used
- Adjustable over-current protection
- Adjustable over-voltage protection for transmission circuit
- Adjustable mute (dialling mode voltage; DMO or NSA)
- Adjustable current loop detection (hook switch status)
- Microcontroller supply
- Provision for electronic hook switch.

Ringer part

- Over-voltage protection
- Ringer frequency output for frequency discrimination
- Adjustable ringer threshold for piezo-driver enable
- Three bits ringer volume control
- Bridge-tied-load (BTL) output stage for piezo transducer
- Fast start-up microcontroller supply.

Miscellaneous

- Separated ground pins for transmission circuit interface and control signals (e.g. for TEA1064A)
- Possibility to supply the microcontroller with an external voltage source.

APPLICATIONS

- Telephone sets with software controlled ringer function
- Telephone sets with electronic hook switch.

GENERAL DESCRIPTION

The UBA1702; UBA1702A performs the high voltage interface and ringer functions of the corded analog telephone set in close cooperation with a microcontroller and transmission circuit.

The UBA1702; UBA1702A incorporates several protections, a driver for the line interrupter and a ringer. Because of the practical division of functions between the microcontroller, the transmission circuit and the UBA1702; UBA1702A, it is possible to have a higher integration level thereby reducing significantly the number of discrete components in a telephone set.

ORDERING INFORMATION

TYPE NUMBER	PACKAGE		
	NAME	DESCRIPTION	VERSION
UBA1702	DIP28	plastic dual in-line package; 28 leads (600 mil)	SOT117-1
UBA1702A	DIP28	plastic dual in-line package; 28 leads (600 mil)	SOT117-1
UBA1702T	SO28	plastic small outline package; 28 leads; body width 7.5 mm	SOT136-1
UBA1702AT	SO28	plastic small outline package; 28 leads; body width 7.5 mm	SOT136-1

Line interrupter driver and ringer

UBA1702; UBA1702A

QUICK REFERENCE DATA

Speech part: $I_{line} = 20 \text{ mA}$; DPI = LOW; $T_{amb} = 25 \text{ }^\circ\text{C}$; $V_{EE} = 0 \text{ V}$; unless otherwise specified.

Ringer part: $V_{line(rms)} = 45 \text{ V}$; $f = 25 \text{ Hz}$; using an RC combination of $2.2 \text{ k}\Omega$ and 820 nF and a diode bridge between the line and the RPI input.

SYMBOL	PARAMETER	CONDITIONS	MIN.	TYP.	MAX.	UNIT
Speech part						
SWITCH DRIVER AND REFERENCES (PINS SDI, SDO, EHI AND DPI); UBA1702A ONLY						
R_{SDO}	resistance between pins SDO and V_{EE}		–	2.2	–	$\text{k}\Omega$
SWITCH DRIVER AND REFERENCES (PINS SDI, SDO, EHI AND DPI); UBA1702 AND UBA1702A						
$R_{SDI-SDO}$	resistance between pins SDI and SDO	$V_{SDI} - V_{SDO} < 12 \text{ V}$	–	1.1	–	$\text{M}\Omega$
R_{SDI}	resistance between pins SDI and V_{EE}	$V_{SDI} = 240 \text{ V}$; DPI = HIGH	5	–	–	$\text{M}\Omega$
MUTE SWITCH AND ADJUSTABLE PROTECTION ZENER VOLTAGE (PINS MSI, MSA AND ZPA)						
$V_{SPO(M)}$	adjustable mute voltage referenced to V_{EE}	MSI = HIGH; MSA open-circuit	–	2.7	3	V
$V_{SPO(Z)}$	adjustable zener voltage referenced to V_{EE}	MSI = LOW; ZPA open-circuit	11	12	13	V
CURRENT MANAGEMENT (PINS SPI, SPO, CDA, CLA AND CDO)						
$I_{SPI(lim)}$	current limitation (pin SPI)	CLA shorted to V_{EE}	–	120	–	mA
$I_{SPI(det)}$	current detection (pin SPI)	CDA open-circuit	2	3	4	mA
MICROCONTROLLER SUPPLY (V_{DD} AND V_{BB})						
V_{DD}	supply output voltage referenced to V_{SS}	$V_{BB} > 3.7 \text{ V}$; $I_{DD} = -1 \text{ mA}$	3.0	3.3	3.6	V
Ringer part						
PROTECTION (PIN RPI)						
$I_{RPI(max)}$	maximum input current		70	–	–	mA
RINGER THRESHOLD AND FREQUENCY DETECTION (PINS V_{RR} , RTA AND RFO)						
$V_{RR(th)}$	ringer supply threshold voltage referenced to V_{SS}	RTA open-circuit	–	11	–	V
VOLUME CONTROL (PINS RV0, RV1 AND RV2)						
ΔG_s	step resolution	(RV2, RV1, RV0) from (0, 0, 0) to (1, 1, 0); note 1	–	6	–	dB
ΔG_{ls}	last step resolution	(RV2, RV1, RV0) from (1, 1, 0) to (1, 1, 1); note 2	–	9.5	12	dB
RINGER MELODY INPUT AND PIEZO DRIVER (PINS RMI, ROA AND ROB)						
$V_{o(max\ p-p)}$	maximum output voltage between pins ROA and ROB (peak-to-peak value)	RV2 = 1; RV1 = 1; RV0 = 1	–	28.7	32	V

Notes

1. Independent of V_{RR} if greater than 10 V.
2. Without piezo transducer, dependent on V_{RR} .

Line interrupter driver and ringer

UBA1702; UBA1702A

BLOCK DIAGRAM

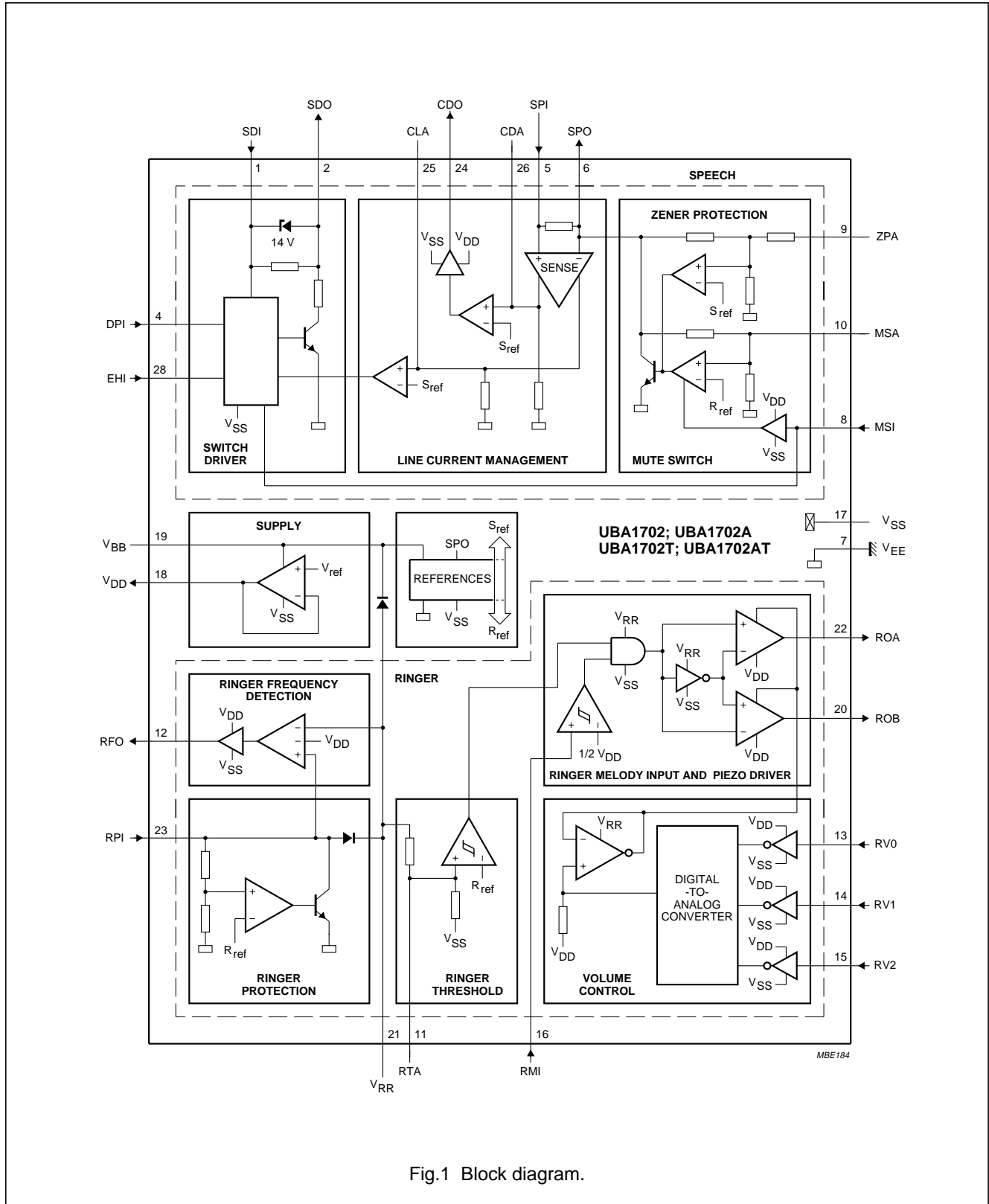

Fig.1 Block diagram.

Line interrupter driver and ringer

UBA1702; UBA1702A

PINNING

SYMBOL	PIN	DESCRIPTION
SDI	1	switch driver input
SDO	2	switch driver output
n.c.	3	not connected
DPI	4	dialling pulse input
SPI	5	speech part input
SPO	6	speech part output
V _{EE}	7	ground for transmission circuit
MSI	8	mute switch input
ZPA	9	Zener protection adjustment input
MSA	10	mute switch adjustment input
RTA	11	ringer threshold adjustment input
RFO	12	ringer frequency output
RV0	13	ringer volume input; bit 0
RV1	14	ringer volume input; bit 1
RV2	15	ringer volume input; bit 2
RMI	16	ringer melody input
V _{SS}	17	ground for microcontroller and ringer
V _{DD}	18	microcontroller supply voltage
V _{BB}	19	supply voltage from transmission circuit
ROB	20	ringer output B
V _{RR}	21	ringer supply voltage
ROA	22	ringer output A
RPI	23	ringer part input
CDO	24	current detection output
CLA	25	current limitation adjustment input
CDA	26	current detection adjustment input
n.c.	27	not connected
EHI	28	electronic hook switch input

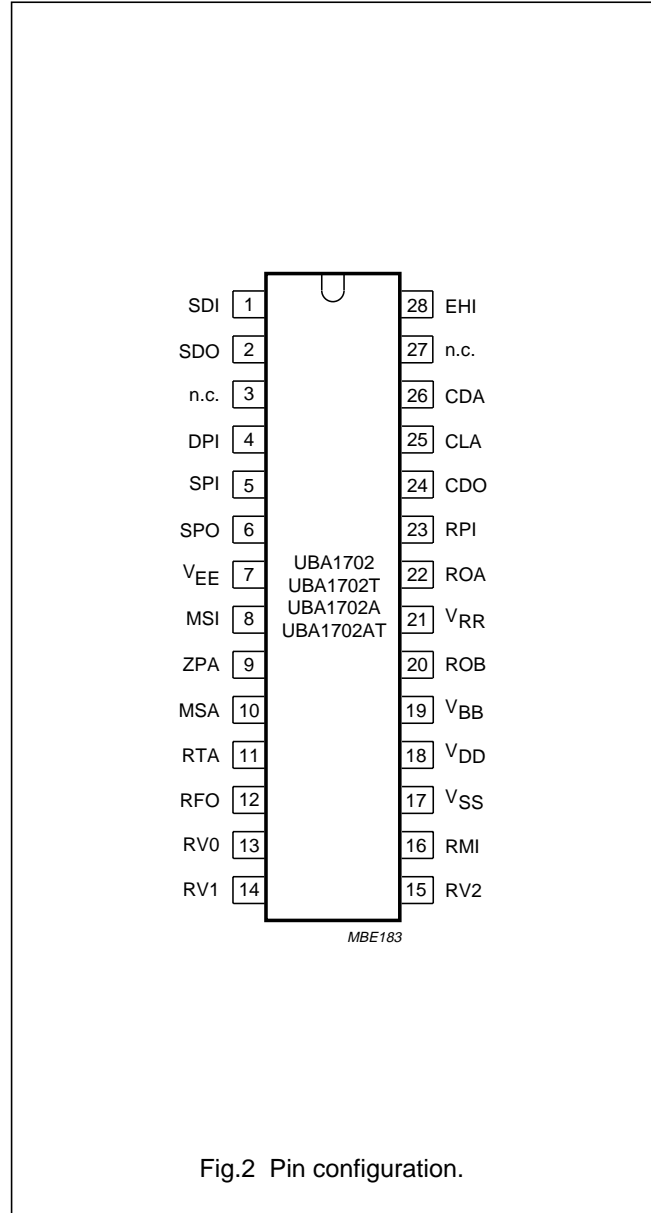

Line interrupter driver and ringer

UBA1702; UBA1702A

FUNCTIONAL DESCRIPTION

The values given in this functional description are typical values except when otherwise specified.

Speech part

The speech part consists of three blocks, the switch driver, the line current management and the mute switch (DMO or NSA) combined with an adjustable over-voltage (zener) protection circuit. The reference block, which generates reference voltages and currents, is also used in the speech part (see Fig.1) by the mute switch block.

SWITCH DRIVER (PINS SDI, SDO, EHI AND DPI)

UBA1702

The UBA1702 switch driver block is intended to generate the appropriate signal to drive an external PMOST interrupter. The source and gate of this PMOST are respectively connected to SDI and SDO. The electronic hook switch input (EHI) and the dialling pulse input (DPI) signals control the state of this PMOST.

The EHI pin is provided with high voltage capability. When the voltage applied at pin EHI is HIGH, the switch driver block will start and generate the proper signals to switch on the external PMOST interrupter.

When the telephone set is equipped with a mechanical hook switch, pin EHI can be connected directly to the switch driver input (pin SDI). For electronic hook switch applications, the EHI pin can be driven by the microcontroller output.

In some special applications, the EHI pin can be current driven. In such a case, the current available at SDO to turn on the PMOST interrupter is approximately 10 times the EHI input current (providing $I_{EHI} < 2 \mu A$).

The EHI pin presents an impedance of 250 kΩ at low input voltage. When the applied voltage at EHI goes above approximately 30 V, the EHI input current remains constant (see Fig.3) so that the EHI impedance increases.

The DPI is designed to switch on or off the external PMOST interrupter (providing EHI is HIGH). When the voltage applied at pin DPI is HIGH, the switch driver block turns off the external PMOST interrupter. When the

voltage applied at pin DPI is LOW, the switch driver block turns on the external PMOST interrupter.

The external PMOST interrupter is controlled by the voltage between the switch driver input and output (pins SDI and SDO).

When the voltage applied at pin EHI is HIGH and the voltage applied at pin DPI is LOW, the voltage at SDO is pulled down to a value less than 0.2 V in order to create a high source-gate voltage (V_{SG}) for the external PMOST. However, in order to avoid break-down of the external PMOST, the voltage difference between SDI and SDO is internally limited to 14 V.

When the voltage applied at pin EHI and the one applied at pin DPI are both HIGH, pin SDO can be considered as being connected to pin SDI via a 1.1 MΩ pull-up resistor while the impedance between SDI and V_{EE} becomes very high (a few MΩ).

When the voltage applied at pin EHI is LOW, whatever the one applied at DPI is, pin SDO can be considered as being connected to pin SDI via a 1.1 MΩ pull-up resistor while the impedance between SDI and V_{EE} becomes almost infinite.

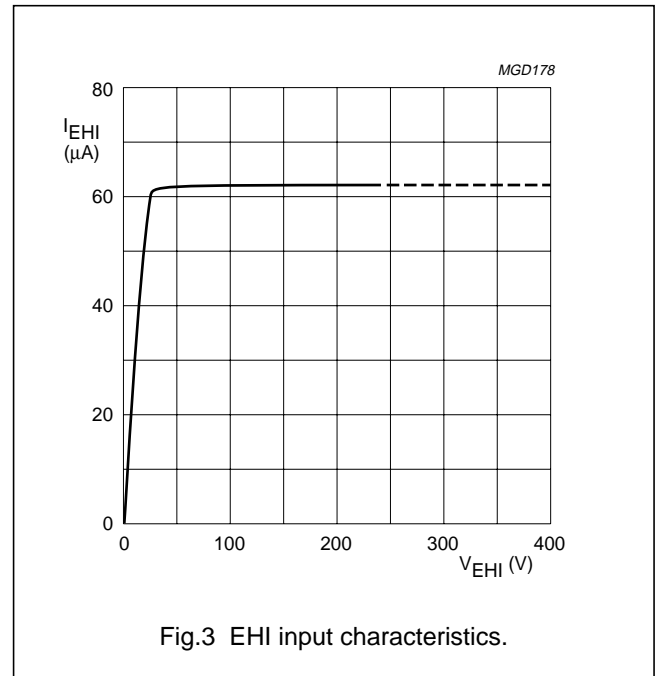

Line interrupter driver and ringer

UBA1702; UBA1702A

UBA1702A

The UBA1702A switch driver block is intended to generate the appropriate signal to drive an external PNP interrupter. The emitter and base of this PNP are respectively connected to SDI and SDO. The EHI and DPI signals control the state of this PNP.

The EHI pin is provided with high voltage capability. When the voltage applied at pin EHI is HIGH, the switch driver block will start and generate the appropriate signals to switch on the external PNP interrupter.

When the telephone set is equipped with a mechanical hook switch, pin EHI can be connected directly to pin SDI. For electronic hook switch applications, the EHI pin can be driven by the microcontroller output.

The EHI pin presents an impedance of 250 k Ω at low input voltage. When the applied voltage at EHI goes above approximately 30 V, the EHI input current remains constant (see Fig.3) so that the EHI impedance increases.

The DPI is designed to switch on or off the external PNP interrupter (providing EHI is HIGH). When the voltage applied at pin DPI is HIGH, the switch driver block turns off the external PNP interrupter. When the voltage applied at pin DPI is LOW, the switch driver block turns on the external PNP interrupter.

The external PNP interrupter is controlled by the current flowing into pin SDO.

When the voltage applied at pin EHI is HIGH and the voltage applied at pin DPI is LOW, pin SDO can be considered as being connected to pin V_{EE} via a 2.2 k Ω resistor in order to create a base current for the external PNP.

When the voltage applied at pin EHI and the one applied at pin DPI are both HIGH, pin SDO can be considered as being connected to pin SDI via a 1.1 M Ω pull-up resistor while the impedance between SDI and V_{EE} becomes very high (a few M Ω).

When the voltage applied at pin EHI is LOW, whatever the one applied at DPI is, pin SDO can be considered as being connected to pin SDI via a 1.1 M Ω pull-up resistor while the impedance between SDI and V_{EE} becomes almost infinite.

LINE CURRENT MANAGEMENT

(PINS SPI, SPO, CDA, CLA AND CDO)

The line current is measured by an internal 2 Ω resistor and a sense circuit connected between the speech part input and output (pins SPI and SPO). The circuit delivers information about the hook switch status at the current detection output (pin CDO) and controls the line current limitation.

When the SPI current exceeds a certain level (3 mA), the sense circuit injects some image of the SPI current into an internal resistor (see Fig.1). The created voltage becomes higher than an internal reference (approximately 0.3 V) and CDO goes HIGH. This current detection level can be increased by connecting a resistor between pins CDA (current detection adjustment) and V_{EE}. It is also possible to connect a capacitor between pins CDA and V_{EE} to filter unwanted AC components of the line current signal. Line current interruption during pulse dialling influences the CDO output.

When the SPI current exceeds another current level (45 mA), the sense circuit injects some image of the SPI current into an internal resistor (see Fig.1). The created voltage becomes higher than an internal reference (approximately 0.4 V) and an internal signal is generated in order to limit the current in the external interrupter thus resulting in a line current limitation. This line current limitation level can be increased up to a maximum value of 120 mA by connecting a resistor between pins CLA (current limitation adjustment) and V_{EE}.

When a PMOST (UBA1702) is used as an interrupter, the SPI current equals the drain or source current of the PMOST and thus also equals the line current.

When a PNP (UBA1702A) is used as an interrupter, the SPI current equals the collector current of the PNP and thus differs from the line current (the PNP base current does not flow into the SPI pin).

Line interrupter driver and ringer

UBA1702; UBA1702A

MUTE SWITCH AND ZENER PROTECTION (PINS MSI, MSA AND ZPA)

The mute switch is, in fact, a switchable and electronic zener diode connected between the speech part output (pin SPO) and V_{EE} .

When the voltage applied at the mute switch input (pin MSI) is LOW, the switch is in over-voltage protection mode and the maximum SPO voltage is limited to 12 V. This level can be increased or decreased by connecting a resistor between pins ZPA (zener protection adjustment) and V_{EE} or ZPA and SPO respectively.

When the voltage applied at pin MSI is HIGH, the switch is in mute mode (DMO or NSA) resulting in a SPO voltage below 3 V. This level can be decreased by connecting a resistor between pins MSA (mute switch adjustment) and SPO. It should be noted that the mute switch stage is supplied from V_{DD} thus a minimum voltage of approximately 2.1 V is required on V_{DD} .

REFERENCE

The bias currents and voltages for the various speech blocks are generated by the reference block which is, in most cases, supplied from pin SPO. This block guarantees a high AC impedance at the SPO pin operating down to a low SPO voltage. Therefore, most speech part blocks operate independently from V_{DD} .

Ringer part

The ringer part consists of five blocks, the ringer protection, the ringer threshold, the ringer frequency detection, the volume control and the piezo driver. The reference block which generates reference voltages and currents is also used in the ringer part (see Fig.1).

RINGER PROTECTION (PINS RPI AND V_{RR})

The ringer protection block converts the ringing current into a limited voltage between the ringer part input (pin RPI) and V_{EE} . This voltage is used (via an internal diode) to generate the ringer supply voltage V_{RR} which is mainly used for all ringer parts. The voltage at pin V_{RR} must be filtered with a 22 μ F capacitor connected between pins V_{RR} and V_{SS} .

In electronic hook switch applications and also in speech mode (see Fig.8), pin RPI is always connected to the telephone line (through a series RC network and a diode bridge). In order not to disturb normal speech operation, a high AC impedance is present at pin RPI (providing the speech level is less than 1.5 V (RMS) i.e. 5.7 dBm).

In the DMO or NSA mode (i.e. MSI is HIGH), the voltage across RPI and V_{EE} is limited to 2.1 V. With this feature and in electronic hook switch applications, several additional ringers can be placed in parallel without tinkling during pulse dialling phase.

RINGER THRESHOLD (PIN RTA)

The piezo driver is internally enabled when the voltage at pin V_{RR} exceeds a threshold level of 11 V. This threshold level can be increased or decreased by connecting a resistor between pins RTA (ringer threshold adjustment) and V_{SS} or RTA and V_{RR} respectively.

Because of the built-in 6.5 V hysteresis, a voltage change at pin V_{RR} (coming from current consumption increase when the piezo output is driven with a melody) will have no influence on this internal enabling signal.

RINGER FREQUENCY DETECTION (PIN RFO)

The ringer frequency detection block generates a square wave signal at the ringer frequency output (pin RFO) with twice the ringer signal frequency. This RFO signal can be used by the microcontroller for frequency discrimination.

When the voltage at pin RPI drops below the voltage at pin V_{DD} , RFO goes LOW. Pin RFO goes HIGH when the voltage at pin RPI exceeds the voltage at pin V_{RR} . This $V_{RR} - V_{DD}$ hysteresis allows the frequency detection circuit to ignore parasitic signals superimposed on the ringing signal.

The voltage at pin EHI must be LOW to get a square wave at pin RFO. When the voltage at pin EHI is LOW, the voltage at pin RFO is always HIGH whatever the one at pin RPI is.

VOLUME CONTROL (PINS RV0, RV1 AND RV2)

The volume control input has three bits RV2, RV1 and RV0 to realize eight volume levels. The volume is controlled by regulating the supply voltage of the piezo output stage. The first six steps have a fixed value of 6 dB, the value of the last step (maximum volume) is dependent on the available voltage at pin V_{RR} .

Default setting during start-up is (RV2 = 0, RV1 = 0, RV0 = 0) which corresponds to minimum volume. In order not to damage the piezo transducer, the differential output ROA – ROB is internally limited to a value less than 32 V (p-p).

Line interrupter driver and ringer

UBA1702; UBA1702A

RINGER MELODY INPUT AND PIEZO DRIVER (PINS RMI, ROA AND ROB)

The input signal at the ringer melody input (pin RMI) may be a square wave or a sine wave which is generated by the microcontroller. The input stage incorporates a small hysteresis (between $0.48V_{DD}$ and $0.52V_{DD}$) and is referenced to $\frac{1}{2}V_{DD}$ which is also the DC level of the signal coming from the microcontroller. Nevertheless, when a sine wave is used, a coupling capacitor of 10 nF (connected between pin RMI and the output of the microcontroller) is required. This 10 nF capacitor value is enough since the RMI input impedance is approximately 250 k Ω .

The piezo driver is an output stage for a piezo transducer which has to be connected between ringer output A and ringer output B (pins ROA and ROB) as a Bridged Tied Load (BTL) or between ROA and V_{SS} as a Single-Ended Load (SEL). The ROA and ROB output signals are square wave and in opposite phase driven by the ringer melody input stage. The minimum output current capability of the ROA and ROB outputs is greater than 80 mA at maximum volume setting ($RV2 = 1$, $RV1 = 1$, $RV0 = 1$) and becomes even greater during output switching. This gives fast rise and fall times resulting in a lot of harmonics.

To obtain maximum efficiency, the piezo driver stage is supplied in series with the V_{DD} supply.

REFERENCE

The bias current for the various ringer blocks is generated by the reference block while this block is supplied from pin V_{RR} or V_{DD} .

Supply part (pins V_{BB} and V_{DD})

The supply block regulates the voltage at pin V_{DD} , referenced to V_{SS} , to a typical value of 3.3 V and can deliver a minimum of 2 mA. This is sufficient to supply most normal microcontrollers. The voltage at pin V_{DD} must be filtered with a 22 μ F capacitor connected between pins V_{DD} and V_{SS} .

In speech mode, this block is supplied from the transmission circuit using pin V_{BB} . The voltage drop between V_{BB} and V_{DD} has been minimized (100 mV at 1 mA, providing $2.5\text{ V} < V_{BB} < 3.0\text{ V}$) in order to allow low voltage operation of the transmission circuit.

In ringer mode, this block is supplied from the ringer part using pin V_{RR} and pin V_{BB} which are tied together through an internal diode (see Fig.1).

When an external (mains or battery) supply is connected to V_{BB} and no speech or ringer signal is applied, V_{DD} (3.3 V) is still present.

During on-hook phase, and when a small current is derived from the line to the microcontroller supply, the circuit stays in a kind of stand-by mode to provide sufficient voltage at pin V_{DD} . This is done to ensure memory retention in the microcontroller.

Line interrupter driver and ringer

UBA1702; UBA1702A

LIMITING VALUES

In accordance with the Absolute Maximum Rating System (IEC 134).

SYMBOL	PARAMETER	CONDITIONS	MIN.	MAX.	UNIT
V_{SDI}, V_{SDO}	maximum input/output switch driver voltage (pins SDI or SDO)	DC; note 1	–	240	V
		pulsed; note 2	–	400	V
V_{EHI}	maximum hook switch input voltage (pin EHI)	DC; note 1	–	240	V
		pulsed; note 2	–	400	V
$V_{i(max)}$	maximum voltage at all logic inputs (pins DPI, MSI, RV0, RV1, RV2 and RMI)		$V_{SS} - 0.4$	$V_{DD} + 0.4$	V
$V_{n(max)}$	maximum voltage at all other pins		–	24	V
$I_{SPI(max)}$	maximum speech part input current (pin SPI)		–	150	mA
$I_{RPI(max)}$	maximum ringer part input current (pin RPI)		–	70	mA
P_{tot}	total power dissipation UBA1702 UBA1702T	$T_{amb} = 75\text{ °C}$	–	1	W
			–	0.625	W
T_{stg}	IC storage temperature		–40	+150	°C
T_{amb}	operating ambient temperature		–25	+75	°C

Notes

1. Continuous.
2. 2 kV surge:
 - a) according to IEC 805-1 part 5. Test generator 10 μ s/700 μ s according to CCITT ($R_{m1} = 15\ \Omega$ and $R_{m2} = 25\ \Omega$).
 - b) pulse sequence > 60 s.
 - c) number of surges: 10.
 - d) polarity change after 5 surges.
 - e) test circuit in combination with 150 V Voltage Dependent Resistor (VDR) and a 3.9 Ω resistor connected in series with the source of the PMOST interrupter (UBA1702).

THERMAL CHARACTERISTICS

SYMBOL	PARAMETER	VALUE	UNIT
$R_{th\ j-a}$	thermal resistance from junction to ambient in free air		
	UBA1702, UBA1702A	45	K/W
	UBA1702T, UBA1702AT	70	K/W

Line interrupter driver and ringer

UBA1702; UBA1702A

CHARACTERISTICS

Speech part: $I_{line} = 20$ mA; DPI = LOW; $T_{amb} = 25$ °C; $V_{EE} = 0$ V; unless otherwise specified.

Ringer part: $V_{line(rms)} = 45$ V; $f = 25$ Hz; using an RC combination of 2.2 k Ω and 820 nF and a diode bridge between the line and the RPI input.

SYMBOL	PARAMETER	CONDITIONS	MIN.	TYP.	MAX.	UNIT
Speech Part						
SWITCH DRIVER AND REFERENCES (PINS SDI, SDO, EHI AND DPI); UBA1702 ONLY						
I_{EE}	V_{EE} current consumption	$V_{SPO} = 4.2$ V	–	–330	–	μ A
V_{SDO}	switch driver output voltage	$V_{SDI} < 12$ V	–	–	0.2	V
SWITCH DRIVER AND REFERENCES (PINS SDI, SDO, EHI AND DPI); UBA1702A ONLY						
I_{EE}	V_{EE} current consumption; excluding PNP interrupter base current	$V_{SDO} = 4.2$ V	–	–510	–	μ A
R_{SDO}	resistance between pins SDO and V_{EE}		–	2.2	–	k Ω
$I_{SDO(max)}$	maximum input current (pin SDO)		7.0	–	–	mA
SWITCH DRIVER AND REFERENCES (PINS SDI, SDO, EHI AND DPI); UBA1702 AND UBA1702A						
I_{SS}	V_{SS} current consumption	$V_{SPO} = 4.2$ V; note 1	–	–280	–	μ A
$V_{SDI-SDO}$	internal voltage limitation between pins SDI and SDO		–	14	–	V
$R_{SDI-SDO}$	resistance between pins SDI and SDO	$V_{SDI} - V_{SDO} < 12$ V	–	1.1	–	M Ω
R_{SDI}	resistance between pins SDI and V_{EE}	$V_{SDI} = V_{EHI} = 48$ V; DPI = HIGH	–	4	–	M Ω
		$V_{SDI} = V_{EHI} = 240$ V; DPI = HIGH	5	20	–	M Ω
R_{EHI}	resistance between pins EHI and V_{EE}	$V_{EHI} = 4.2$ V	170	420	–	k Ω
		$V_{EHI} = 48$ V	–	740	–	k Ω
		$V_{EHI} = 240$ V	–	3.5	–	M Ω
$ Z_{SPO} $	impedance between pins SPO and V_{EE}	$f = 0.3$ to 3.4 kHz	20	–	–	k Ω
$ Z_{VSS} $	impedance between pins V_{SS} and V_{EE}	$f = 0.3$ to 3.4 kHz	10	–	–	k Ω
V_{IH}	HIGH-level input voltage (pin EHI)		$V_{SS} + 1.5$	–	240	V
V_{IL}	LOW-level input voltage (pin EHI)		V_{SS}	–	$V_{SS} + 0.3$	V
I_{IH}	HIGH-level input current (pin EHI)	$V_{EHI} = 4.2$ V	0	10	20	μ A
I_{IL}	LOW-level input current (pin EHI)	$V_{EHI} = \text{LOW}$	–	0	–	μ A
V_{IH}	HIGH-level input voltage (pin DPI)		$V_{SS} + 1.5$	–	V_{DD}	V
V_{IL}	LOW-level input voltage (pin DPI)		V_{SS}	–	$V_{SS} + 0.3$	V
I_{IH}	HIGH-level input current (pin DPI)	$V_{DPI} = \text{HIGH}$	0	–	10	μ A
I_{IL}	LOW-level input current (pin DPI)	$V_{DPI} = \text{LOW}$	–	0	–	μ A

Line interrupter driver and ringer

UBA1702; UBA1702A

SYMBOL	PARAMETER	CONDITIONS	MIN.	TYP.	MAX.	UNIT
MUTE SWITCH AND ZENER PROTECTION (PINS MSI, MSA AND ZPA)						
$V_{SPO(M)}$	adjustable mute voltage referenced to V_{EE}	MSI = HIGH; MSA open-circuit	–	2.7	3	V
		MSI = HIGH; MSA shorted to SPO	–	1.7	–	V
$V_{SPO(Z)}$	adjustable zener voltage referenced to V_{EE}	MSI = LOW; ZPA open-circuit	11.0	12.0	13.0	V
		MSI = LOW; ZPA shorted to SPO	8.3	9.0	9.7	V
		MSI = LOW; ZPA shorted to V_{EE}	16.4	18.0	19.6	V
I_{SPI}	current capability (pin SPI)		150	–	–	mA
V_{IH}	HIGH-level input voltage (pin MSI)		$0.7V_{DD}$	–	V_{DD}	V
V_{IL}	LOW-level input voltage (pin MSI)		V_{SS}	–	$V_{SS} + 0.3$	V
I_{IH}	HIGH-level input current (pin MSI)	$V_{MSI} = \text{HIGH}$	0	–	10	μA
I_{IL}	LOW-level input current (pin MSI)	$V_{MSI} = \text{LOW}$	–	0	–	μA
CURRENT MANAGEMENT (PINS SPI, SPO, CDA, CLA AND CDO)						
$I_{SPI(\text{lim})}$	current limitation (pin SPI)	CLA open-circuit	–	45	–	mA
		CLA shorted to V_{EE}	–	120	–	mA
$I_{SPI(\text{det})}$	current detection (pin SPI)	CDA open-circuit	2	3	4	mA
$R_{SPI-SPO}$	series resistance between pins SPI and SPO		–	2	–	Ω
I_{OH}	HIGH level output current (pin CDO)	$V_{CDO} = V_{DD} - 0.5 \text{ V}$	–	–	–100	μA
I_{OL}	LOW level output current (pin CDO)	$V_{CDO} = V_{SS} + 0.5 \text{ V}$	100	–	–	μA
MICROCONTROLLER SUPPLY (PINS V_{DD} AND V_{BB})						
V_{DD}	supply output voltage referenced to V_{SS}	$V_{BB} > 3.7 \text{ V};$ $I_{DD} = -1 \text{ mA}$	3.0	3.3	3.6	V
$\Delta V_{DD}/\Delta T$	supply output voltage temperature gradient		–	–0.2	–	mV/K
I_{DD}	supply output current capability	$V_{BB} > 3.7 \text{ V}$	–	–	–2	mA
$V_{BB}-V_{DD}$	voltage drop between V_{BB} and V_{DD}	$I_{DD} = -1 \text{ mA};$ $2.5 \text{ V} < V_{BB} < 3.0 \text{ V}$	–	100	–	mV
V_{DDM}	voltage at pin V_{DD} when neither speech nor ringer signal is applied	$I_{DD} = 9 \mu\text{A}$	–	1.4	–	V

Line interrupter driver and ringer

UBA1702; UBA1702A

SYMBOL	PARAMETER	CONDITIONS	MIN.	TYP.	MAX.	UNIT
Ringer part						
PROTECTION (PIN RPI)						
I_{SS}	current consumption	RV2 = 0; RV1 = 0; RV0 = 0	–	–850	–	μA
$I_{RPI(max)}$	maximum input current		70	–	–	mA
V_{RPI}	voltage limit referenced to V_{EE}		–	21	–	V
$V_{RPI d}$	voltage limit in DMO or NSA mode referenced to V_{EE}	$I_{RPI} = 30 \text{ mA}$; MSI = HIGH	–	2.1	–	V
$ Z_{RPI} $	AC input impedance referenced to V_{EE}	$f = 0.3 \text{ to } 3.4 \text{ kHz}$; $V_{RPI} < 1.5 \text{ V (RMS)}$	100	220	–	$\text{k}\Omega$
RINGER THRESHOLD AND FREQUENCY DETECTION (PINS V_{RR} , RTA AND RFO)						
V_{RRth}	ringer supply threshold voltage referenced to V_{SS}	RTA open-circuit;	–	11	–	V
V_{RRhys}	ringer threshold hysteresis voltage		–	6.5	–	V
V_{RPIhys}	ringer frequency detection hysteresis voltage referenced to V_{EE}	RFO = HIGH	–	V_{RR}	–	V
		RFO = LOW	–	V_{DD}	–	V
I_{OH}	HIGH-level output current (pin RFO)	$V_{RFO} = V_{DD} - 0.5 \text{ V}$	–	–	–100	μA
I_{OL}	LOW-level output current (pin RFO)	$V_{RFO} = V_{SS} + 0.5 \text{ V}$	100	–	–	μA
VOLUME CONTROL (PINS RV0, RV1 AND RV2)						
ΔG	gain adjustment range	(RV2, RV1, RV0) from (0, 0, 0) to (1, 1, 0); note 2	–	36	–	dB
ΔG_s	step resolution	(RV2, RV1, RV0) from (0, 0, 0) to (1, 1, 0); note 2	–	6	–	dB
ΔG_{ls}	last step resolution	(RV2, RV1, RV0) from (1, 1, 0) to (1, 1, 1); note 3	–	9.5	12	dB
V_{IH}	HIGH-level input voltage (pins RVx)		$0.7V_{DD}$	–	V_{DD}	V
V_{IL}	LOW-level input voltage (pins RVx)		V_{SS}	–	$0.3V_{DD}$	V
I_{IH}	HIGH-level input current (pins RVx)	$V_{RVx} = \text{HIGH}$	0	–	5	μA
I_{IL}	LOW-level input current (pins RVx)	$V_{RVx} = \text{LOW}$	0	–	5	μA

Line interrupter driver and ringer

UBA1702; UBA1702A

SYMBOL	PARAMETER	CONDITIONS	MIN.	TYP.	MAX.	UNIT
RINGER MELODY INPUT AND PIEZO DRIVER (PINS RMI, ROA AND ROB)						
V_{IH}	HIGH-level input voltage (pin RMI)		$0.52V_{DD}$	–	V_{DD}	V
V_{IL}	LOW-level input voltage (pin RMI)		V_{SS}	–	$0.48V_{DD}$	V
I_{IH}	HIGH-level input current (pin RMI)	$V_{RMI} = \text{HIGH}$	0	–	10	μA
I_{IL}	LOW-level input current (pin RMI)	$V_{RMI} = \text{LOW}$	–10	–	0	μA
$V_{o(\text{min p-p})}$	minimum output voltage between pins ROA and ROB (peak-to-peak value)	$RV2 = 0; RV1 = 0; RV0 = 0$	–	0.15	–	V
$V_{o(\text{p-p})}$	output voltage between pins ROA and ROB (peak-to-peak value)	$RV2 = 1; RV1 = 1; RV0 = 0$	–	9.6	–	V
$V_{o(\text{max p-p})}$	maximum output voltage between pins ROA and ROB (peak-to-peak value)	$RV2 = 1; RV1 = 1; RV0 = 1$	–	28.7	32	V
$ I_{RO} $	ROA or ROB output current capability	sink and source; $RV2 = 1; RV1 = 1; RV0 = 1$	80	–	–	mA
REGULATED MICROCONTROLLER SUPPLY (PIN V_{DD})						
V_{DD}	supply output voltage referenced to V_{SS}	$I_{DD} = -1 \text{ mA}$	3.0	3.35	3.6	V
$\Delta V_{DD}/\Delta T$	supply output voltage temperature gradient		–	0	–	mV/K
I_{DD}	supply output current capability		–	–	–2	mA

Notes

1. I_{SS} has no influence on AGC characteristics of the TEA106x transmission circuit when V_{SS} is connected to the SLPE pin of TEA106x.
2. Independent of V_{RR} if greater than 10 V.
3. Without piezo transducer, dependent on V_{RR} .

Line interrupter driver and ringer

UBA1702; UBA1702A

TEST AND APPLICATION INFORMATION

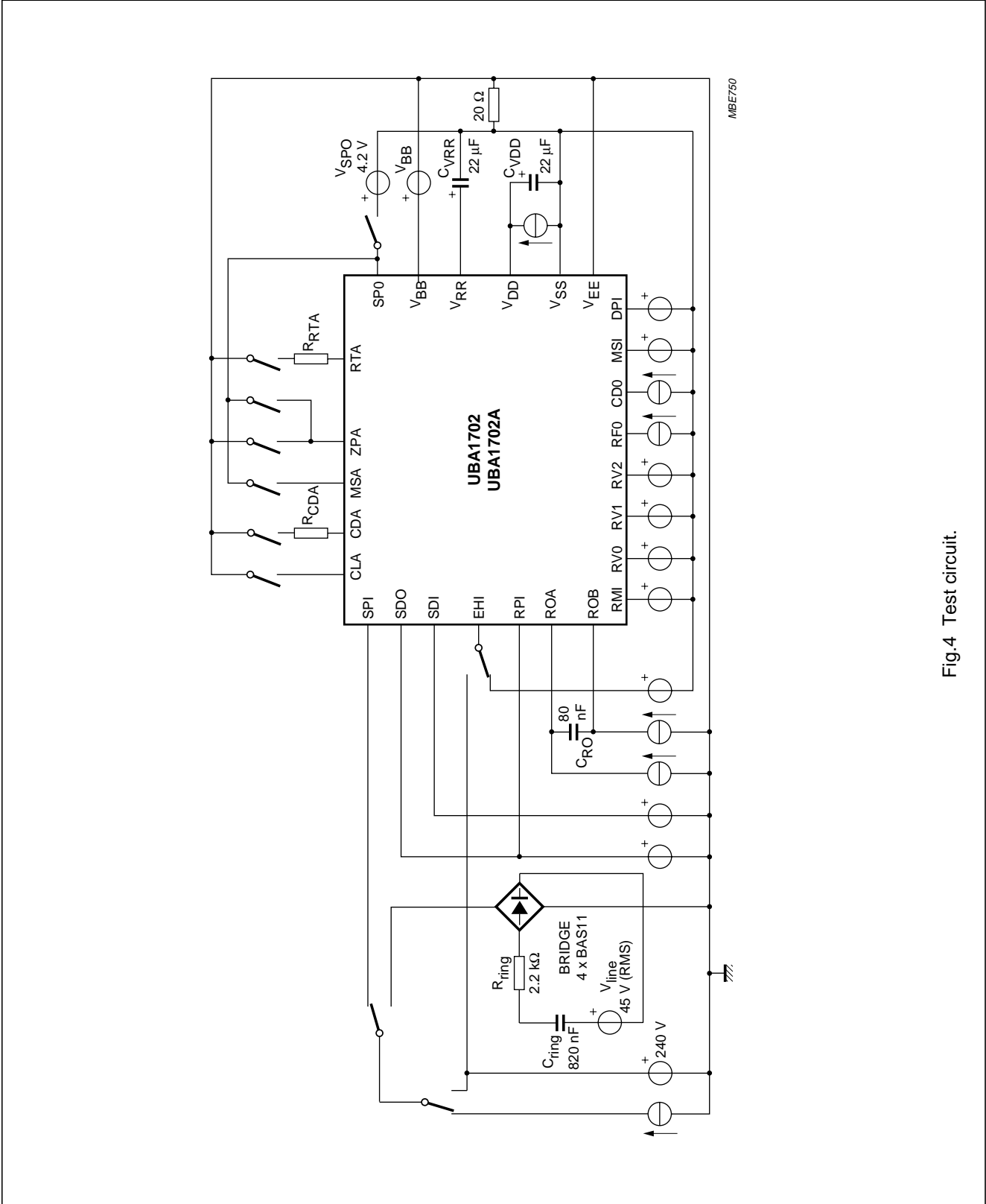

Fig.4 Test circuit.

Line interrupter driver and ringer

UBA1702; UBA1702A

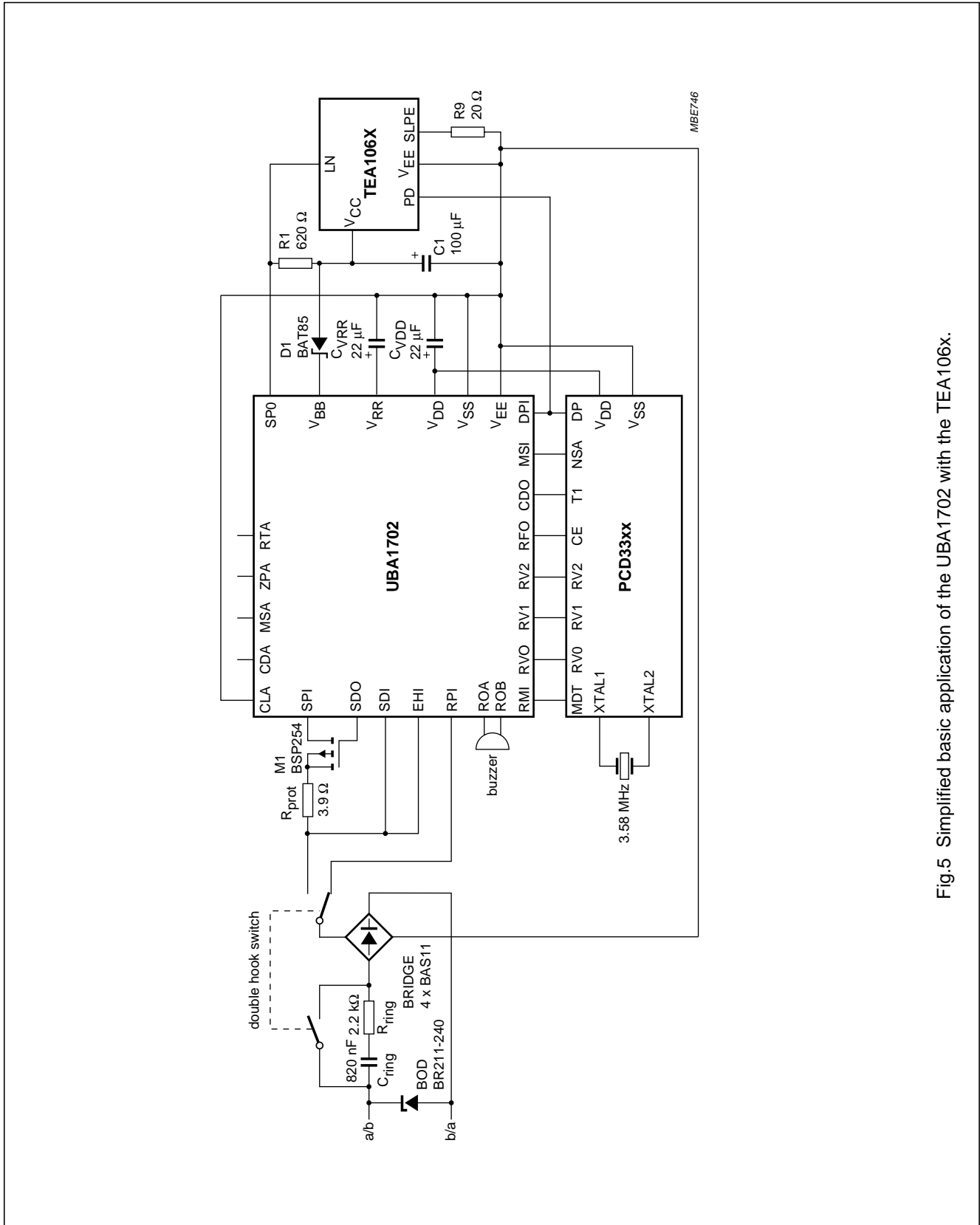

Fig.5 Simplified basic application of the UBA1702 with the TEA106x.

Line interrupter driver and ringer

UBA1702; UBA1702A

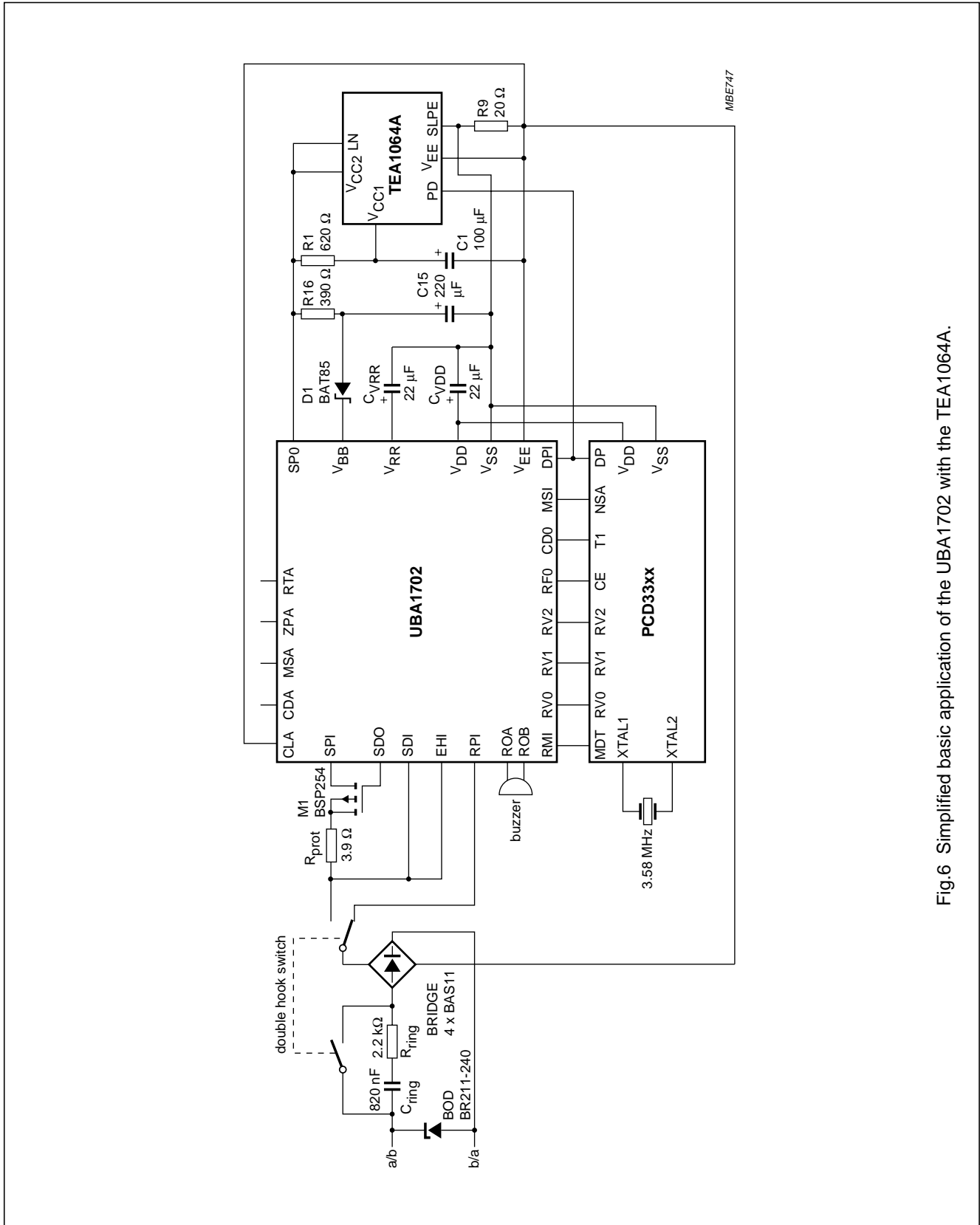

Fig.6 Simplified basic application of the UBA1702 with the TEA1064A.

Line interrupter driver and ringer

UBA1702; UBA1702A

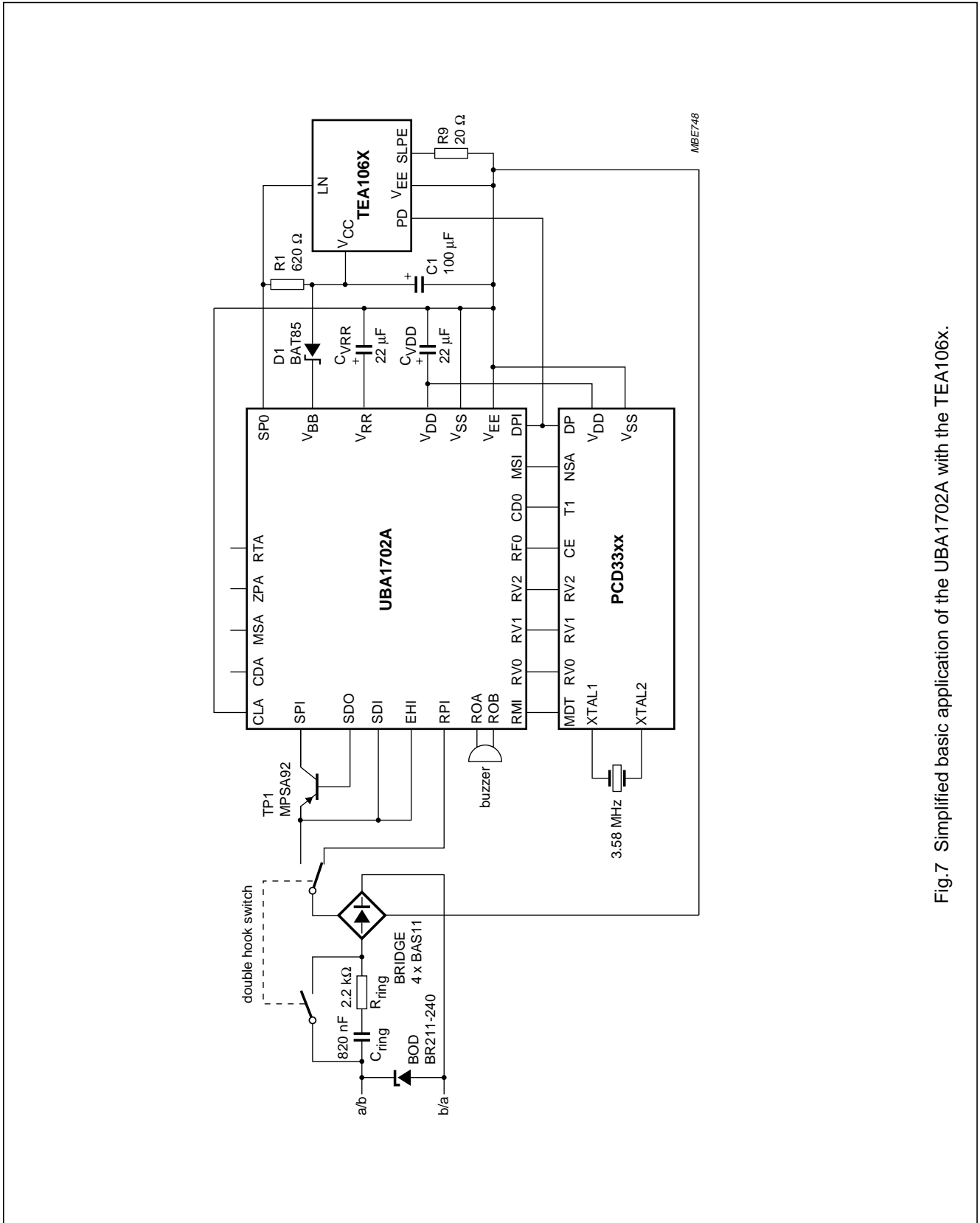

Fig.7 Simplified basic application of the UBA1702A with the TEA106x.

Line interrupter driver and ringer

UBA1702; UBA1702A

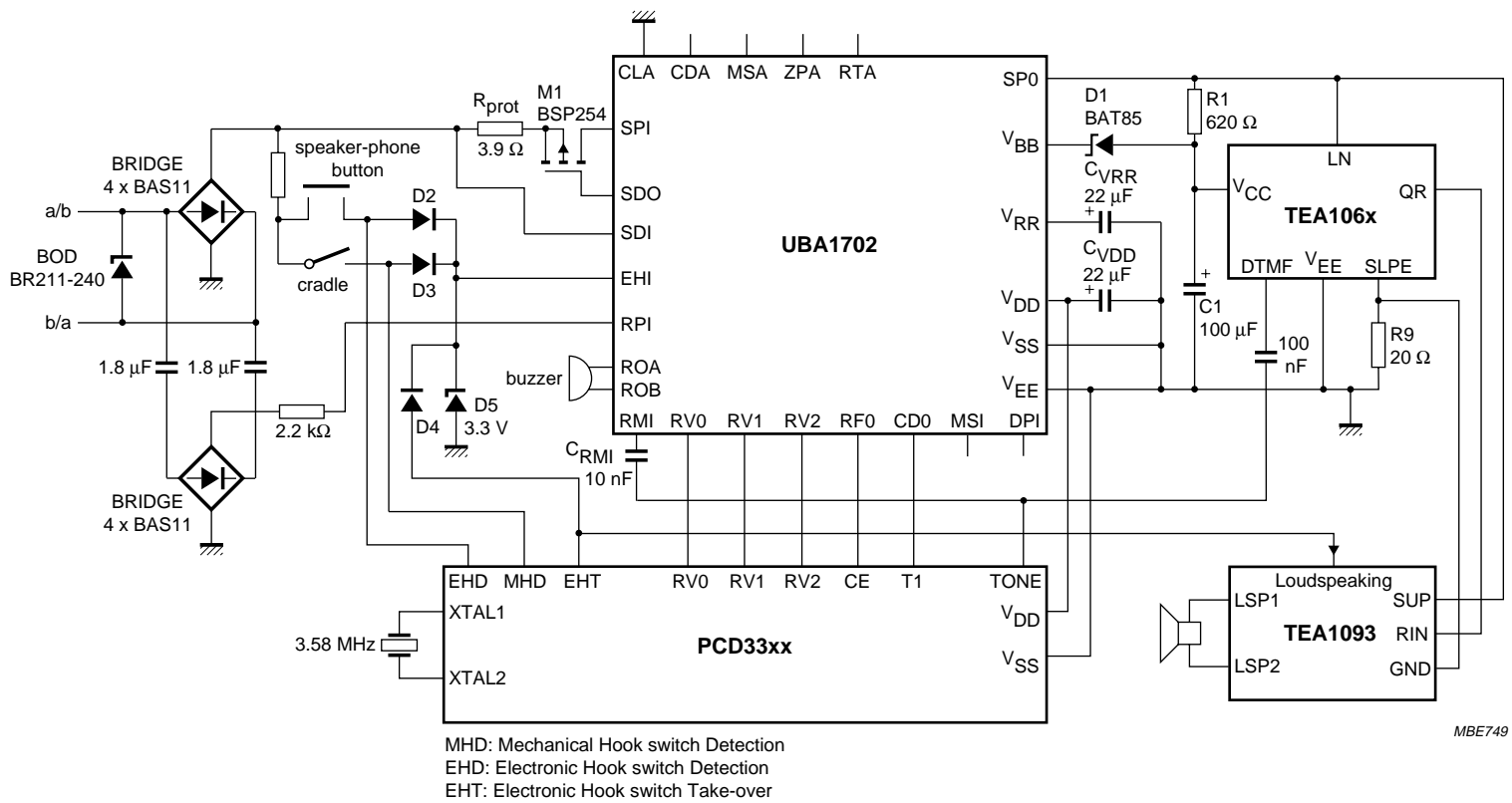

Fig.8 Simplified proposal for electronic hook switch application of the UBA1702 in combination with a transmission and a hands-free circuit.

MBE749

Line interrupter driver and ringer

UBA1702; UBA1702A

PACKAGE OUTLINES

DIP28: plastic dual in-line package; 28 leads (600 mil)

SOT117-1

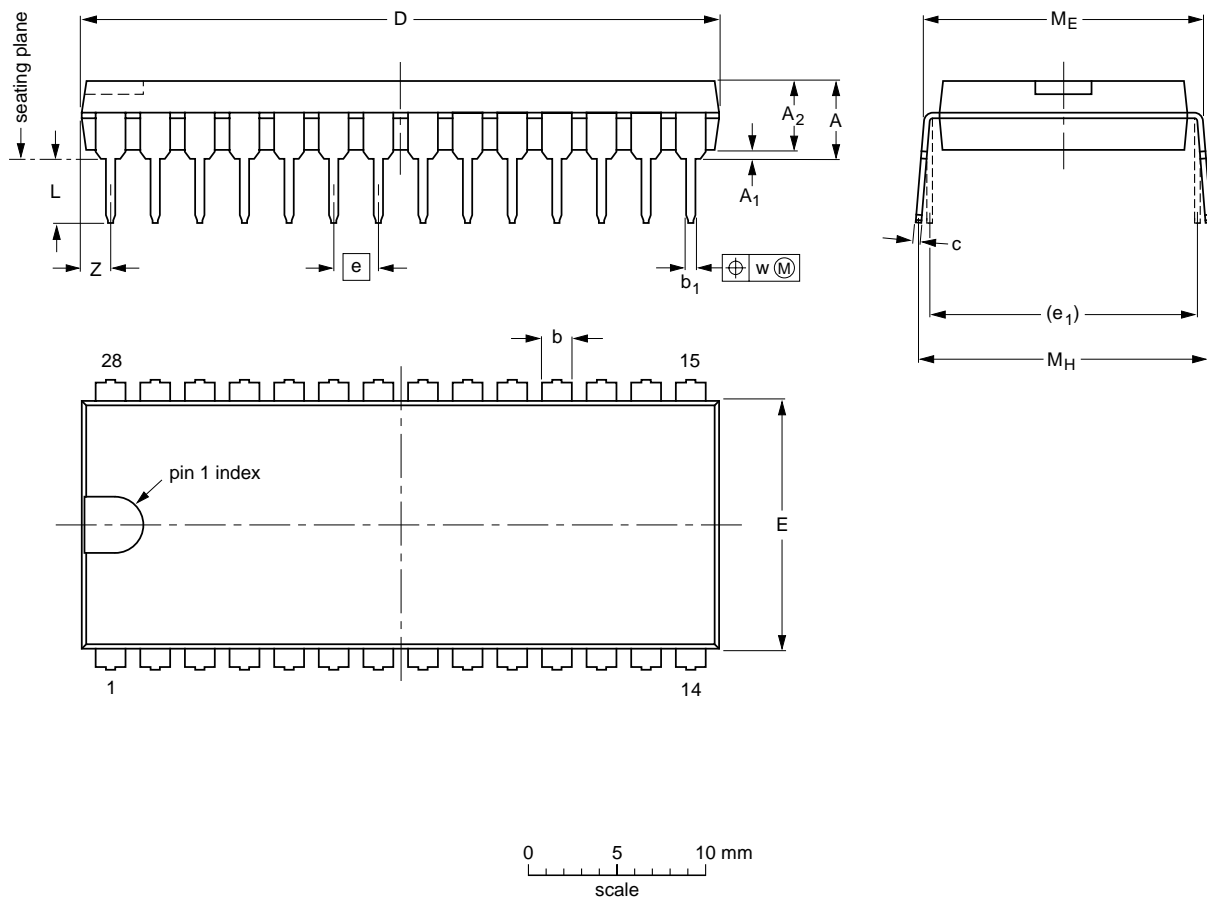

DIMENSIONS (inch dimensions are derived from the original mm dimensions)

UNIT	A max.	A ₁ min.	A ₂ max.	b	b ₁	c	D ⁽¹⁾	E ⁽¹⁾	e	e ₁	L	M _E	M _H	w	Z ⁽¹⁾ max.
mm	5.1	0.51	4.0	1.7 1.3	0.53 0.38	0.32 0.23	36.0 35.0	14.1 13.7	2.54	15.24	3.9 3.4	15.80 15.24	17.15 15.90	0.25	1.7
inches	0.20	0.020	0.16	0.066 0.051	0.020 0.014	0.013 0.009	1.41 1.34	0.56 0.54	0.10	0.60	0.15 0.13	0.62 0.60	0.68 0.63	0.01	0.067

Note

1. Plastic or metal protrusions of 0.25 mm maximum per side are not included.

OUTLINE VERSION	REFERENCES				EUROPEAN PROJECTION	ISSUE DATE
	IEC	JEDEC	EIAJ			
SOT117-1	051G05	MO-015AH				92-11-17 95-01-14

Line interrupter driver and ringer

UBA1702; UBA1702A

SO28: plastic small outline package; 28 leads; body width 7.5 mm

SOT136-1

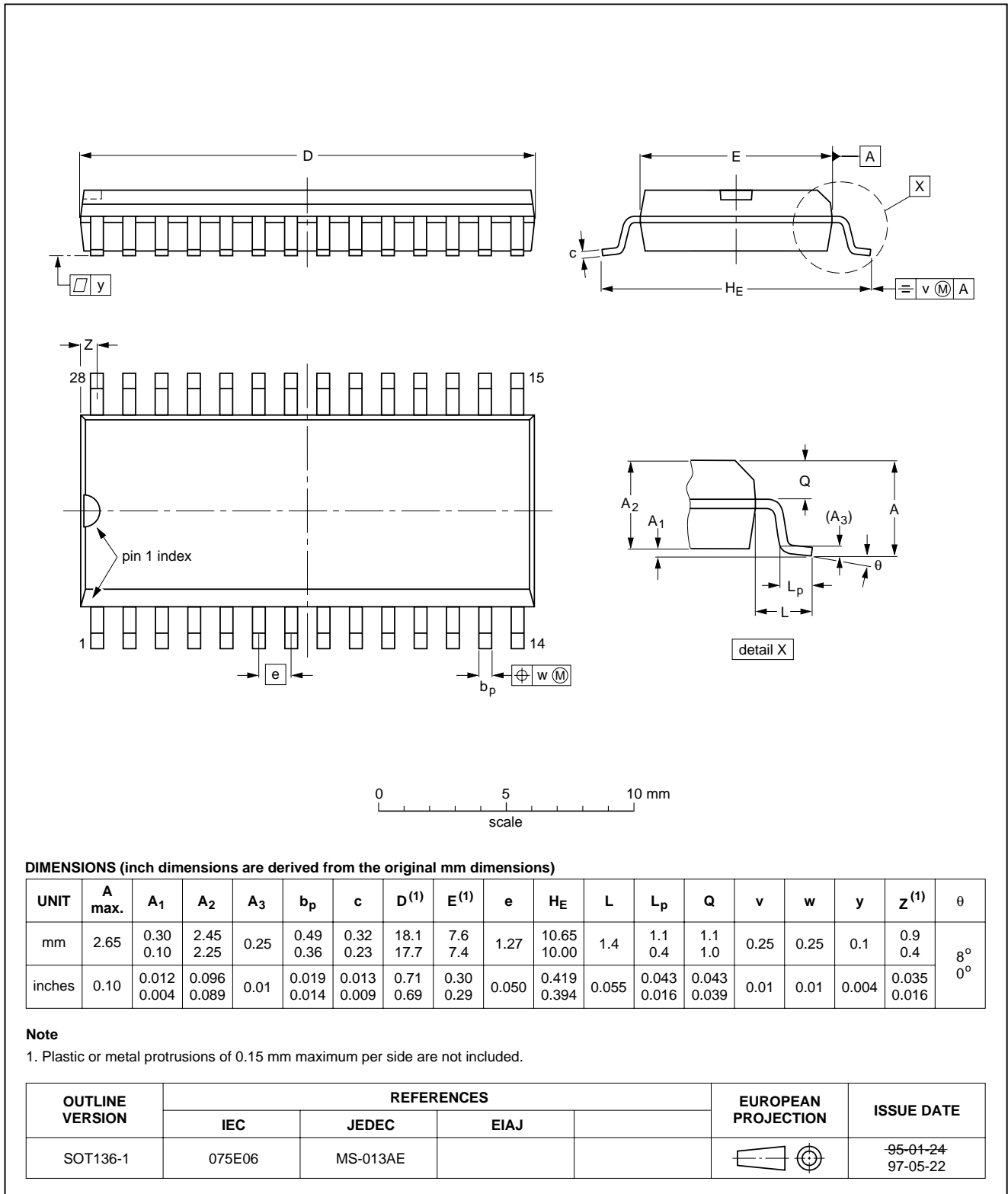

Line interrupter driver and ringer

UBA1702; UBA1702A

SOLDERING

Introduction

There is no soldering method that is ideal for all IC packages. Wave soldering is often preferred when through-hole and surface mounted components are mixed on one printed-circuit board. However, wave soldering is not always suitable for surface mounted ICs, or for printed-circuits with high population densities. In these situations reflow soldering is often used.

This text gives a very brief insight to a complex technology. A more in-depth account of soldering ICs can be found in our *"IC Package Databook"* (order code 9398 652 90011).

DIP

SOLDERING BY DIPPING OR BY WAVE

The maximum permissible temperature of the solder is 260 °C; solder at this temperature must not be in contact with the joint for more than 5 seconds. The total contact time of successive solder waves must not exceed 5 seconds.

The device may be mounted up to the seating plane, but the temperature of the plastic body must not exceed the specified maximum storage temperature ($T_{stg\ max}$). If the printed-circuit board has been pre-heated, forced cooling may be necessary immediately after soldering to keep the temperature within the permissible limit.

REPAIRING SOLDERED JOINTS

Apply a low voltage soldering iron (less than 24 V) to the lead(s) of the package, below the seating plane or not more than 2 mm above it. If the temperature of the soldering iron bit is less than 300 °C it may remain in contact for up to 10 seconds. If the bit temperature is between 300 and 400 °C, contact may be up to 5 seconds.

SO

REFLOW SOLDERING

Reflow soldering techniques are suitable for all SO packages.

Reflow soldering requires solder paste (a suspension of fine solder particles, flux and binding agent) to be applied to the printed-circuit board by screen printing, stencilling or pressure-syringe dispensing before package placement.

Several techniques exist for reflowing; for example, thermal conduction by heated belt. Dwell times vary between 50 and 300 seconds depending on heating method. Typical reflow temperatures range from 215 to 250 °C.

Preheating is necessary to dry the paste and evaporate the binding agent. Preheating duration: 45 minutes at 45 °C.

WAVE SOLDERING

Wave soldering techniques can be used for all SO packages if the following conditions are observed:

- A double-wave (a turbulent wave with high upward pressure followed by a smooth laminar wave) soldering technique should be used.
- The longitudinal axis of the package footprint must be parallel to the solder flow.
- The package footprint must incorporate solder thieves at the downstream end.

During placement and before soldering, the package must be fixed with a droplet of adhesive. The adhesive can be applied by screen printing, pin transfer or syringe dispensing. The package can be soldered after the adhesive is cured.

Maximum permissible solder temperature is 260 °C, and maximum duration of package immersion in solder is 10 seconds, if cooled to less than 150 °C within 6 seconds. Typical dwell time is 4 seconds at 250 °C.

A mildly-activated flux will eliminate the need for removal of corrosive residues in most applications.

REPAIRING SOLDERED JOINTS

Fix the component by first soldering two diagonally-opposite end leads. Use only a low voltage soldering iron (less than 24 V) applied to the flat part of the lead. Contact time must be limited to 10 seconds at up to 300 °C. When using a dedicated tool, all other leads can be soldered in one operation within 2 to 5 seconds between 270 and 320 °C.

Line interrupter driver and ringer

UBA1702; UBA1702A

DEFINITIONS

Data sheet status	
Objective specification	This data sheet contains target or goal specifications for product development.
Preliminary specification	This data sheet contains preliminary data; supplementary data may be published later.
Product specification	This data sheet contains final product specifications.
Limiting values	
Limiting values given are in accordance with the Absolute Maximum Rating System (IEC 134). Stress above one or more of the limiting values may cause permanent damage to the device. These are stress ratings only and operation of the device at these or at any other conditions above those given in the Characteristics sections of the specification is not implied. Exposure to limiting values for extended periods may affect device reliability.	
Application information	
Where application information is given, it is advisory and does not form part of the specification.	

LIFE SUPPORT APPLICATIONS

These products are not designed for use in life support appliances, devices, or systems where malfunction of these products can reasonably be expected to result in personal injury. Philips customers using or selling these products for use in such applications do so at their own risk and agree to fully indemnify Philips for any damages resulting from such improper use or sale

Philips Semiconductors – a worldwide company

Argentina: see South America

Australia: 34 Waterloo Road, NORTH RYDE, NSW 2113,
Tel. +61 2 9805 4455, Fax. +61 2 9805 4466

Austria: Computerstr. 6, A-1101 WIEN, P.O. Box 213, Tel. +43 160 1010,
Fax. +43 160 101 1210

Belarus: Hotel Minsk Business Center, Bld. 3, r. 1211, Volodarski Str. 6,
220050 MINSK, Tel. +375 172 200 733, Fax. +375 172 200 773

Belgium: see The Netherlands

Brazil: see South America

Bulgaria: Philips Bulgaria Ltd., Energoproject, 15th floor,
51 James Bourchier Blvd., 1407 SOFIA,
Tel. +359 2 689 211, Fax. +359 2 689 102

Canada: PHILIPS SEMICONDUCTORS/COMPONENTS,
Tel. +1 800 234 7381

China/Hong Kong: 501 Hong Kong Industrial Technology Centre,
72 Tat Chee Avenue, Kowloon Tong, HONG KONG,
Tel. +852 2319 7888, Fax. +852 2319 7700

Colombia: see South America

Czech Republic: see Austria

Denmark: Prags Boulevard 80, PB 1919, DK-2300 COPENHAGEN S,
Tel. +45 32 88 2636, Fax. +45 31 57 0044

Finland: Sinikalliontie 3, FIN-02630 ESPOO,
Tel. +358 9 615800, Fax. +358 9 61580920

France: 4 Rue du Port-aux-Vins, BP317, 92156 SURESNES Cedex,
Tel. +33 1 40 99 6161, Fax. +33 1 40 99 6427

Germany: Hammerbrookstraße 69, D-20097 HAMBURG,
Tel. +49 40 23 53 60, Fax. +49 40 23 536 300

Greece: No. 15, 25th March Street, GR 17778 TAVROS/ATHENS,
Tel. +30 1 4894 339/239, Fax. +30 1 4814 240

Hungary: see Austria

India: Philips INDIA Ltd, Band Box Building, 2nd floor,
254-D, Dr. Annie Besant Road, Worli, MUMBAI 400 025,
Tel. +91 22 493 8541, Fax. +91 22 493 0966

Indonesia: see Singapore

Ireland: Newstead, Clonskeagh, DUBLIN 14,
Tel. +353 1 7640 000, Fax. +353 1 7640 200

Israel: RAPAC Electronics, 7 Kehilat Saloniki St, PO Box 18053,
TEL AVIV 61180, Tel. +972 3 645 0444, Fax. +972 3 649 1007

Italy: PHILIPS SEMICONDUCTORS, Piazza IV Novembre 3,
20124 MILANO, Tel. +39 2 6752 2531, Fax. +39 2 6752 2557

Japan: Philips Bldg 13-37, Kohnan 2-chome, Minato-ku, TOKYO 108,
Tel. +81 3 3740 5130, Fax. +81 3 3740 5077

Korea: Philips House, 260-199 Itaewon-dong, Yongsan-ku, SEOUL,
Tel. +82 2 709 1412, Fax. +82 2 709 1415

Malaysia: No. 76 Jalan Universiti, 46200 PETALING JAYA, SELANGOR,
Tel. +60 3 750 5214, Fax. +60 3 757 4880

Mexico: 5900 Gateway East, Suite 200, EL PASO, TEXAS 79905,
Tel. +9-5 800 234 7381

Middle East: see Italy

Netherlands: Postbus 90050, 5600 PB EINDHOVEN, Bldg. VB,
Tel. +31 40 27 82785, Fax. +31 40 27 88399

New Zealand: 2 Wagener Place, C.P.O. Box 1041, AUCKLAND,
Tel. +64 9 849 4160, Fax. +64 9 849 7811

Norway: Box 1, Manglerud 0612, OSLO,
Tel. +47 22 74 8000, Fax. +47 22 74 8341

Philippines: Philips Semiconductors Philippines Inc.,
106 Valero St. Salcedo Village, P.O. Box 2108 MCC, MAKATI,
Metro MANILA, Tel. +63 2 816 6380, Fax. +63 2 817 3474

Poland: Ul. Lukiska 10, PL 04-123 WARSZAWA,
Tel. +48 22 612 2831, Fax. +48 22 612 2327

Portugal: see Spain

Romania: see Italy

Russia: Philips Russia, Ul. Usatcheva 35A, 119048 MOSCOW,
Tel. +7 095 755 6918, Fax. +7 095 755 6919

Singapore: Lorong 1, Toa Payoh, SINGAPORE 1231,
Tel. +65 350 2538, Fax. +65 251 6500

Slovakia: see Austria

Slovenia: see Italy

South Africa: S.A. PHILIPS Pty Ltd., 195-215 Main Road Martindale,
2092 JOHANNESBURG, P.O. Box 7430 Johannesburg 2000,
Tel. +27 11 470 5911, Fax. +27 11 470 5494

South America: Rua do Rocio 220, 5th floor, Suite 51,
04552-903 São Paulo, SÃO PAULO - SP, Brazil,
Tel. +55 11 821 2333, Fax. +55 11 829 1849

Spain: Balmes 22, 08007 BARCELONA,
Tel. +34 3 301 6312, Fax. +34 3 301 4107

Sweden: Kottbygatan 7, Akalla, S-16485 STOCKHOLM,
Tel. +46 8 632 2000, Fax. +46 8 632 2745

Switzerland: Allmendstrasse 140, CH-8027 ZÜRICH,
Tel. +41 1 488 2686, Fax. +41 1 481 7730

Taiwan: Philips Semiconductors, 6F, No. 96, Chien Kuo N. Rd., Sec. 1,
TAIPEI, Taiwan Tel. +886 2 2134 2865, Fax. +886 2 2134 2874

Thailand: PHILIPS ELECTRONICS (THAILAND) Ltd.,
209/2 Sanpavuth-Bangna Road Prakanong, BANGKOK 10260,
Tel. +66 2 745 4090, Fax. +66 2 398 0793

Turkey: Talatpasa Cad. No. 5, 80640 GÜLTEPE/ISTANBUL,
Tel. +90 212 279 2770, Fax. +90 212 282 6707

Ukraine: PHILIPS UKRAINE, 4 Patrice Lumumba str., Building B, Floor 7,
252042 KIEV, Tel. +380 44 264 2776, Fax. +380 44 268 0461

United Kingdom: Philips Semiconductors Ltd., 276 Bath Road, Hayes,
MIDDLESEX UB3 5BX, Tel. +44 181 730 5000, Fax. +44 181 754 8421

United States: 811 East Arques Avenue, SUNNYVALE, CA 94088-3409,
Tel. +1 800 234 7381

Uruguay: see South America

Vietnam: see Singapore

Yugoslavia: PHILIPS, Trg N. Pasica 5/v, 11000 BEOGRAD,
Tel. +381 11 625 344, Fax. +381 11 635 777

For all other countries apply to: Philips Semiconductors, Marketing & Sales Communications,
Building BE-p, P.O. Box 218, 5600 MD EINDHOVEN, The Netherlands, Fax. +31 40 27 24825

Internet: <http://www.semiconductors.philips.com>

© Philips Electronics N.V. 1997

SCA55

All rights are reserved. Reproduction in whole or in part is prohibited without the prior written consent of the copyright owner.

The information presented in this document does not form part of any quotation or contract, is believed to be accurate and reliable and may be changed without notice. No liability will be accepted by the publisher for any consequence of its use. Publication thereof does not convey nor imply any license under patent- or other industrial or intellectual property rights.

Printed in The Netherlands

417027/1200/03/pp24

Date of release: 1997 Sep 29

Document order number: 9397 750 02514

Let's make things better.

Philips
Semiconductors



PHILIPS