

# DATA SHEET



## **BAW56W** High-speed double diode

Product specification  
Supersedes data of 1996 Sep 17

1999 May 11

# High-speed double diode

# BAW56W

## FEATURES

- Very small plastic SMD package
- High switching speed: max. 4 ns
- Continuous reverse voltage: max. 75 V
- Repetitive peak reverse voltage: max. 85 V
- Repetitive peak forward current: max. 500 mA.

## APPLICATIONS

- High-speed switching in e.g. surface mounted circuits.

## DESCRIPTION

The BAW56W consists of two high-speed switching diodes with common anodes, fabricated in planar technology, and encapsulated in the very small SOT323 plastic SMD package.

## PINNING

PIN	DESCRIPTION
1	cathode (k1)
2	cathode (k2)
3	common anode

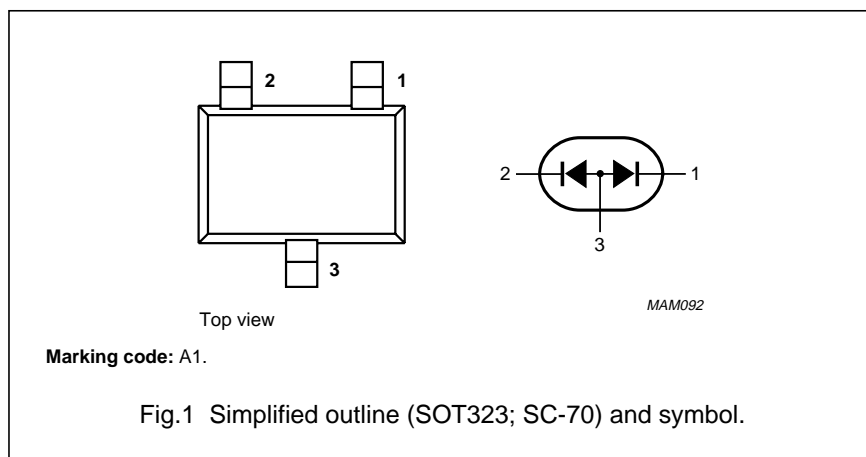

## LIMITING VALUES

In accordance with the Absolute Maximum Rating System (IEC 134).

SYMBOL	PARAMETER	CONDITIONS	MIN.	MAX.	UNIT
<b>Per diode</b>					
$V_{RRM}$	repetitive peak reverse voltage		–	85	V
$V_R$	continuous reverse voltage		–	75	V
$I_F$	continuous forward current	single diode loaded; note 1; see Fig.2	–	150	mA
		double diode loaded; note 1; see Fig.2	–	130	mA
$I_{FRM}$	repetitive peak forward current		–	500	mA
$I_{FSM}$	non-repetitive peak forward current	square wave; $T_j = 25\text{ °C}$ prior to surge; see Fig.4			
		$t = 1\ \mu\text{s}$	–	4	A
		$t = 1\ \text{ms}$	–	1	A
		$t = 1\ \text{s}$	–	0.5	A
$P_{tot}$	total power dissipation	$T_{amb} = 25\text{ °C}$ ; note 1	–	200	mW
$T_{stg}$	storage temperature		–65	+150	°C
$T_j$	junction temperature		–	150	°C

## Note

1. Device mounted on an FR4 printed-circuit board.

## High-speed double diode

BAW56W

**ELECTRICAL CHARACTERISTICS** $T_j = 25\text{ }^\circ\text{C}$  unless otherwise specified.

SYMBOL	PARAMETER	CONDITIONS	MAX.	UNIT
<b>Per diode</b>				
$V_F$	forward voltage	see Fig.3 $I_F = 1\text{ mA}$ $I_F = 10\text{ mA}$ $I_F = 50\text{ mA}$ $I_F = 150\text{ mA}$	715 855 1 1.25	mV mV V V
$I_R$	reverse current	see Fig.5 $V_R = 25\text{ V}$ $V_R = 75\text{ V}$ $V_R = 25\text{ V}; T_j = 150\text{ }^\circ\text{C}$ $V_R = 75\text{ V}; T_j = 150\text{ }^\circ\text{C}$	30 1 30 50	nA $\mu\text{A}$ $\mu\text{A}$ $\mu\text{A}$
$C_d$	diode capacitance	$f = 1\text{ MHz}; V_R = 0$ ; see Fig.6	2	pF
$t_{rr}$	reverse recovery time	when switched from $I_F = 10\text{ mA}$ to $I_R = 10\text{ mA}; R_L = 100\ \Omega$ ; measured at $I_R = 1\text{ mA}$ ; see Fig.7	4	ns
$V_{fr}$	forward recovery voltage	when switched from $I_F = 10\text{ mA}$ ; $t_r = 20\text{ ns}$ ; see Fig.8	1.75	V

**THERMAL CHARACTERISTICS**

SYMBOL	PARAMETER	CONDITIONS	VALUE	UNIT
$R_{th\ j-tp}$	thermal resistance from junction to tie-point		300	K/W
$R_{th\ j-a}$	thermal resistance from junction to ambient	note 1	625	K/W

**Note**

1. Device mounted on an FR4 printed-circuit board.

High-speed double diode

BAW56W

GRAPHICAL DATA

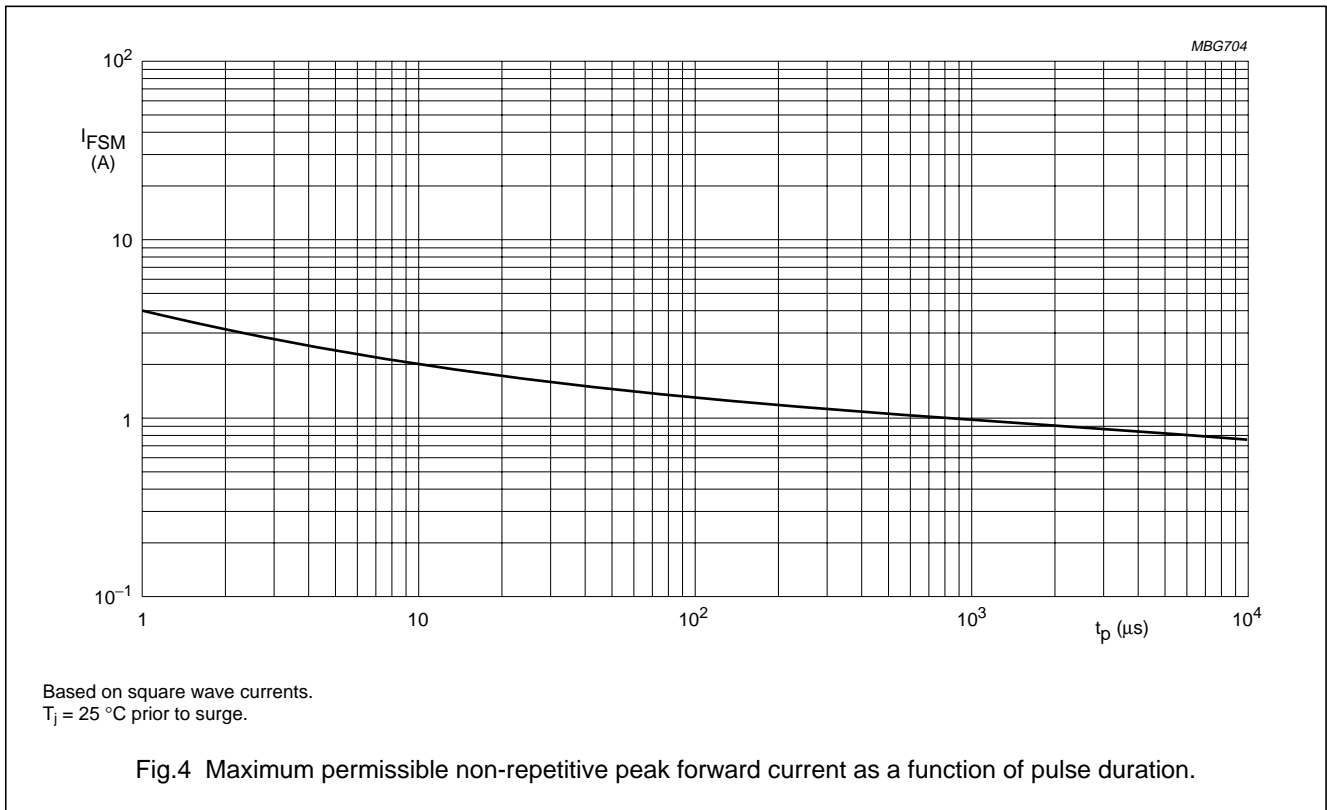
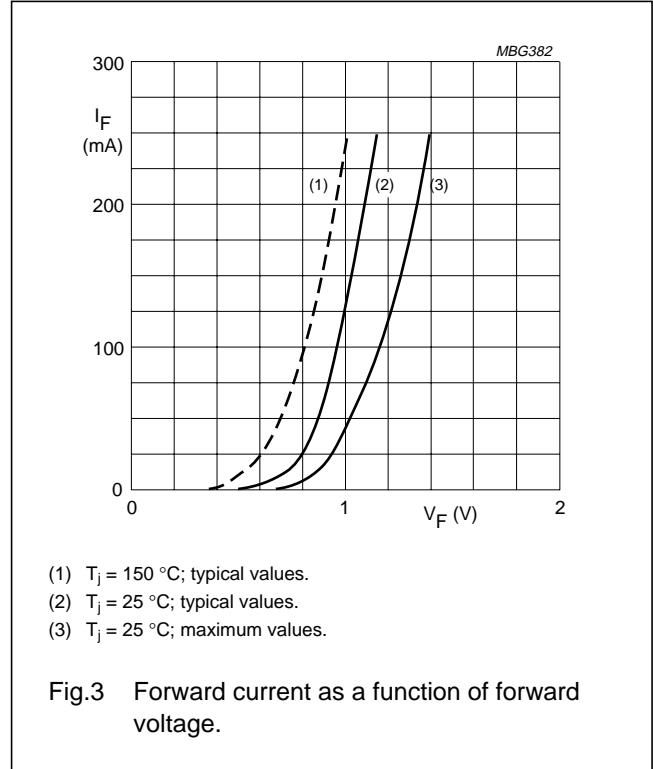
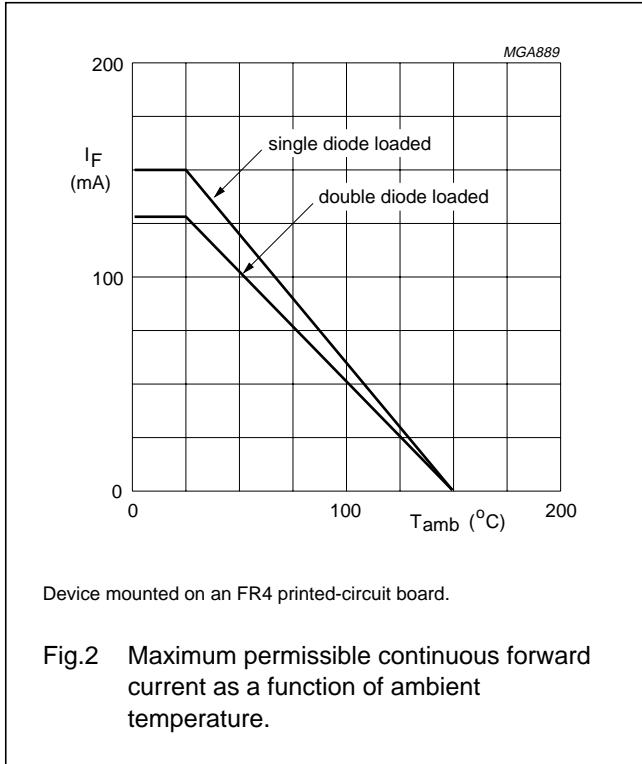

High-speed double diode

BAW56W

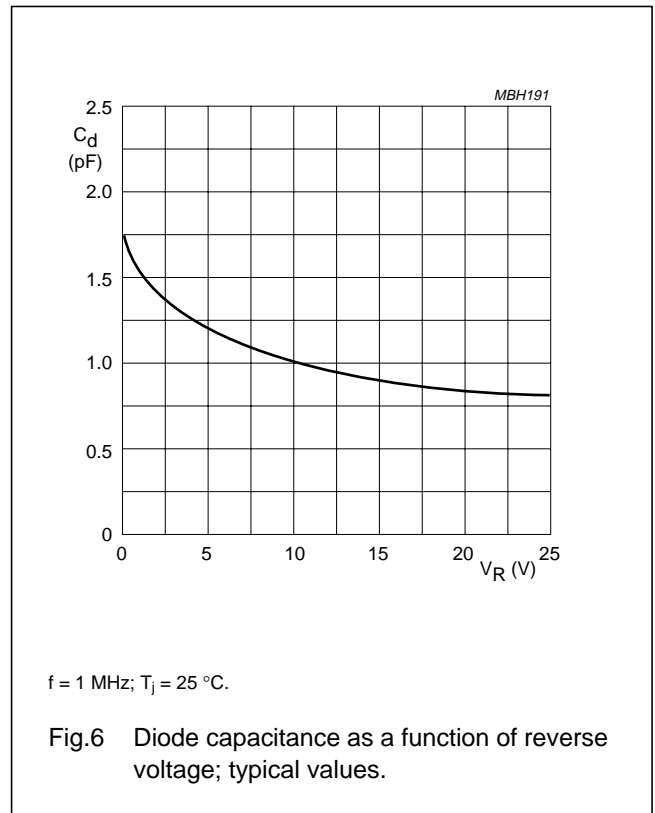
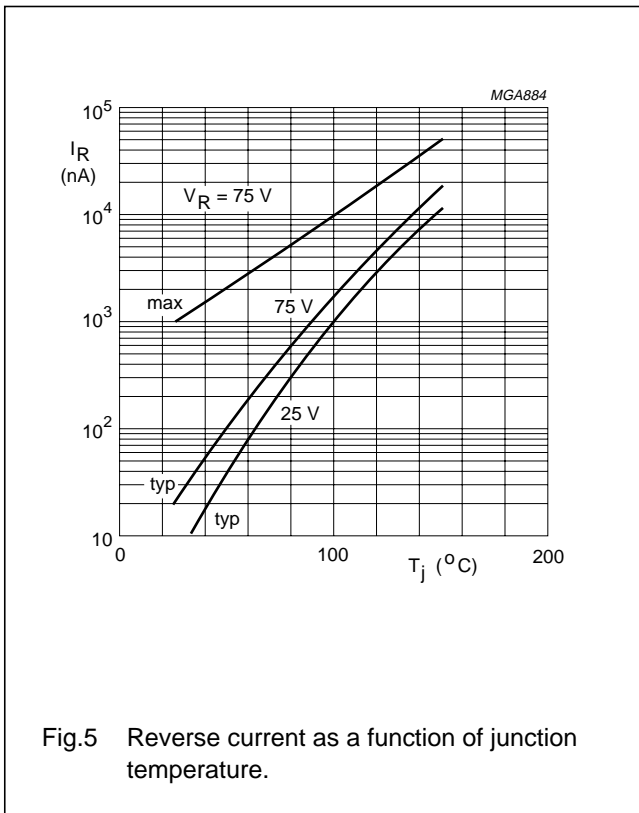

High-speed double diode

BAW56W

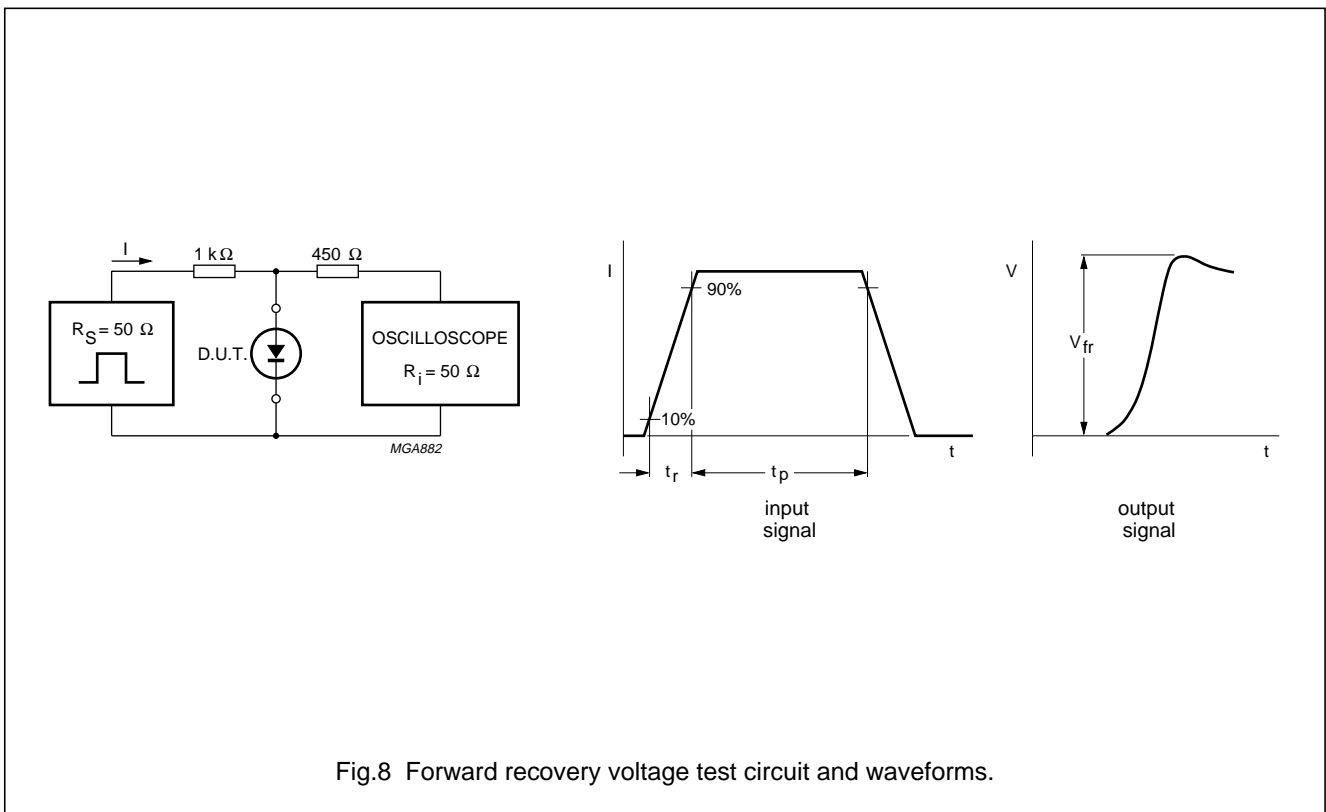
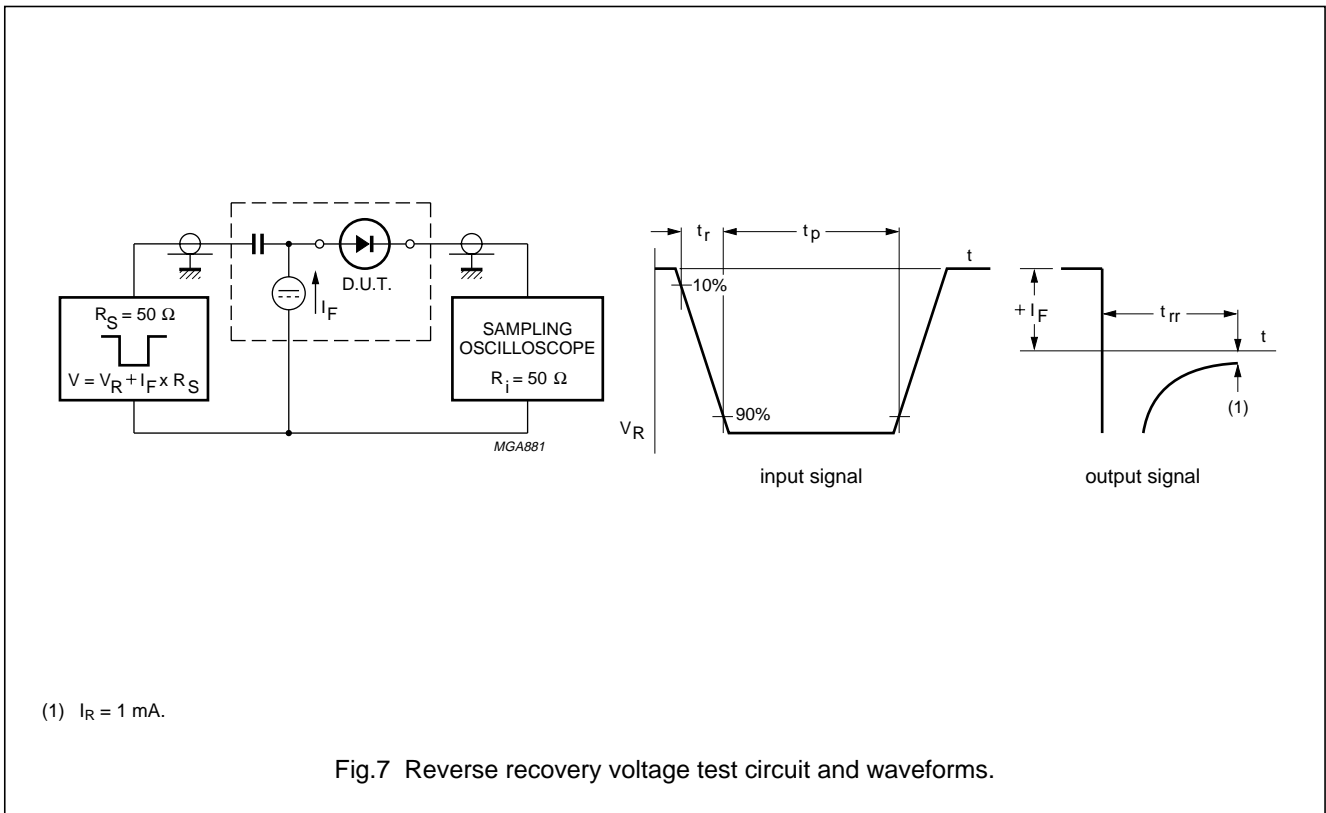

# High-speed double diode

BAW56W

## PACKAGE OUTLINE

Plastic surface mounted package; 3 leads

SOT323

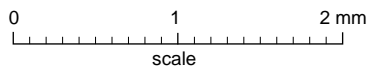
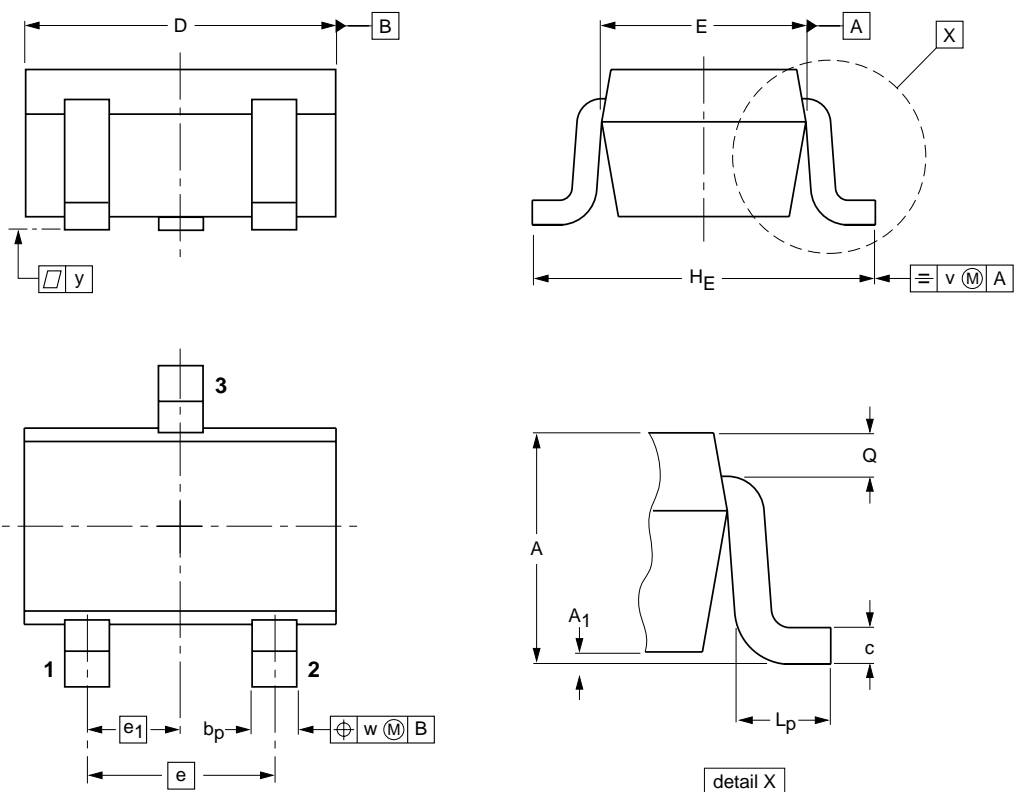

DIMENSIONS (mm are the original dimensions)

UNIT	A	A <sub>1</sub> max	b <sub>p</sub>	c	D	E	e	e <sub>1</sub>	H <sub>E</sub>	L <sub>p</sub>	Q	v	w
mm	1.1 0.8	0.1	0.4 0.3	0.25 0.10	2.2 1.8	1.35 1.15	1.3	0.65	2.2 2.0	0.45 0.15	0.23 0.13	0.2	0.2

OUTLINE VERSION	REFERENCES				EUROPEAN PROJECTION	ISSUE DATE
	IEC	JEDEC	EIAJ			
SOT323			SC-70			97-02-28

## High-speed double diode

BAW56W

**DEFINITIONS**

<b>Data Sheet Status</b>	
Objective specification	This data sheet contains target or goal specifications for product development.
Preliminary specification	This data sheet contains preliminary data; supplementary data may be published later.
Product specification	This data sheet contains final product specifications.
<b>Limiting values</b>	
Limiting values given are in accordance with the Absolute Maximum Rating System (IEC 134). Stress above one or more of the limiting values may cause permanent damage to the device. These are stress ratings only and operation of the device at these or at any other conditions above those given in the Characteristics sections of the specification is not implied. Exposure to limiting values for extended periods may affect device reliability.	
<b>Application information</b>	
Where application information is given, it is advisory and does not form part of the specification.	

**LIFE SUPPORT APPLICATIONS**

These products are not designed for use in life support appliances, devices, or systems where malfunction of these products can reasonably be expected to result in personal injury. Philips customers using or selling these products for use in such applications do so at their own risk and agree to fully indemnify Philips for any damages resulting from such improper use or sale.



High-speed double diode

BAW56W

---

**NOTES**

High-speed double diode

BAW56W

---

**NOTES**

High-speed double diode

BAW56W

---

**NOTES**

# Philips Semiconductors – a worldwide company

**Argentina:** see South America

**Australia:** 34 Waterloo Road, NORTH RYDE, NSW 2113,  
Tel. +61 2 9805 4455, Fax. +61 2 9805 4466

**Austria:** Computerstr. 6, A-1101 WIEN, P.O. Box 213,  
Tel. +43 1 60 101 1248, Fax. +43 1 60 101 1210

**Belarus:** Hotel Minsk Business Center, Bld. 3, r. 1211, Volodarski Str. 6,  
220050 MINSK, Tel. +375 172 20 0733, Fax. +375 172 20 0773

**Belgium:** see The Netherlands

**Brazil:** see South America

**Bulgaria:** Philips Bulgaria Ltd., Energoproject, 15th floor,  
51 James Bourchier Blvd., 1407 SOFIA,  
Tel. +359 2 68 9211, Fax. +359 2 68 9102

**Canada:** PHILIPS SEMICONDUCTORS/COMPONENTS,  
Tel. +1 800 234 7381, Fax. +1 800 943 0087

**China/Hong Kong:** 501 Hong Kong Industrial Technology Centre,  
72 Tat Chee Avenue, Kowloon Tong, HONG KONG,  
Tel. +852 2319 7888, Fax. +852 2319 7700

**Colombia:** see South America

**Czech Republic:** see Austria

**Denmark:** Sydhavnsgade 23, 1780 COPENHAGEN V,  
Tel. +45 33 29 3333, Fax. +45 33 29 3905

**Finland:** Sinikalliontie 3, FIN-02630 ESPOO,  
Tel. +358 9 615 800, Fax. +358 9 6158 0920

**France:** 51 Rue Carnot, BP317, 92156 SURESNES Cedex,  
Tel. +33 1 4099 6161, Fax. +33 1 4099 6427

**Germany:** Hammerbrookstraße 69, D-20097 HAMBURG,  
Tel. +49 40 2353 60, Fax. +49 40 2353 6300

**Hungary:** see Austria

**India:** Philips INDIA Ltd, Band Box Building, 2nd floor,  
254-D, Dr. Annie Besant Road, Worli, MUMBAI 400 025,  
Tel. +91 22 493 8541, Fax. +91 22 493 0966

**Indonesia:** PT Philips Development Corporation, Semiconductors Division,  
Gedung Philips, Jl. Buncit Raya Kav.99-100, JAKARTA 12510,  
Tel. +62 21 794 0040 ext. 2501, Fax. +62 21 794 0080

**Ireland:** Newstead, Clonskeagh, DUBLIN 14,  
Tel. +353 1 7640 000, Fax. +353 1 7640 200

**Israel:** RAPAC Electronics, 7 Kehilat Saloniki St, PO Box 18053,  
TEL AVIV 61180, Tel. +972 3 645 0444, Fax. +972 3 649 1007

**Italy:** PHILIPS SEMICONDUCTORS, Piazza IV Novembre 3,  
20124 MILANO, Tel. +39 02 67 52 2531, Fax. +39 02 67 52 2557

**Japan:** Philips Bldg 13-37, Kohnan 2-chome, Minato-ku,  
TOKYO 108-8507, Tel. +81 3 3740 5130, Fax. +81 3 3740 5077

**Korea:** Philips House, 260-199 Itaewon-dong, Yongsan-ku, SEOUL,  
Tel. +82 2 709 1412, Fax. +82 2 709 1415

**Malaysia:** No. 76 Jalan Universiti, 46200 PETALING JAYA, SELANGOR,  
Tel. +60 3 750 5214, Fax. +60 3 757 4880

**Mexico:** 5900 Gateway East, Suite 200, EL PASO, TEXAS 79905,  
Tel. +9-5 800 234 7381, Fax +9-5 800 943 0087

**Middle East:** see Italy

**Netherlands:** Postbus 90050, 5600 PB EINDHOVEN, Bldg. VB,  
Tel. +31 40 27 82785, Fax. +31 40 27 88399

**New Zealand:** 2 Wagener Place, C.P.O. Box 1041, AUCKLAND,  
Tel. +64 9 849 4160, Fax. +64 9 849 7811

**Norway:** Box 1, Manglerud 0612, OSLO,  
Tel. +47 22 74 8000, Fax. +47 22 74 8341

**Pakistan:** see Singapore

**Philippines:** Philips Semiconductors Philippines Inc.,  
106 Valero St. Salcedo Village, P.O. Box 2108 MCC, MAKATI,  
Metro MANILA, Tel. +63 2 816 6380, Fax. +63 2 817 3474

**Poland:** Ul. Lukiska 10, PL 04-123 WARSZAWA,  
Tel. +48 22 612 2831, Fax. +48 22 612 2327

**Portugal:** see Spain

**Romania:** see Italy

**Russia:** Philips Russia, Ul. Usatcheva 35A, 119048 MOSCOW,  
Tel. +7 095 755 6918, Fax. +7 095 755 6919

**Singapore:** Lorong 1, Toa Payoh, SINGAPORE 319762,  
Tel. +65 350 2538, Fax. +65 251 6500

**Slovakia:** see Austria

**Slovenia:** see Italy

**South Africa:** S.A. PHILIPS Pty Ltd., 195-215 Main Road Martindale,  
2092 JOHANNESBURG, P.O. Box 58088 Newville 2114,  
Tel. +27 11 471 5401, Fax. +27 11 471 5398

**South America:** Al. Vicente Pinzon, 173, 6th floor,  
04547-130 SÃO PAULO, SP, Brazil,  
Tel. +55 11 821 2333, Fax. +55 11 821 2382

**Spain:** Balmes 22, 08007 BARCELONA,  
Tel. +34 93 301 6312, Fax. +34 93 301 4107

**Sweden:** Kottbygatan 7, Akalla, S-16485 STOCKHOLM,  
Tel. +46 8 5985 2000, Fax. +46 8 5985 2745

**Switzerland:** Allmendstrasse 140, CH-8027 ZÜRICH,  
Tel. +41 1 488 2741 Fax. +41 1 488 3263

**Taiwan:** Philips Semiconductors, 6F, No. 96, Chien Kuo N. Rd., Sec. 1,  
TAIPEI, Taiwan Tel. +886 2 2134 2886, Fax. +886 2 2134 2874

**Thailand:** PHILIPS ELECTRONICS (THAILAND) Ltd.,  
209/2 Sanpavuth-Bangna Road Prakanong, BANGKOK 10260,  
Tel. +66 2 745 4090, Fax. +66 2 398 0793

**Turkey:** Yukari Dudullu, Org. San. Blg., 2.Cad. Nr. 28 81260 Umraniye,  
ISTANBUL, Tel. +90 216 522 1500, Fax. +90 216 522 1813

**Ukraine:** PHILIPS UKRAINE, 4 Patrice Lumumba str., Building B, Floor 7,  
252042 KIEV, Tel. +380 44 264 2776, Fax. +380 44 268 0461

**United Kingdom:** Philips Semiconductors Ltd., 276 Bath Road, Hayes,  
MIDDLESEX UB3 5BX, Tel. +44 181 730 5000, Fax. +44 181 754 8421

**United States:** 811 East Arques Avenue, SUNNYVALE, CA 94088-3409,  
Tel. +1 800 234 7381, Fax. +1 800 943 0087

**Uruguay:** see South America

**Vietnam:** see Singapore

**Yugoslavia:** PHILIPS, Trg N. Pasica 5/v, 11000 BEOGRAD,  
Tel. +381 11 62 5344, Fax. +381 11 63 5777

**For all other countries apply to:** Philips Semiconductors,  
International Marketing & Sales Communications, Building BE-p, P.O. Box 218,  
5600 MD EINDHOVEN, The Netherlands, Fax. +31 40 27 24825

**Internet:** <http://www.semiconductors.philips.com>

© Philips Electronics N.V. 1999

SCA 64

All rights are reserved. Reproduction in whole or in part is prohibited without the prior written consent of the copyright owner.

The information presented in this document does not form part of any quotation or contract, is believed to be accurate and reliable and may be changed without notice. No liability will be accepted by the publisher for any consequence of its use. Publication thereof does not convey nor imply any license under patent- or other industrial or intellectual property rights.

Printed in The Netherlands

115002/00/04/pp12

Date of release: 1999 May 11

Document order number: 9397 750 05949

*Let's make things better.*

**Philips  
Semiconductors**



**PHILIPS**