

DATA SHEET

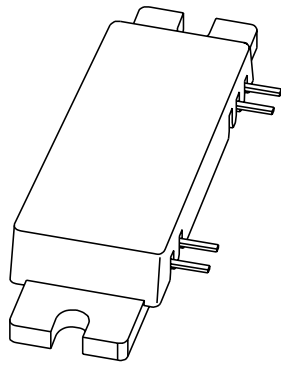

BGY925/5 UHF amplifier module

Preliminary specification

1999 Jul 30

UHF amplifier module

BGY925/5

FEATURES

- 26 V nominal supply voltage
- 23 W output power into a load of 50 Ω with an RF drive power of 36 mW.

APPLICATIONS

- Base station transmitting equipment operating in the 920 to 960 MHz frequency range.

DESCRIPTION

The BGY925A is a three-stage UHF amplifier module in a SOT365A package. It consists of one NPN silicon planar transistor die and two silicon MOSFET dies mounted on a metallized ceramic AlN substrate, together with matching and bias circuitry.

PINNING - SOT365A

PIN	DESCRIPTION
1	RF input
2	V _{S1}
3	V _{S2}
4	RF output
Flange	ground

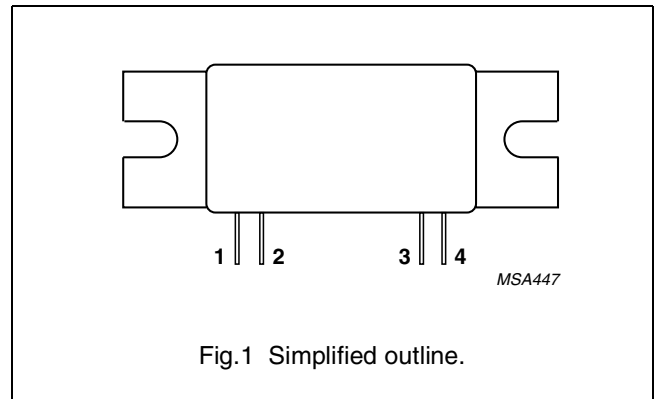

QUICK REFERENCE DATA

RF performance at T_{mb} = 25 °C.

MODE OF OPERATION	f (MHz)	V _{S1} (V)	V _{S2} (V)	P _L (W)	G _p (dB)	η (%) (note 1)	Z _s , Z _L (Ω)
CW	920 to 960	5	26	23	≥28	≥30	50

Note

1. At P_L = 16 W.

UHF amplifier module

BGY925/5

LIMITING VALUES

In accordance with the Absolute Maximum Rating System (IEC 134).

SYMBOL	PARAMETER	MIN.	MAX.	UNIT
V _{S1}	DC supply voltage	–	28	V
V _{S2}	DC supply voltage	–	28	V
P _D	input drive power	–	80	mW
P _L	load power	–	32	W
T _{stg}	storage temperature	–30	+100	°C
T _{mb}	operating mounting-base temperature	–10	+90	°C

CHARACTERISTICSZ_S = Z_L = 50 Ω; P_L = 23 W; V_{S1} = 5 V; V_{S2} = 26 V; T_{mb} = 25 °C; unless otherwise specified.

SYMBOL	PARAMETER	CONDITIONS	MIN.	TYP.	MAX.	UNIT
f	frequency range		920	–	960	MHz
I _{S1}	supply current		–	50	–	mA
I _{S2}	supply current	P _D < –60 dBm	–	500	–	mA
P _L	load power		23	–	–	W
G _p	power gain	160 mW ≤ P _L ≤ 23 W	28	30	32	dB
	out of band gain	P _L = 160 mW; f < 920 MHz; f > 960 MHz	–	–	1.5	dB
ΔG _p	in-band gain variation	f = 920 MHz - 960 MHz	–	–	1.5	dB
G _{P1} - G _{P2}	gain expansion	G _{P1} at P _L = 160 mW; G _{P2} at P _L = 5 W	–	–	±0.75	dB
η	efficiency	P _L = 16 W	30	–	–	%
H ₂	second harmonic	P _L = 16 W	–	–	–35	dBc
H ₃	third harmonic	P _L = 16 W	–	–	–40	dBc
VSWR _{in}	input VSWR		–	–	2:1	
	stability	VSWR ≤ 3 : 1 through all phases; V _{S2} = 26 to 27 V; P _L = 23 W	–	–	–60	dBc
	reverse intermodulation	P _{carrier} = 16 W; P _{interference} = 1.6 μW; f _i = f _c ± 600 kHz	–	–80	–	dBc
	direct intermodulation	P _{carrier} = 16 W; P _{interference} = 1.6 mW; f _i = f _c + 270 kHz	–	–55	–	dBc
NF	noise figure				8	dBc
B	AM bandwidth	corner frequency = 3 dB; P _{carrier} = 16 W; modulation = 20%	2	–	–	MHz
	ruggedness	VSWR ≤ 5 : 1 through all phases; V _{S2} = 26 V; P _L = 23 W	no degradation			

UHF amplifier module

BGY925/5

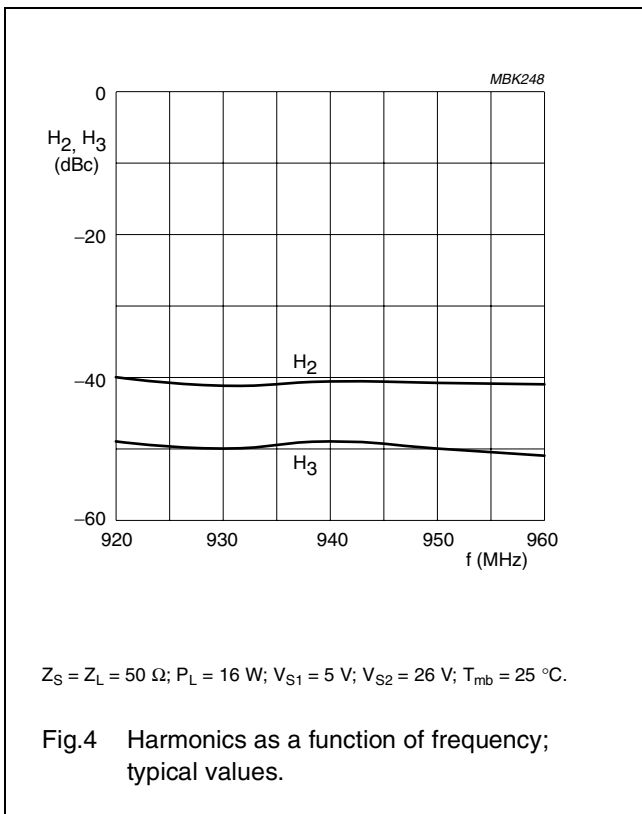
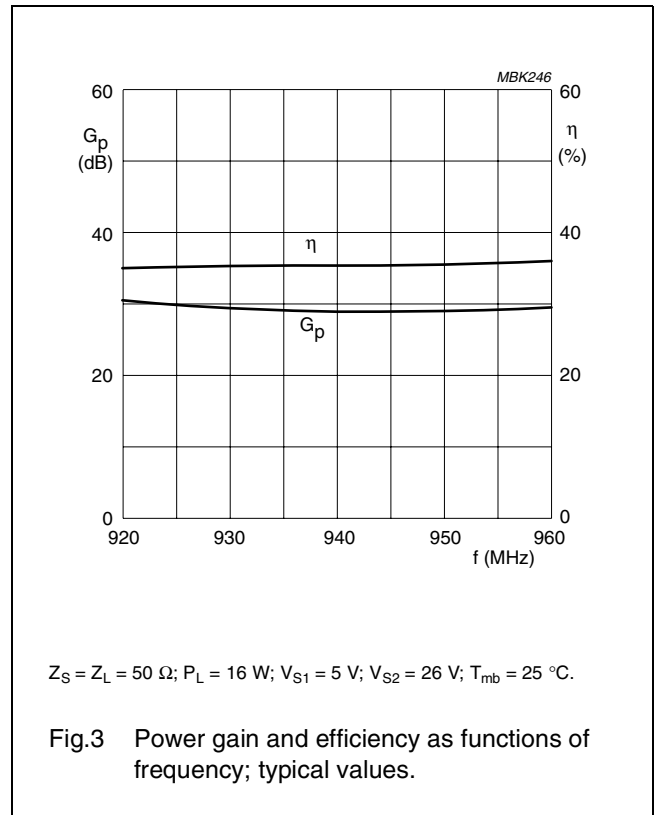
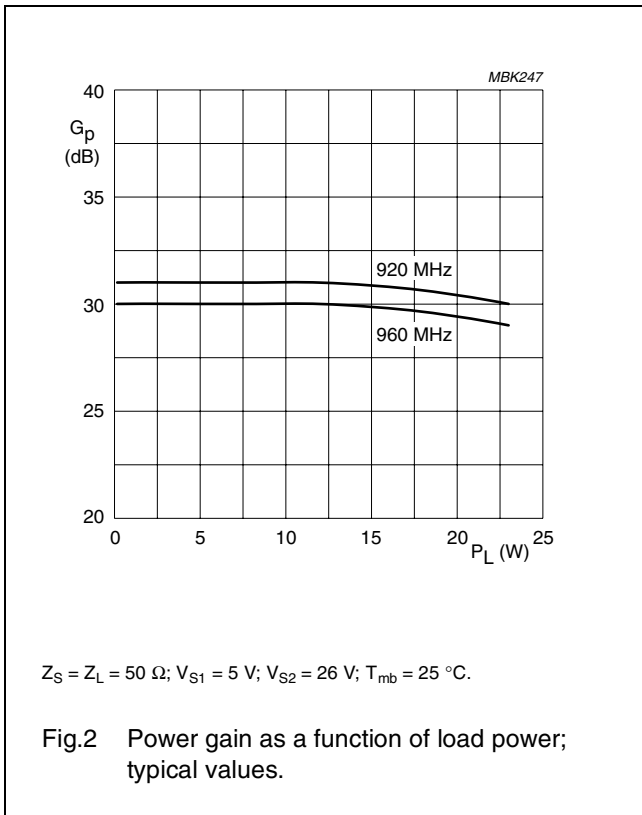

UHF amplifier module

BGY925/5

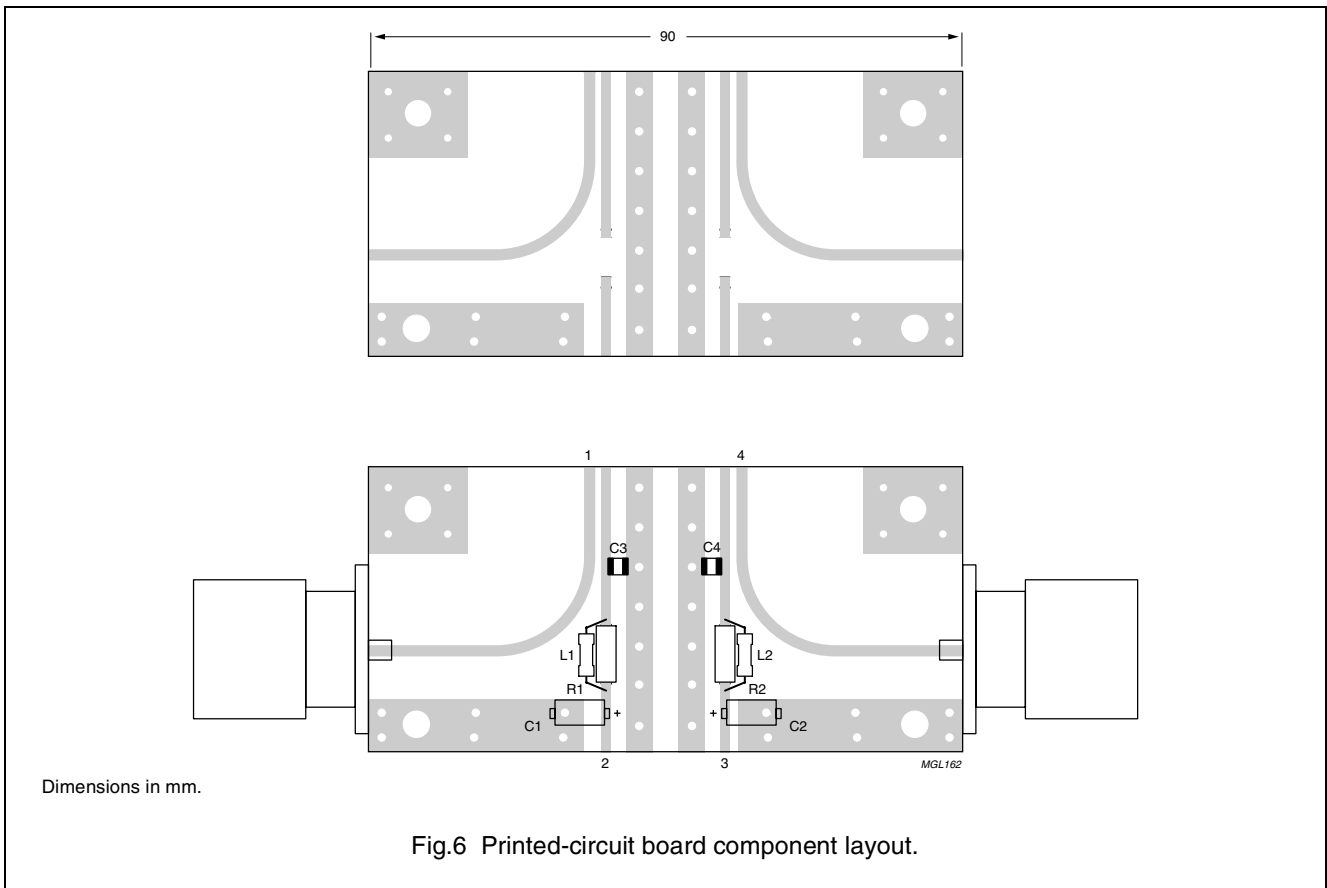
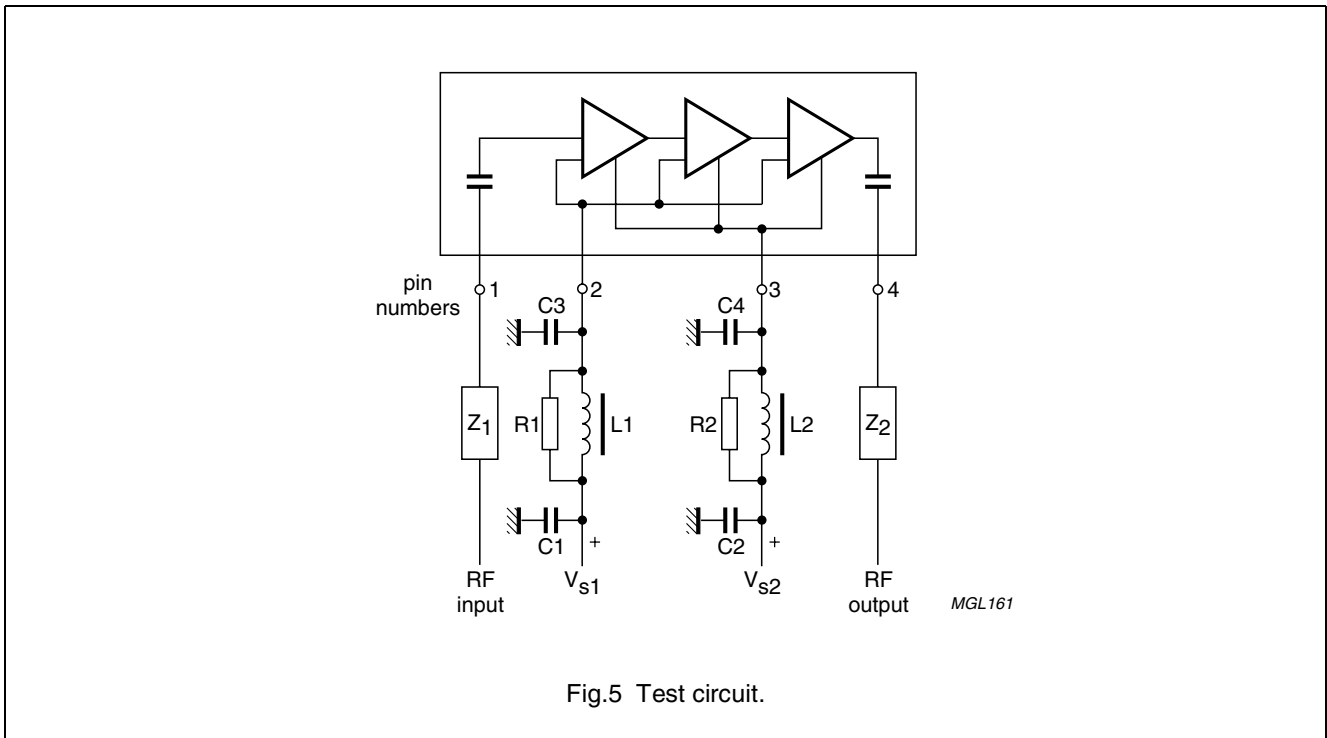

UHF amplifier module

BGY925/5

List of components (See Figs 5 and 6)

COMPONENT	DESCRIPTION	VALUE	CATALOGUE NO.
C1, C2	electrolytic capacitor	10 μ F; 35 V	
C3, C4	multilayer ceramic chip capacitor	100 nF; 50 V	
L1, L2	Grade 4S2 Ferroxcube bead		4330 030 36300
R1, R2	metal film resistor	10 Ω ; 0.4 W	2322 195 13109
Z ₁ , Z ₂	stripline; note 1	50 Ω	

Note

1. The striplines are on a double copper-clad printed-circuit board with epoxy dielectric ($\epsilon_r = 4.5$); thickness = 1 mm.

MOUNTING RECOMMENDATIONS

To ensure a good thermal contact and to prevent mechanical stress when bolted down, the flatness of the mounting base is designed to be typically better than 0.1 mm. The mounting area of the heatsink should be flat and free from burrs and loose particles. The heatsink should be rigid and not prone to bowing under thermal cycling conditions. The thickness of a solid heatsink should be not less than 5 mm to ensure a rigid assembly.

A thin, even layer of thermal compound should be applied between the mounting base and the heatsink to achieve the best possible thermal contact resistance. Excessive use of thermal compound will result in an increase in thermal resistance and possible bowing of the

mounting-base; too little will also result in poor thermal conduction.

The module should be mounted to the heatsink using 3 mm bolts with flat washers. The bolts should first be tightened to "finger tight" and then further tightened in alternating steps to a maximum torque of 0.4 to 0.6 Nm.

Once mounted on the heatsink, the module leads can be soldered to the printed-circuit board. A soldering iron may be used up to a temperature of 250 °C for a maximum of 10 seconds at a distance of 2 mm from the plastic cap.

ESD precautions must be taken to protect the device from electrostatic damage.

UHF amplifier module

BGY925/5

PACKAGE OUTLINE

Plastic rectangular single-ended flat package; flange mounted; 2 mounting holes; 4 in-line leads SOT365A

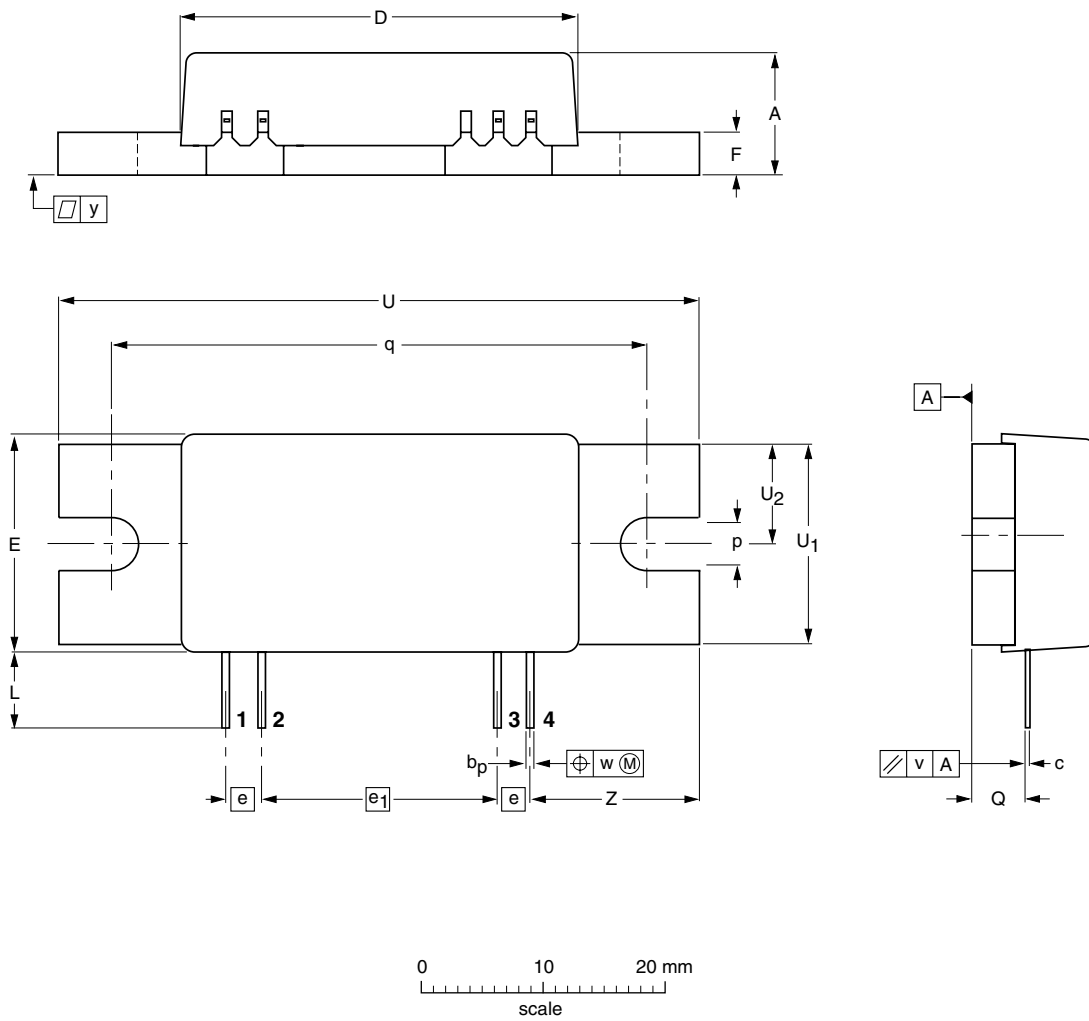

DIMENSIONS (mm are the original dimensions)

UNIT	A	b _p	c	D	E	e	e ₁	F	L	p	Q	q	U	U ₁	U ₂	v	w	y	Z
mm	9.5	0.56	0.3	30.1	18.6	2.54	17.78	3.25	6.5	4.1	4.0	40.74	48.0	15.4	7.75	0.3	0.25	0.1	12.8
	9.0	0.46	0.2	29.9	18.4			3.15	6.1	3.9	3.8	40.54	48.4	15.2	7.55				12.6

OUTLINE VERSION	REFERENCES				EUROPEAN PROJECTION	ISSUE DATE
	IEC	JEDEC	EIAJ			
SOT365A						99-02-06

UHF amplifier module

BGY925/5

DEFINITIONS

Data Sheet Status	
Objective specification	This data sheet contains target or goal specifications for product development.
Preliminary specification	This data sheet contains preliminary data; supplementary data may be published later.
Product specification	This data sheet contains final product specifications.
Limiting values	
Limiting values given are in accordance with the Absolute Maximum Rating System (IEC 134). Stress above one or more of the limiting values may cause permanent damage to the device. These are stress ratings only and operation of the device at these or at any other conditions above those given in the Characteristics sections of the specification is not implied. Exposure to limiting values for extended periods may affect device reliability.	
Application information	
Where application information is given, it is advisory and does not form part of the specification.	

LIFE SUPPORT APPLICATIONS

These products are not designed for use in life support appliances, devices, or systems where malfunction of these products can reasonably be expected to result in personal injury. Philips customers using or selling these products for use in such applications do so at their own risk and agree to fully indemnify Philips for any damages resulting from such improper use or sale.

Philips Semiconductors – a worldwide company

Argentina: see South America

Australia: 34 Waterloo Road, NORTH RYDE, NSW 2113,
Tel. +61 2 9805 4455, Fax. +61 2 9805 4466

Austria: Computerstr. 6, A-1101 WIEN, P.O. Box 213,
Tel. +43 1 60 101 1248, Fax. +43 1 60 101 1210

Belarus: Hotel Minsk Business Center, Bld. 3, r. 1211, Volodarski Str. 6,
220050 MINSK, Tel. +375 172 20 0733, Fax. +375 172 20 0773

Belgium: see The Netherlands

Brazil: see South America

Bulgaria: Philips Bulgaria Ltd., Energoproject, 15th floor,
51 James Bourchier Blvd., 1407 SOFIA,
Tel. +359 2 68 9211, Fax. +359 2 68 9102

Canada: PHILIPS SEMICONDUCTORS/COMPONENTS,
Tel. +1 800 234 7381, Fax. +1 800 943 0087

China/Hong Kong: 501 Hong Kong Industrial Technology Centre,
72 Tat Chee Avenue, Kowloon Tong, HONG KONG,
Tel. +852 2319 7888, Fax. +852 2319 7700

Colombia: see South America

Czech Republic: see Austria

Denmark: Sydhavnsgade 23, 1780 COPENHAGEN V,
Tel. +45 33 29 3333, Fax. +45 33 29 3905

Finland: Sinikalliontie 3, FIN-02630 ESPOO,
Tel. +358 9 615 800, Fax. +358 9 6158 0920

France: 51 Rue Carnot, BP317, 92156 SURESNES Cedex,
Tel. +33 1 4099 6161, Fax. +33 1 4099 6427

Germany: Hammerbrookstraße 69, D-20097 HAMBURG,
Tel. +49 40 2353 60, Fax. +49 40 2353 6300

Hungary: see Austria

India: Philips INDIA Ltd, Band Box Building, 2nd floor,
254-D, Dr. Annie Besant Road, Worli, MUMBAI 400 025,
Tel. +91 22 493 8541, Fax. +91 22 493 0966

Indonesia: PT Philips Development Corporation, Semiconductors Division,
Gedung Philips, Jl. Buncit Raya Kav.99-100, JAKARTA 12510,
Tel. +62 21 794 0040 ext. 2501, Fax. +62 21 794 0080

Ireland: Newstead, Clonskeagh, DUBLIN 14,
Tel. +353 1 7640 000, Fax. +353 1 7640 200

Israel: RAPAC Electronics, 7 Kehilat Saloniki St, PO Box 18053,
TEL AVIV 61180, Tel. +972 3 645 0444, Fax. +972 3 649 1007

Italy: PHILIPS SEMICONDUCTORS, Piazza IV Novembre 3,
20124 MILANO, Tel. +39 02 67 52 2531, Fax. +39 02 67 52 2557

Japan: Philips Bldg 13-37, Kohnan 2-chome, Minato-ku,
TOKYO 108-8507, Tel. +81 3 3740 5130, Fax. +81 3 3740 5057

Korea: Philips House, 260-199 Itaewon-dong, Yongsan-ku, SEOUL,
Tel. +82 2 709 1412, Fax. +82 2 709 1415

Malaysia: No. 76 Jalan Universiti, 46200 PETALING JAYA, SELANGOR,
Tel. +60 3 750 5214, Fax. +60 3 757 4880

Mexico: 5900 Gateway East, Suite 200, EL PASO, TEXAS 79905,
Tel. +9-5 800 234 7381, Fax +9-5 800 943 0087

Middle East: see Italy

Netherlands: Postbus 90050, 5600 PB EINDHOVEN, Bldg. VB,
Tel. +31 40 27 82785, Fax. +31 40 27 88399

New Zealand: 2 Wagener Place, C.P.O. Box 1041, AUCKLAND,
Tel. +64 9 849 4160, Fax. +64 9 849 7811

Norway: Box 1, Manglerud 0612, OSLO,
Tel. +47 22 74 8000, Fax. +47 22 74 8341

Pakistan: see Singapore

Philippines: Philips Semiconductors Philippines Inc.,
106 Valero St. Salcedo Village, P.O. Box 2108 MCC, MAKATI,
Metro MANILA, Tel. +63 2 816 6380, Fax. +63 2 817 3474

Poland: Ul. Lukiska 10, PL 04-123 WARSZAWA,
Tel. +48 22 612 2831, Fax. +48 22 612 2327

Portugal: see Spain

Romania: see Italy

Russia: Philips Russia, Ul. Usatcheva 35A, 119048 MOSCOW,
Tel. +7 095 755 6918, Fax. +7 095 755 6919

Singapore: Lorong 1, Toa Payoh, SINGAPORE 319762,
Tel. +65 350 2538, Fax. +65 251 6500

Slovakia: see Austria

Slovenia: see Italy

South Africa: S.A. PHILIPS Pty Ltd., 195-215 Main Road Martindale,
2092 JOHANNESBURG, P.O. Box 58088 Newville 2114,
Tel. +27 11 471 5401, Fax. +27 11 471 5398

South America: Al. Vicente Pinzon, 173, 6th floor,
04547-130 SÃO PAULO, SP, Brazil,
Tel. +55 11 821 2333, Fax. +55 11 821 2382

Spain: Balmes 22, 08007 BARCELONA,
Tel. +34 93 301 6312, Fax. +34 93 301 4107

Sweden: Kottbygatan 7, Akalla, S-16485 STOCKHOLM,
Tel. +46 8 5985 2000, Fax. +46 8 5985 2745

Switzerland: Allmendstrasse 140, CH-8027 ZÜRICH,
Tel. +41 1 488 2741 Fax. +41 1 488 3263

Taiwan: Philips Semiconductors, 6F, No. 96, Chien Kuo N. Rd., Sec. 1,
TAIPEI, Taiwan Tel. +886 2 2134 2886, Fax. +886 2 2134 2874

Thailand: PHILIPS ELECTRONICS (THAILAND) Ltd.,
209/2 Sanpavuth-Bangna Road Prakanong, BANGKOK 10260,
Tel. +66 2 745 4090, Fax. +66 2 398 0793

Turkey: Yukari Dudullu, Org. San. Blg., 2.Cad. Nr. 28 81260 Umraniye,
ISTANBUL, Tel. +90 216 522 1500, Fax. +90 216 522 1813

Ukraine: PHILIPS UKRAINE, 4 Patrice Lumumba str., Building B, Floor 7,
252042 KIEV, Tel. +380 44 264 2776, Fax. +380 44 268 0461

United Kingdom: Philips Semiconductors Ltd., 276 Bath Road, Hayes,
MIDDLESEX UB3 5BX, Tel. +44 208 730 5000, Fax. +44 208 754 8421

United States: 811 East Arques Avenue, SUNNYVALE, CA 94088-3409,
Tel. +1 800 234 7381, Fax. +1 800 943 0087

Uruguay: see South America

Vietnam: see Singapore

Yugoslavia: PHILIPS, Trg N. Pasica 5/v, 11000 BEOGRAD,
Tel. +381 11 62 5344, Fax. +381 11 63 5777

For all other countries apply to: Philips Semiconductors,
International Marketing & Sales Communications, Building BE-p, P.O. Box 218,
5600 MD EINDHOVEN, The Netherlands, Fax. +31 40 27 24825

Internet: <http://www.semiconductors.philips.com>

© Philips Electronics N.V.

SCA6

All rights are reserved. Reproduction in whole or in part is prohibited without the prior written consent of the copyright owner.

The information presented in this document does not form part of any quotation or contract, is believed to be accurate and reliable and may be changed without notice. No liability will be accepted by the publisher for any consequence of its use. Publication thereof does not convey nor imply any license under patent- or other industrial or intellectual property rights.

Printed in The Netherlands

budgetnum/printrun/ed/pp9

Date of release: 1999 Jul 30

Document order number: 9397 750 06167

Let's make things better.

**Philips
Semiconductors**



PHILIPS