

TIPL761, TIPL761A NPN SILICON POWER TRANSISTORS

Copyright © 1997, Power Innovations Limited, UK

AUGUST 1978 - REVISED MARCH 1997

- Rugged Triple-Diffused Planar Construction
- 4 A Continuous Collector Current
- Operating Characteristics Fully Guaranteed at 100°C
- 1000 Volt Blocking Capability
- 100 W at 25°C Case Temperature



Pin 2 is in electrical contact with the mounting base.

MDTRAA

absolute maximum ratings at 25°C case temperature (unless otherwise noted)

RATING		SYMBOL	VALUE	UNIT
Collector-base voltage ($I_E = 0$)	TIPL761	V_{CBO}	850	V
	TIPL761A		1000	
Collector-emitter voltage ($V_{BE} = 0$)	TIPL761	V_{CES}	850	V
	TIPL761A		1000	
Collector-emitter voltage ($I_B = 0$)	TIPL761	V_{CEO}	400	V
	TIPL761A		450	
Emitter-base voltage		V_{EBO}	10	V
Continuous collector current		I_C	4	A
Peak collector current (see Note 1)		I_{CM}	8	A
Continuous device dissipation at (or below) 25°C case temperature		P_{tot}	100	W
Operating junction temperature range		T_j	-65 to +150	°C
Storage temperature range		T_{stg}	-65 to +150	°C

NOTE 1: This value applies for $t_p \leq 10$ ms, duty cycle $\leq 2\%$.

PRODUCT INFORMATION

Information is current as of publication date. Products conform to specifications in accordance with the terms of Power Innovations standard warranty. Production processing does not necessarily include testing of all parameters.

TIPL761, TIPL761A

NPN SILICON POWER TRANSISTORS

AUGUST 1978 - REVISED MARCH 1997

electrical characteristics at 25°C case temperature (unless otherwise noted)

PARAMETER	TEST CONDITIONS			MIN	TYP	MAX	UNIT
$V_{CEO(sus)}$ Collector-emitter sustaining voltage	$I_C = 10\text{ mA}$	$L = 25\text{ mH}$	(see Note 2)	TIPL761 400 TIPL761A 450			V
I_{CES} Collector-emitter cut-off current	$V_{CE} = 850\text{ V}$	$V_{BE} = 0$		TIPL761		50	μA
	$V_{CE} = 1000\text{ V}$	$V_{BE} = 0$		TIPL761A		50	
	$V_{CE} = 850\text{ V}$	$V_{BE} = 0$	$T_C = 100^\circ\text{C}$	TIPL761		200	
	$V_{CE} = 1000\text{ V}$	$V_{BE} = 0$	$T_C = 100^\circ\text{C}$	TIPL761A		200	
I_{CEO} Collector cut-off current	$V_{CE} = 400\text{ V}$	$I_B = 0$		TIPL761		50	μA
	$V_{CE} = 450\text{ V}$	$I_B = 0$		TIPL761A		50	
I_{EBO} Emitter cut-off current	$V_{EB} = 10\text{ V}$	$I_C = 0$				1	mA
h_{FE} Forward current transfer ratio	$V_{CE} = 5\text{ V}$	$I_C = 0.5\text{ A}$	(see Notes 3 and 4)	20		60	
$V_{CE(sat)}$ Collector-emitter saturation voltage	$I_B = 0.5\text{ A}$	$I_C = 2.5\text{ A}$				1.0	V
	$I_B = 0.8\text{ A}$	$I_C = 4\text{ A}$	(see Notes 3 and 4)			2.5	
	$I_B = 0.8\text{ A}$	$I_C = 4\text{ A}$	$T_C = 100^\circ\text{C}$			5.0	
$V_{BE(sat)}$ Base-emitter saturation voltage	$I_B = 0.5\text{ A}$	$I_C = 2.5\text{ A}$				1.2	V
	$I_B = 0.8\text{ A}$	$I_C = 4\text{ A}$	(see Notes 3 and 4)			1.4	
	$I_B = 0.8\text{ A}$	$I_C = 4\text{ A}$	$T_C = 100^\circ\text{C}$			1.3	
f_t Current gain bandwidth product	$V_{CE} = 10\text{ V}$	$I_C = 0.5\text{ A}$	$f = 1\text{ MHz}$		12		MHz
C_{ob} Output capacitance	$V_{CB} = 20\text{ V}$	$I_E = 0$	$f = 0.1\text{ MHz}$		110		pF

NOTES: 2. Inductive loop switching measurement.

3. These parameters must be measured using pulse techniques, $t_p = 300\text{ }\mu\text{s}$, duty cycle $\leq 2\%$.

4. These parameters must be measured using voltage-sensing contacts, separate from the current carrying contacts.

thermal characteristics

PARAMETER	MIN	TYP	MAX	UNIT
$R_{\theta JC}$ Junction to case thermal resistance			1.25	$^\circ\text{C/W}$

inductive-load-switching characteristics at 25°C case temperature (unless otherwise noted)

PARAMETER	TEST CONDITIONS †			MIN	TYP	MAX	UNIT
t_{sv} Voltage storage time	$I_C = 4\text{ A}$ $V_{BE(off)} = -5\text{ V}$	$I_{B(on)} = 0.8\text{ A}$	(see Figures 1 and 2)			2.5	μs
t_{rv} Voltage rise time						300	ns
t_{fi} Current fall time						250	ns
t_{ti} Current tail time						150	ns
t_{xo} Cross over time						400	ns
t_{sv} Voltage storage time	$I_C = 4\text{ A}$ $V_{BE(off)} = -5\text{ V}$	$I_{B(on)} = 0.8\text{ A}$	(see Figures 1 and 2)			3	μs
t_{rv} Voltage rise time						500	ns
t_{fi} Current fall time						250	ns
t_{ti} Current tail time						150	ns
t_{xo} Cross over time						750	ns

† Voltage and current values shown are nominal; exact values vary slightly with transistor parameters.

PARAMETER MEASUREMENT INFORMATION

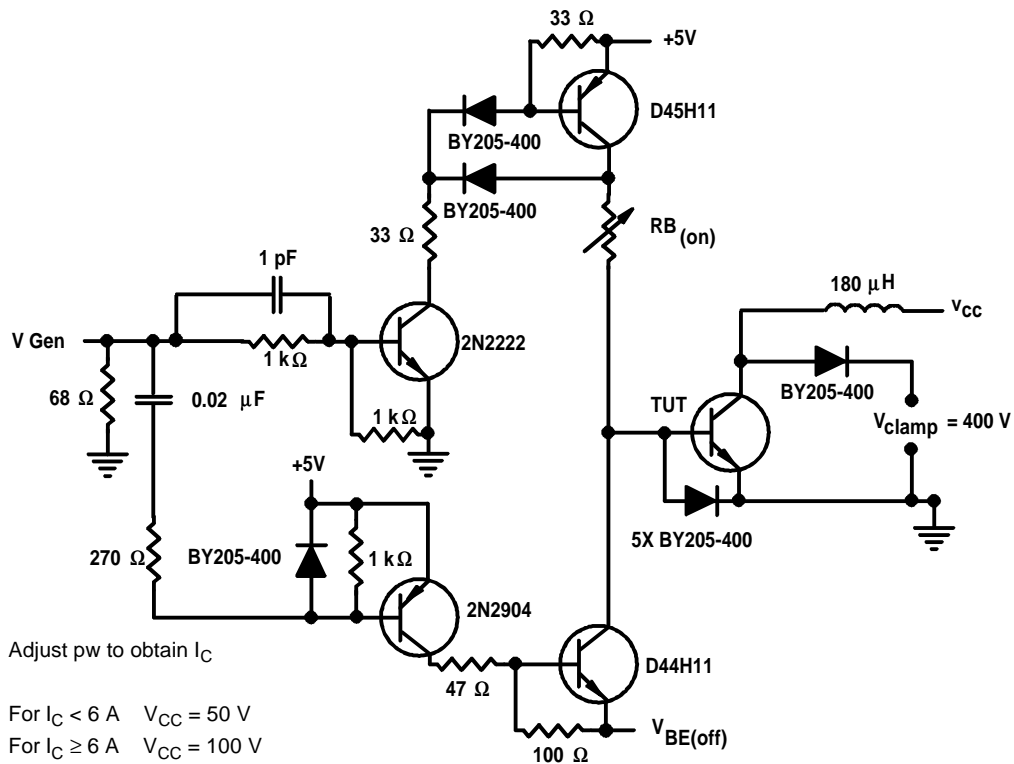
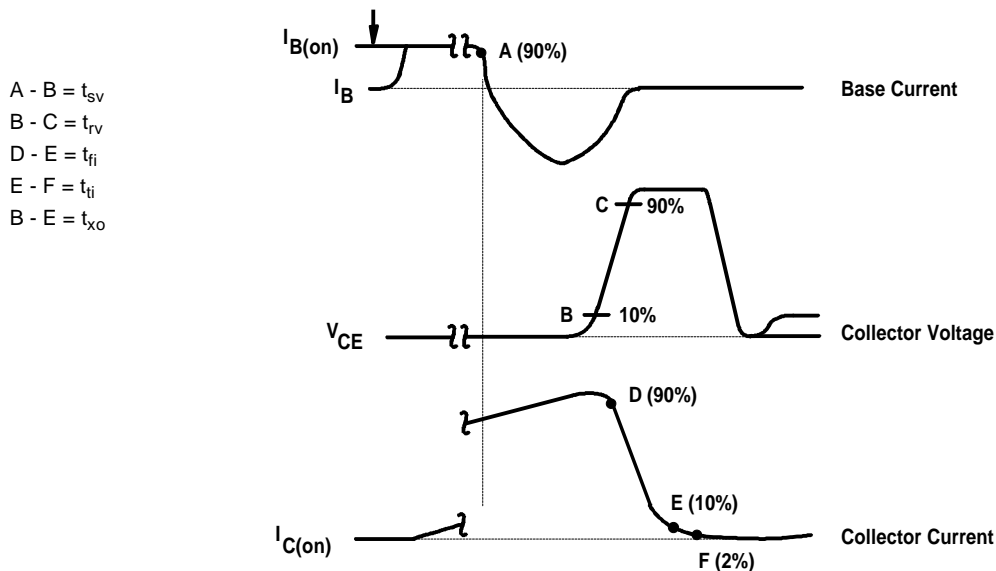

Figure 1. Inductive-Load Switching Test Circuit



NOTES: A. Waveforms are monitored on an oscilloscope with the following characteristics: $t_r < 15$ ns, $R_{in} > 10$ Ω , $C_{in} < 11.5$ pF.
B. Resistors must be noninductive types.

Figure 2. Inductive-Load Switching Waveforms

TIPL761, TIPL761A NPN SILICON POWER TRANSISTORS

AUGUST 1978 - REVISED MARCH 1997

TYPICAL CHARACTERISTICS

TYPICAL DC CURRENT GAIN
VS
COLLECTOR CURRENT

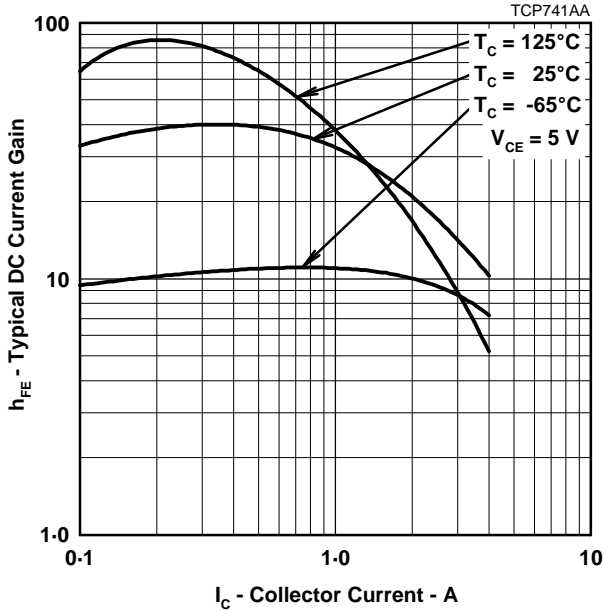

Figure 3.

COLLECTOR-EMITTER SATURATION VOLTAGE
VS
BASE CURRENT

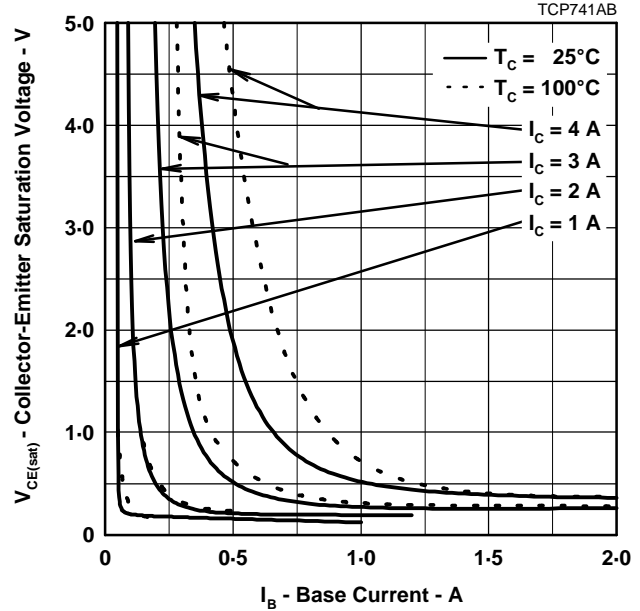

Figure 4.

BASE-EMITTER SATURATION VOLTAGE
VS
BASE CURRENT

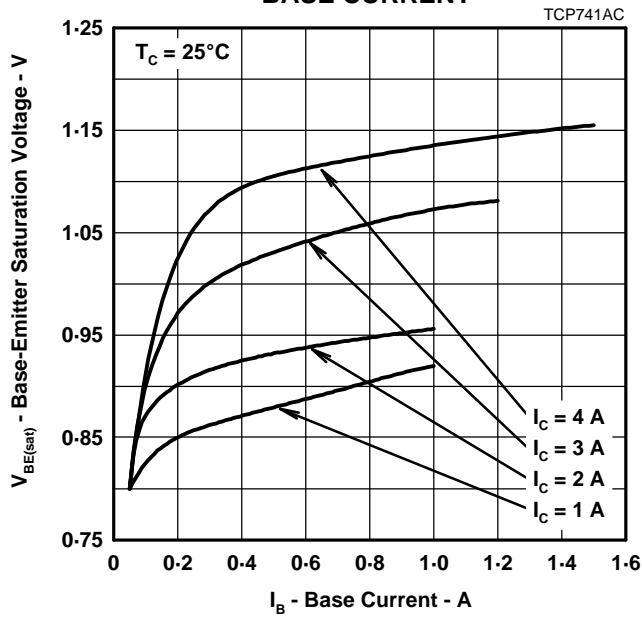

Figure 5.

COLLECTOR CUT-OFF CURRENT
VS
CASE TEMPERATURE

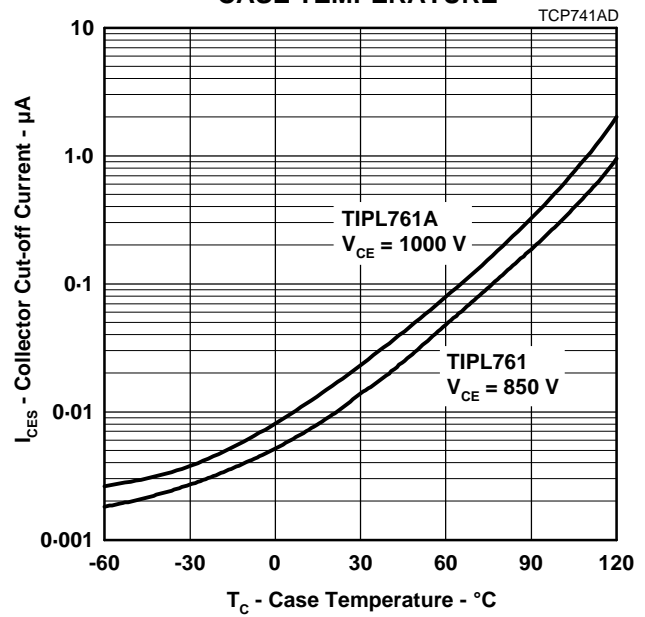

Figure 6.

MAXIMUM SAFE OPERATING REGIONS

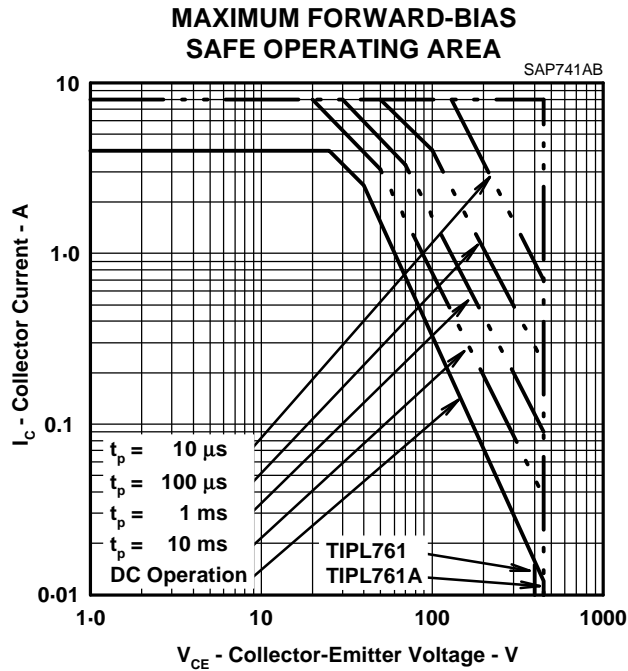

Figure 7.

THERMAL INFORMATION

THERMAL RESPONSE JUNCTION TO CASE
VS
POWER PULSE DURATION

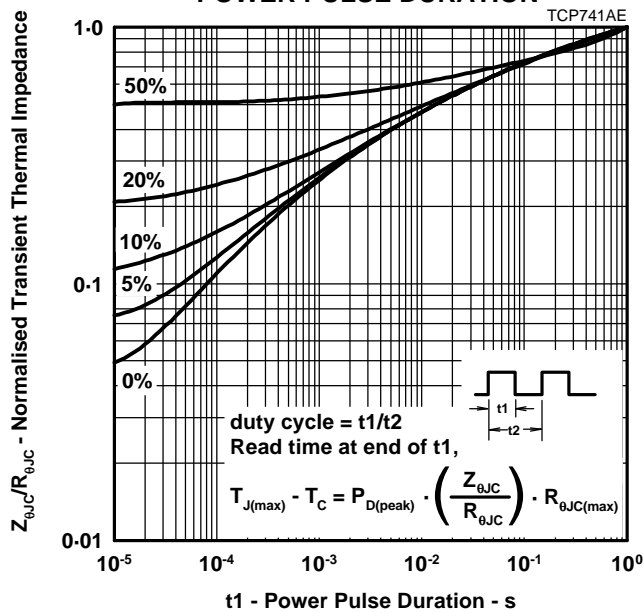

Figure 8.

TIPL761, TIPL761A NPN SILICON POWER TRANSISTORS

AUGUST 1978 - REVISED MARCH 1997

MECHANICAL DATA

SOT-93

3-pin plastic flange-mount package

This single-in-line package consists of a circuit mounted on a lead frame and encapsulated within a plastic compound. The compound will withstand soldering temperature with no deformation, and circuit performance characteristics will remain stable when operated in high humidity conditions. Leads require no additional cleaning or processing when used in soldered assembly.

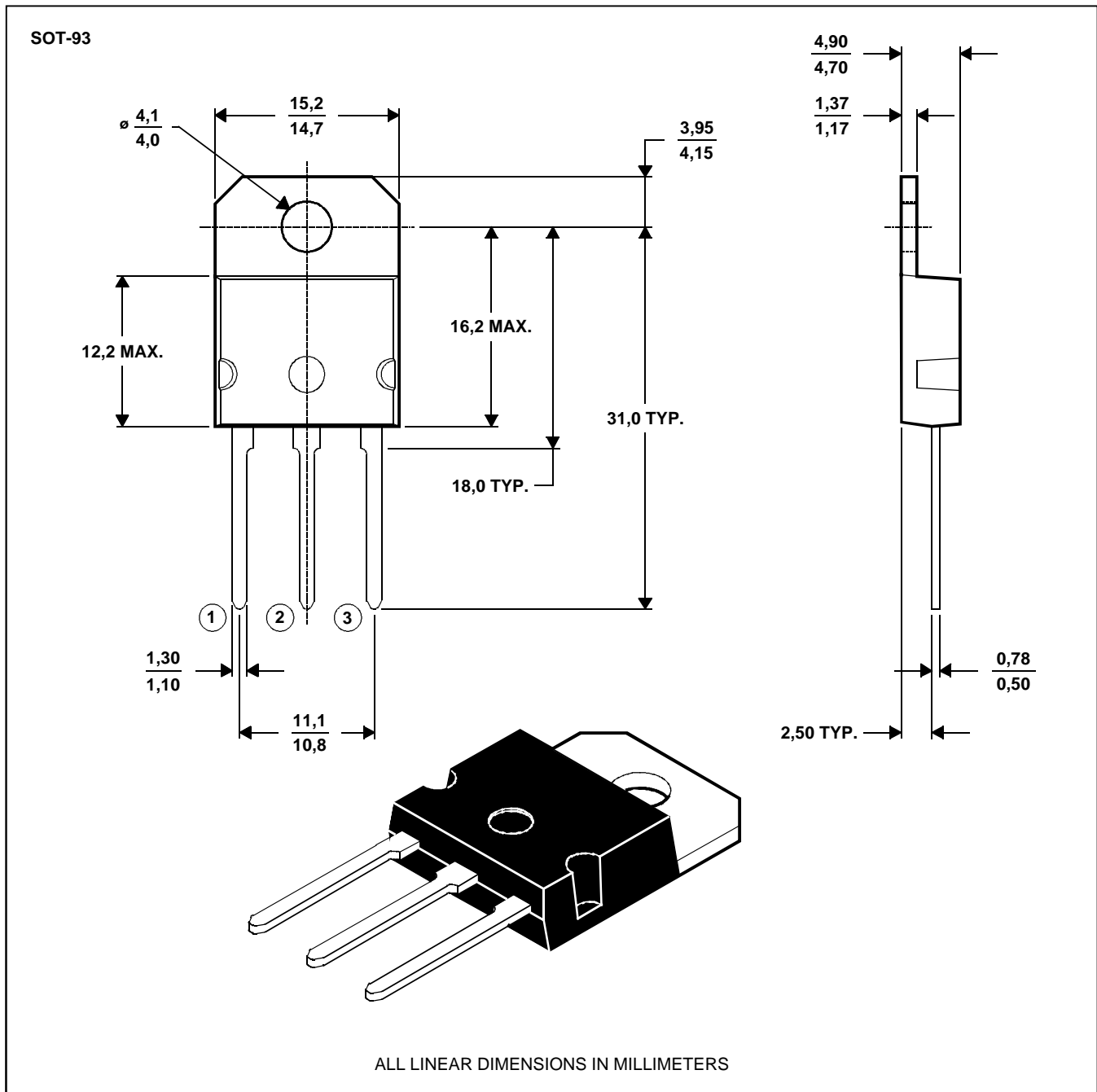

NOTE A: The centre pin is in electrical contact with the mounting tab.

MDXXAW

PRODUCT INFORMATION

IMPORTANT NOTICE

Power Innovations Limited (PI) reserves the right to make changes to its products or to discontinue any semiconductor product or service without notice, and advises its customers to verify, before placing orders, that the information being relied on is current.

PI warrants performance of its semiconductor products to the specifications applicable at the time of sale in accordance with PI's standard warranty. Testing and other quality control techniques are utilized to the extent PI deems necessary to support this warranty. Specific testing of all parameters of each device is not necessarily performed, except as mandated by government requirements.

PI accepts no liability for applications assistance, customer product design, software performance, or infringement of patents or services described herein. Nor is any license, either express or implied, granted under any patent right, copyright, design right, or other intellectual property right of PI covering or relating to any combination, machine, or process in which such semiconductor products or services might be or are used.

PI SEMICONDUCTOR PRODUCTS ARE NOT DESIGNED, INTENDED, AUTHORIZED, OR WARRANTED TO BE SUITABLE FOR USE IN LIFE-SUPPORT APPLICATIONS, DEVICES OR SYSTEMS.

Copyright © 1997, Power Innovations Limited