

- High Current Triacs
- 20 A RMS
- Glass Passivated Wafer
- 400 V to 800 V Off-State Voltage
- 150 A Peak Current
- Max I_{GT} of 50 mA (Quadrants 1 - 3)

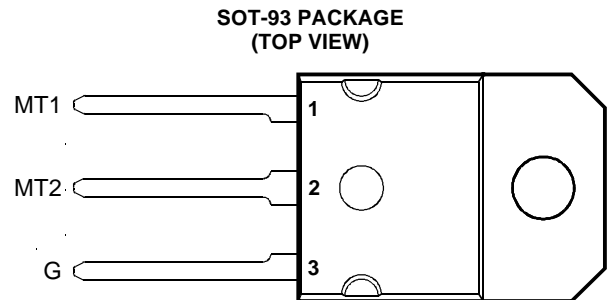

Pin 2 is in electrical contact with the mounting base.

MDC2AD

absolute maximum ratings over operating case temperature (unless otherwise noted)

RATING		SYMBOL	VALUE	UNIT
Repetitive peak off-state voltage (see Note 1)	TIC253D	V_{DRM}	400	V
	TIC253M		600	
	TIC253S		700	
	TIC253N		800	
Full-cycle RMS on-state current at (or below) 70°C case temperature (see Note 2)		$I_{T(RMS)}$	20	A
Peak on-state surge current full-sine-wave (see Note 3)		I_{TSM}	150	A
Peak gate current		I_{GM}	±1	A
Operating case temperature range		T_C	-40 to +110	°C
Storage temperature range		T_{stg}	-40 to +125	°C
Lead temperature 1.6 mm from case for 10 seconds		T_L	230	°C

- NOTES: 1. These values apply bidirectionally for any value of resistance between the gate and Main Terminal 1.
 2. This value applies for 50-Hz full-sine-wave operation with resistive load. Above 70°C derate linearly to 110°C case temperature at the rate of 500 mA/°C.
 3. This value applies for one 50-Hz full-sine-wave when the device is operating at (or below) the rated value of peak reverse voltage and on-state current. Surge may be repeated after the device has returned to original thermal equilibrium.

electrical characteristics at 25°C case temperature (unless otherwise noted)

PARAMETER	TEST CONDITIONS			MIN	TYP	MAX	UNIT
I_{DRM} Repetitive peak off-state current	$V_D = \text{Rated } V_{DRM}$	$I_G = 0$	$T_C = 110^\circ\text{C}$			±2	mA
I_{GTM} Peak gate trigger current	$V_{supply} = +12\text{ V}^\dagger$	$R_L = 10\ \Omega$	$t_{p(g)} > 20\ \mu\text{s}$		7	50	mA
	$V_{supply} = +12\text{ V}^\dagger$	$R_L = 10\ \Omega$	$t_{p(g)} > 20\ \mu\text{s}$		-15	-50	
	$V_{supply} = -12\text{ V}^\dagger$	$R_L = 10\ \Omega$	$t_{p(g)} > 20\ \mu\text{s}$		-16	-50	
	$V_{supply} = -12\text{ V}^\dagger$	$R_L = 10\ \Omega$	$t_{p(g)} > 20\ \mu\text{s}$		28		
V_{GTM} Peak gate trigger voltage	$V_{supply} = +12\text{ V}^\dagger$	$R_L = 10\ \Omega$	$t_{p(g)} > 20\ \mu\text{s}$		0.7	2	V
	$V_{supply} = +12\text{ V}^\dagger$	$R_L = 10\ \Omega$	$t_{p(g)} > 20\ \mu\text{s}$		-0.7	-2	
	$V_{supply} = -12\text{ V}^\dagger$	$R_L = 10\ \Omega$	$t_{p(g)} > 20\ \mu\text{s}$		-0.8	-2	
	$V_{supply} = -12\text{ V}^\dagger$	$R_L = 10\ \Omega$	$t_{p(g)} > 20\ \mu\text{s}$		0.8	2	
V_{TM} Peak on-state voltage	$I_{TM} = \pm 28.2\text{ A}$	$I_G = 50\text{ mA}$	(see Note 4)		±1.4	±1.7	V
I_H Holding current	$V_{supply} = +12\text{ V}^\dagger$	$I_G = 0$	Init' $I_{TM} = 100\text{ mA}$		6	40	mA
	$V_{supply} = -12\text{ V}^\dagger$	$I_G = 0$	Init' $I_{TM} = -100\text{ mA}$		-13	-40	

† All voltages are with respect to Main Terminal 1.

NOTE 4: This parameter must be measured using pulse techniques, $t_p \leq 1\text{ ms}$, duty cycle $\leq 2\%$. Voltage-sensing contacts separate from the current carrying contacts are located within 3.2 mm from the device body.

PRODUCT INFORMATION

Information is current as of publication date. Products conform to specifications in accordance with the terms of Power Innovations standard warranty. Production processing does not necessarily include testing of all parameters.

TIC253 SERIES SILICON TRIACS

DECEMBER 1971 - REVISED MARCH 1997

electrical characteristics at 25°C case temperature (unless otherwise noted) (continued)

PARAMETER	TEST CONDITIONS	MIN	TYP	MAX	UNIT
I_L Latching current	$V_{supply} = +12 V \dagger$ $V_{supply} = -12 V \dagger$ (see Note 5)		20 -20		mA
dv/dt Critical rate of rise of off-state voltage	$V_D = \text{Rated } V_D$ $I_G = 0$ $T_C = 110^\circ C$		± 450		V/ μs
dv/dt _(c) Critical rise of commutation voltage	$V_D = \text{Rated } V_D$ $di/dt = 0.5 I_{T(RMS)}/ms$ $T_C = 80^\circ C$ $I_T = 1.4 I_{T(RMS)}$		± 1		V/ μs
di/dt Critical rate of rise of on-state current	$V_D = \text{Rated } V_D$ $di_G/dt = 50 \text{ mA}/\mu s$ $I_{GT} = 50 \text{ mA}$ $T_C = 110^\circ C$		± 200		A/ μs

† All voltages are with respect to Main Terminal 1.

NOTE 5: The triacs are triggered by a 15-V (open-circuit amplitude) pulse supplied by a generator with the following characteristics:

$R_G = 100 \Omega$, $t_{p(g)} = 20 \mu s$, $t_r = \leq 15 \text{ ns}$, $f = 1 \text{ kHz}$.

thermal characteristics

PARAMETER	MIN	TYP	MAX	UNIT
$R_{\theta JC}$ Junction to case thermal resistance			1.52	$^\circ C/W$
$R_{\theta JA}$ Junction to free air thermal resistance			36	$^\circ C/W$

TYPICAL CHARACTERISTICS

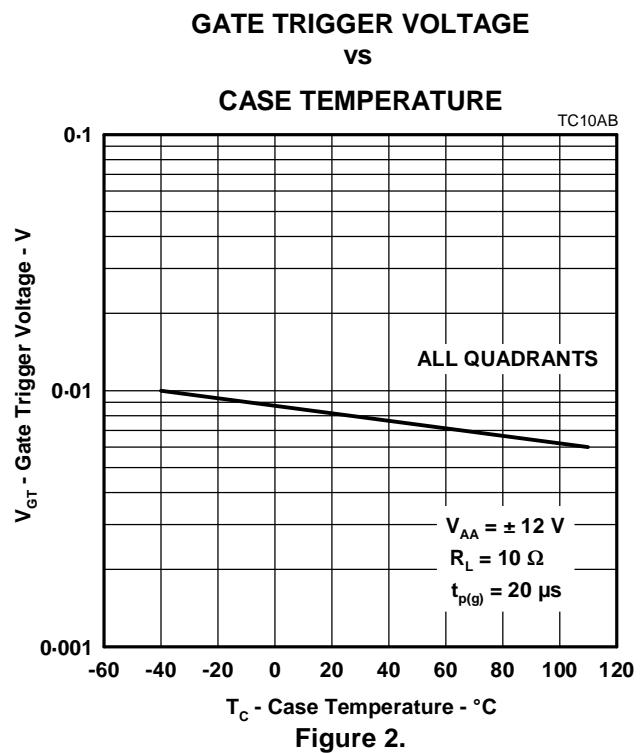
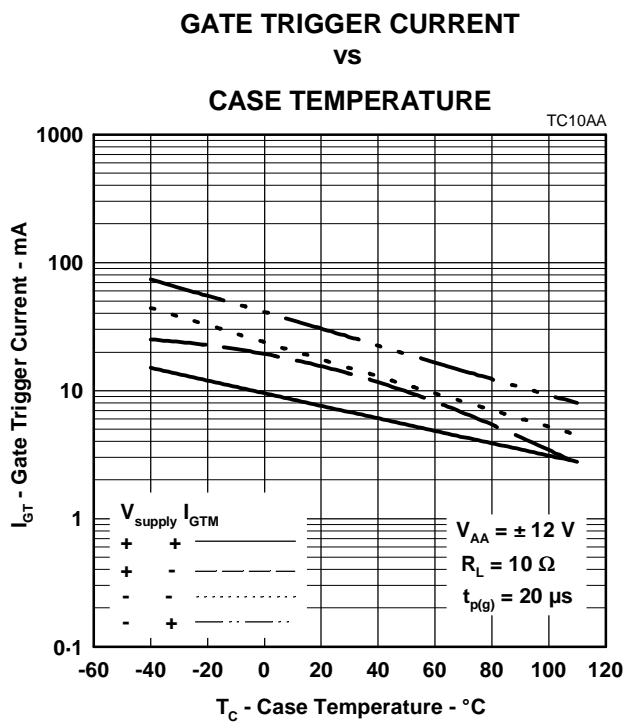

TYPICAL CHARACTERISTICS

HOLDING CURRENT
vs
CASE TEMPERATURE

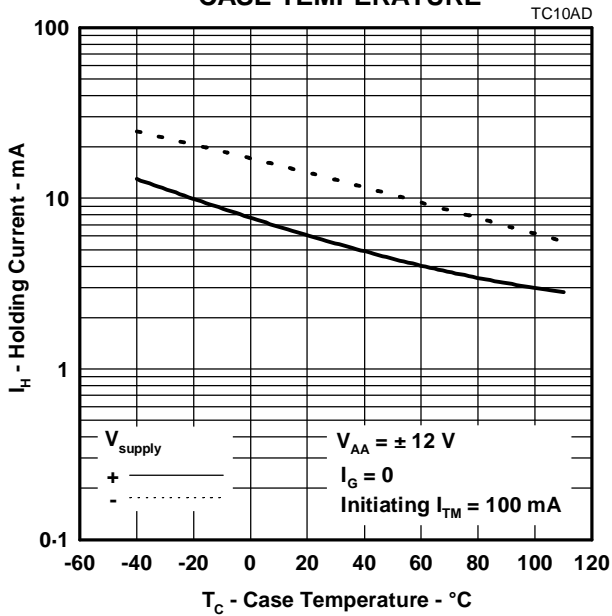

Figure 3.

GATE FORWARD VOLTAGE
vs
GATE FORWARD CURRENT

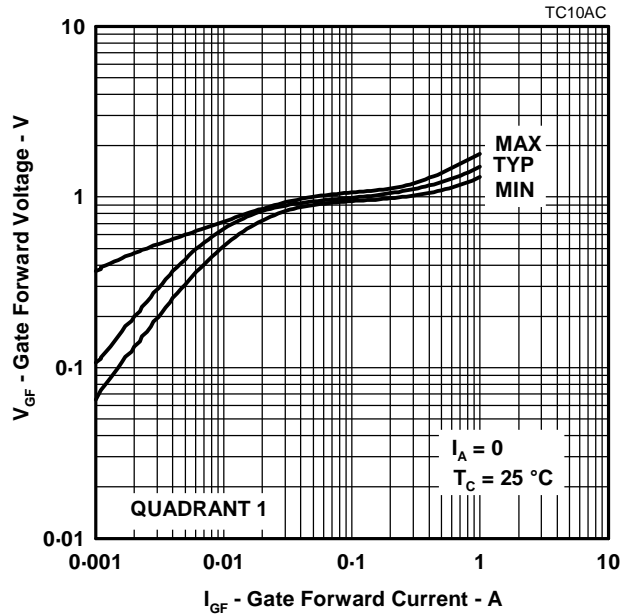

Figure 4.

LATCHING CURRENT
vs
CASE TEMPERATURE

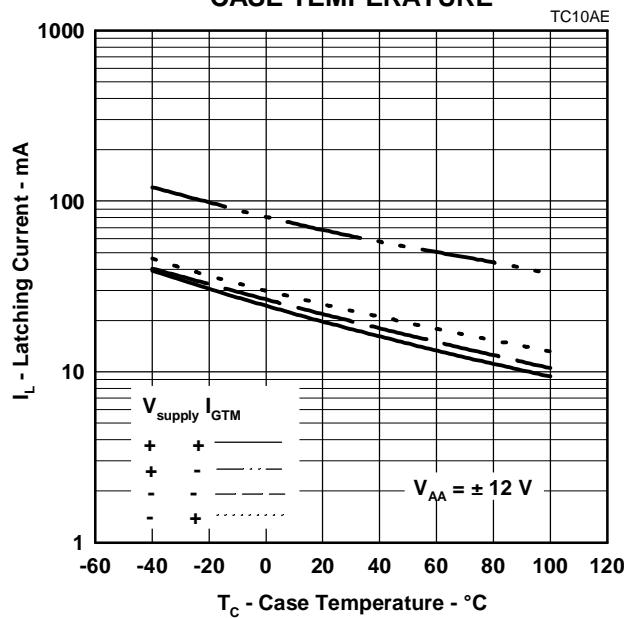

Figure 5.

TIC253 SERIES SILICON TRIACS

DECEMBER 1971 - REVISED MARCH 1997

MECHANICAL DATA

SOT-93

3-pin plastic flange-mount package

This single-in-line package consists of a circuit mounted on a lead frame and encapsulated within a plastic compound. The compound will withstand soldering temperature with no deformation, and circuit performance characteristics will remain stable when operated in high humidity conditions. Leads require no additional cleaning or processing when used in soldered assembly.

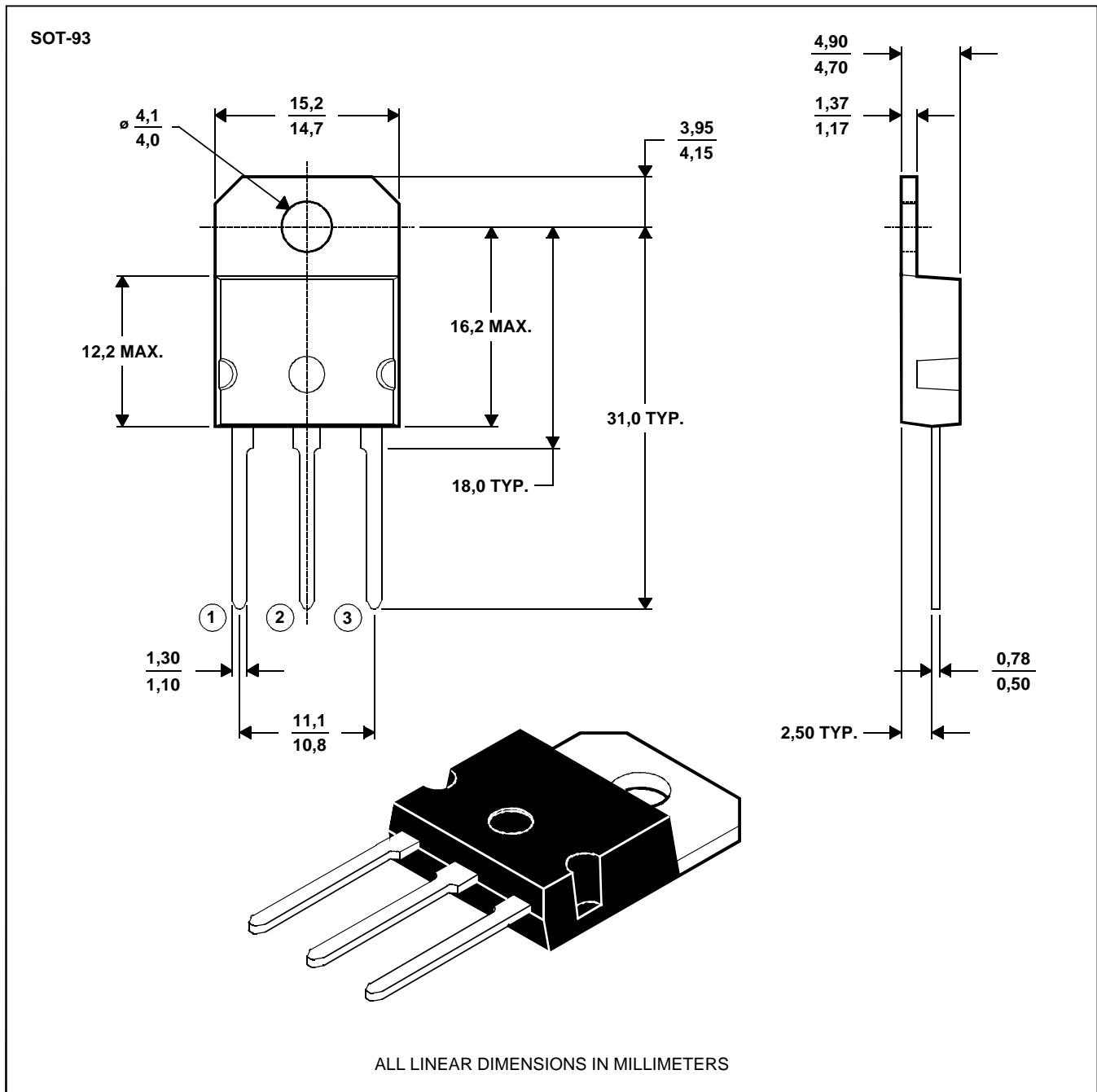

NOTE A: The centre pin is in electrical contact with the mounting tab.

MDXXAW

PRODUCT INFORMATION

IMPORTANT NOTICE

Power Innovations Limited (PI) reserves the right to make changes to its products or to discontinue any semiconductor product or service without notice, and advises its customers to verify, before placing orders, that the information being relied on is current.

PI warrants performance of its semiconductor products to the specifications applicable at the time of sale in accordance with PI's standard warranty. Testing and other quality control techniques are utilized to the extent PI deems necessary to support this warranty. Specific testing of all parameters of each device is not necessarily performed, except as mandated by government requirements.

PI accepts no liability for applications assistance, customer product design, software performance, or infringement of patents or services described herein. Nor is any license, either express or implied, granted under any patent right, copyright, design right, or other intellectual property right of PI covering or relating to any combination, machine, or process in which such semiconductor products or services might be or are used.

PI SEMICONDUCTOR PRODUCTS ARE NOT DESIGNED, INTENDED, AUTHORIZED, OR WARRANTED TO BE SUITABLE FOR USE IN LIFE-SUPPORT APPLICATIONS, DEVICES OR SYSTEMS.

Copyright © 1997, Power Innovations Limited