

## LOW CAPACITANCE TVS ARRAY

### APPLICATIONS

- ✓ T1/E1
- ✓ RS-422, RS-423 & RS-485
- ✓ SDH/SONET, ATM Equipment & Systems
- ✓ Industrial Controls & Monitoring
- ✓ Cable Modem Intra-Building Protection

### IEC COMPATIBILITY (EN61000-4)

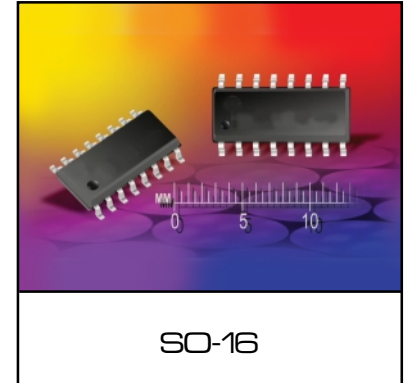
- ✓ 61000-4-2 (ESD): Air - 15kV, Contact - 8kV
- ✓ 61000-4-4 (EFT): 40A - 5/50ns
- ✓ 61000-4-5 (Surge): 8/20 $\mu$ s - 95A, L4(Line-Gnd) & 48A, L4(Line-Line) & 83A, L2(Power)

### FEATURES

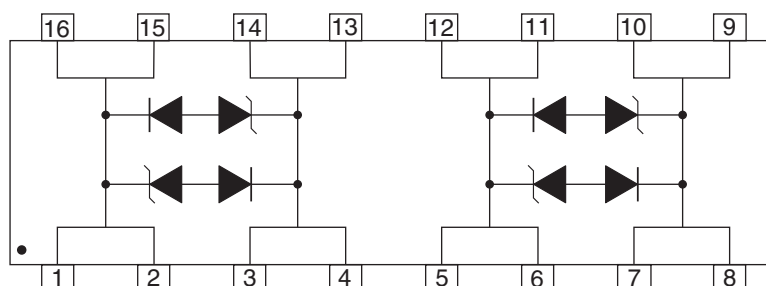
- ✓ 3,600 Watts Peak Pulse Power per Line (tp=8/20 $\mu$ s)
- ✓ 600 Watts Peak Pulse Power per Line (tp=10/1000 $\mu$ s)
- ✓ 100A (2/10 $\mu$ s) per Bellcore GR-1089 (Intra-Building)
- ✓ Bidirectional Configuration
- ✓ High Surge Capability: 80A (10/1000 $\mu$ s)
- ✓ Available in 2 Voltages: 6.5V & 12V
- ✓ Protects Two (2) Bidirectional Lines
- ✓ **LOW CAPACITANCE: < 30pF per LINE PAIR**

### MECHANICAL CHARACTERISTICS

- ✓ Molded JEDEC SO-16 Package
- ✓ Weight 0.15 grams (Approximate)
- ✓ Flammability rating UL 94V-0
- ✓ 16mm Tape and Reel Per EIA Standard 481
- ✓ Marking: Logo, Part Number, Date Code & Pin One Defined By Dot on Top of Package



### PIN CONFIGURATION

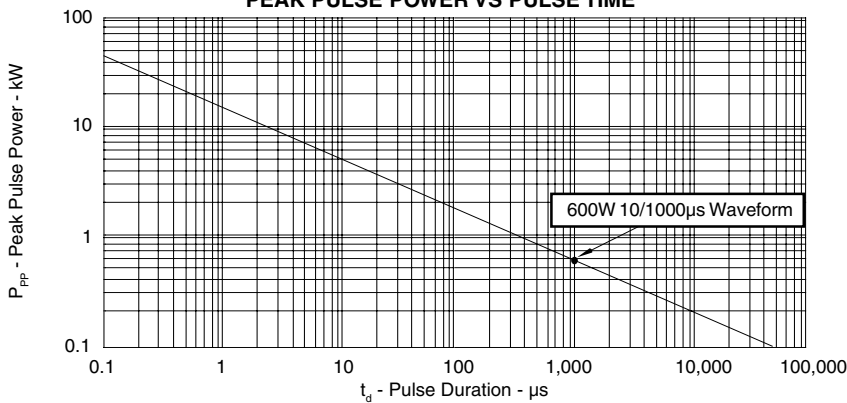


**DEVICE CHARACTERISTICS**

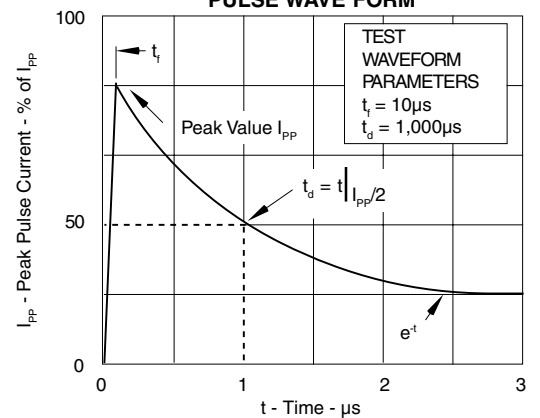
MAXIMUM RATINGS @ 25°C Unless Otherwise Specified			
PARAMETER	SYMBOL	VALUE	UNITS
Peak Pulse Power ( $t_p = 8/20\mu s$ )	$P_{PP}$	3,600	Watts
Peak Pulse Power ( $t_p = 10/1000\mu s$ ) - See Figure 1	$P_{PP}$	600	Watts
Operating Temperature	$T_J$	-55°C to 150°C	°C
Storage Temperature	$T_{STG}$	-55°C to 150°C	°C

ELECTRICAL CHARACTERISTICS PER LINE @ 25°C Unless Otherwise Specified					
PART NUMBER	RATED STAND-OFF VOLTAGE  $V_{WM}$ VOLTS	MINIMUM BREAKDOWN VOLTAGE  @ 1mA $V_{(BR)}$ VOLTS	MAXIMUM LEAKAGE CURRENT  @ $V_{WM}$ $I_D$ $\mu A$	MAXIMUM CLAMPING VOLTAGE (See Fig. 2) @ $I_{PP} = 10A$ $V_C$ VOLTS	TYPICAL CAPACITANCE  @ 0V, 1MHz C pF
SMLC6.5C-2	6.5	7.2	300	12.4	30
SMLC12C-2	12.0	13.3	2	19.9	30

**FIGURE 1  
PEAK PULSE POWER VS PULSE TIME**

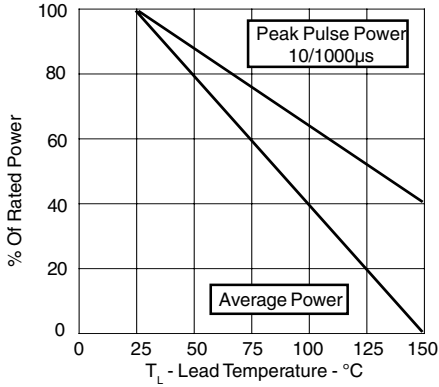


**FIGURE 2  
PULSE WAVE FORM**

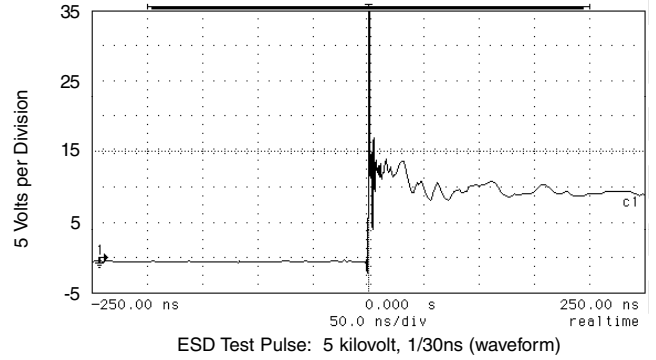


**GRAPHS**

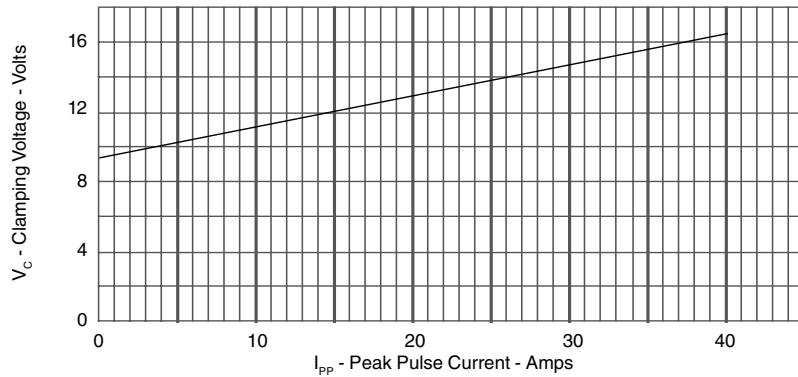
**FIGURE 3  
 POWER DERATING CURVE**



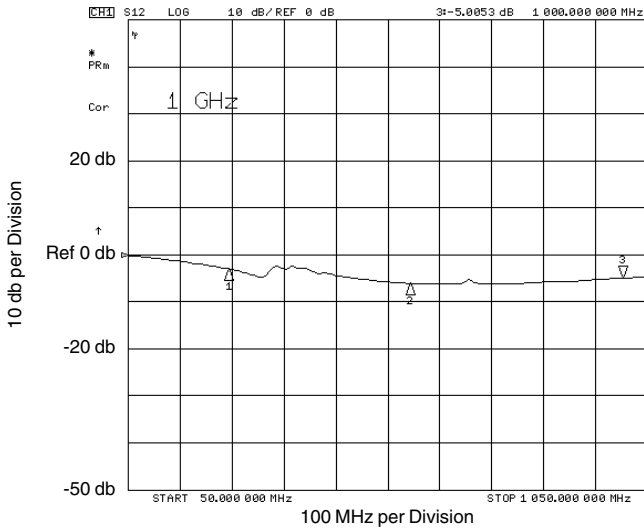
**FIGURE 4  
 OVERSHOOT & CLAMPING VOLTAGE FOR SMLC6.5C-2**



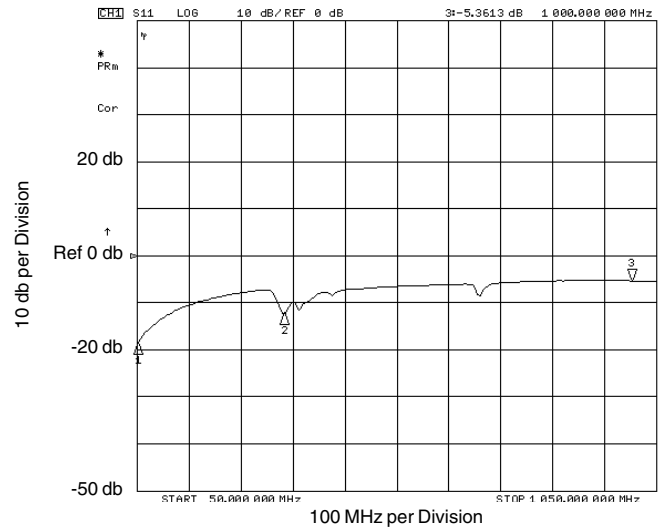
**FIGURE 5  
 TYPICAL CLAMPING VOLTAGE VS PEAK PULSE CURRENT FOR SMLC6.5C-2**



**FIGURE 6  
 INSERTION LOSS - SMLC6.5C-2**



**FIGURE 7  
 RETURN LOSS - SMLC6.5C-2**



## APPLICATION NOTE

The SMLCxxC-2 Series are low capacitance, bidirectional TVS arrays that are designed to protect I/O or high speed data lines from the damaging effects of ESD or EFT. This product series has a surge capability of 600 Watts  $P_{pp}$  per line for an 10/1000 $\mu$ s waveform and ESD protection > 40kV.

### **BIDIRECTIONAL DIFFERENTIAL-MODE CONFIGURATION(Figure 1)**

Ideal for use multimode transceiver I/O lines, telecommunications and wireless circuits, the SMLCxxC-2 Series provides up to two (2) line pairs of protection in a differential-mode T1/E1 application as depicted in Figure 1.

Circuit connectivity is as follows:

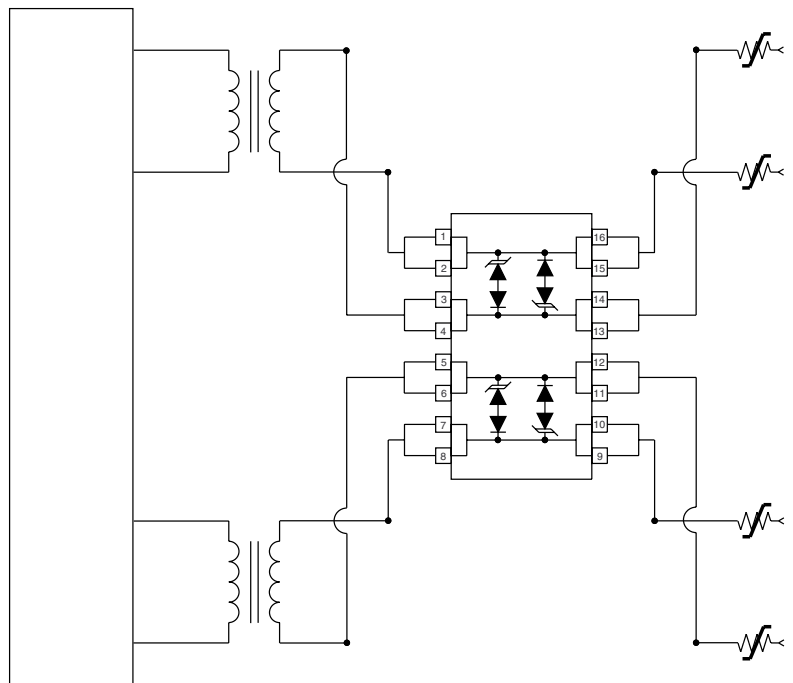
- ✓ Line 1 is connected to Pins 1, 2, 15 & 16.
- ✓ Line 2 is connected to Pins 3, 4, 13 & 14.
- ✓ Line 3 is connected to Pins 5, 6, 11, & 12.
- ✓ Line 4 is connected to Pins 7, 8, 9 & 10.

### **CIRCUIT BOARD LAYOUT RECOMMENDATIONS**

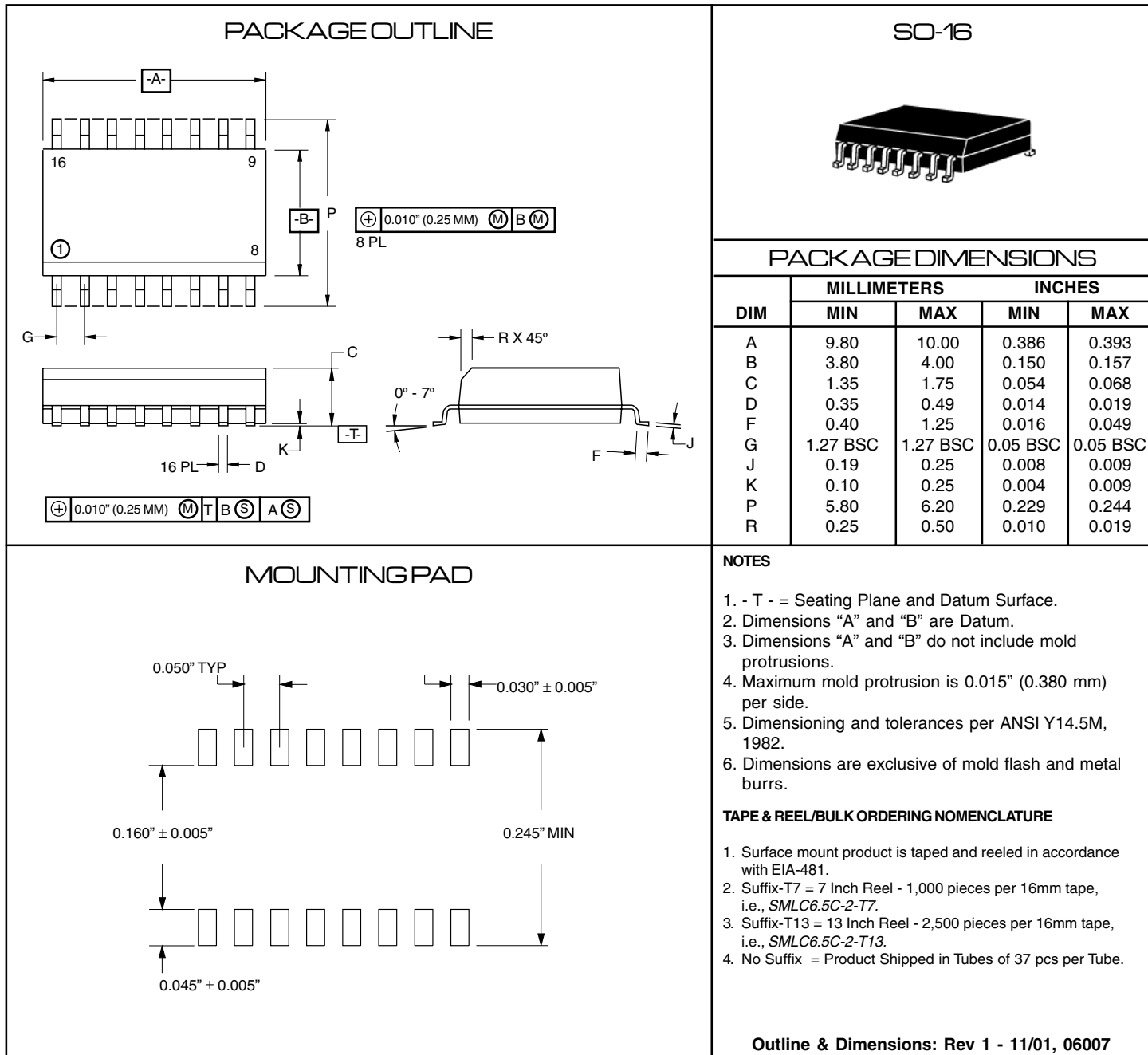
Circuit board layout is critical for Electromagnetic Compatibility (EMC) protection. The following guidelines are recommended:

- ✓ The protection device should be placed near the input terminals or connectors, the device will divert the transient current immediately before it can be coupled into the nearby traces.
- ✓ The path length between the TVS device and the protected line should be minimized.
- ✓ All conductive loops including power and ground loops should be minimized.
- ✓ The transient current return path to ground should be kept as short as possible to reduce parasitic inductance.
- ✓ Ground planes should be used whenever possible. For multilayer PCBs, use ground vias.

Figure 1. Differential-Mode Protection For T1/E1 Applications



## PACKAGE OUTLINE & DIMENSIONS



**COPYRIGHT © ProTek Devices 2003**

SPECIFICATIONS: ProTek reserves the right to change the electrical and or mechanical characteristics described herein without notice (except JEDEC).

DESIGN CHANGES: ProTek reserves the right to discontinue product lines without notice, and that the final judgement concerning selection and specifications is the buyer's and that in furnishing engineering and technical assistance, ProTek assumes no responsibility with respect to the selection or specifications of such products.

**ProTek Devices**  
 2929 South Fair Lane, Tempe, AZ 85282  
 Tel: 602-431-8101 Fax: 602-431-2288  
 E-Mail: [sales@protekdevices.com](mailto:sales@protekdevices.com)  
 Web Site: [www.protekdevices.com](http://www.protekdevices.com)