

Powerex, Inc., 200 Hillis Street, Youngwood, Pennsylvania 15697-1800 (412) 925-7272
 Powerex, Europe, S.A. 428 Avenue G. Durand, BP107, 72003 Le Mans, France (43) 41.14.14

Fast Recovery Rectifier 400 Amperes Average 1600 Volts

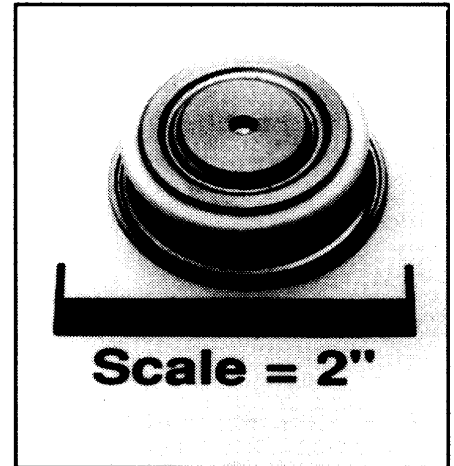
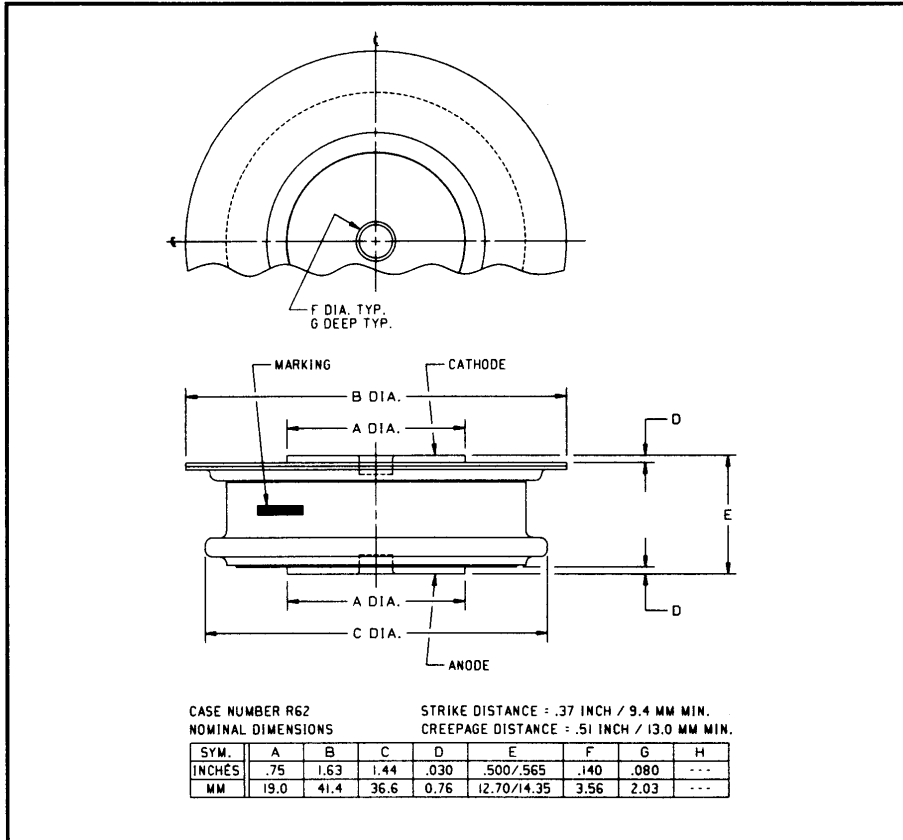

R622_40
 Fast Recovery Rectifier
 400 Amperes Average, 1600 Volts

R622_40 (Outline Drawing)

Features:

- Fast Recovery Times
- Soft Recovery Characteristics
- High Surge Current Ratings
- High Rated Blocking Voltages
- Special Electrical Selection for Parallel and Series Operation
- Single or Double-sided Cooling
- Long Creepage and Strike Paths
- Hermetic Seal
- Special Selection of Recovery Characteristics Available

Applications:

- Inverters
- Choppers
- Transmitters
- Free Wheeling Diode

Ordering Information:

Select the complete part number you desire from the following table:

Type	Voltage		Current		Recovery Time		Leads	
	V_{RRM} (Volts)	Code	$I_{F(av)}$ (A)	Code	t_{rr} (μ sec)	Code	Case	Code
R622	400	04	400	40	1.0	HS	R62	OO
	600	06						
	800	08						
	1000	10						
	1200	12						
	1400	14						
	1600	16						

Example: Type R622 rated at 400A average with $V_{RRM} = 1600V$,
 Recovery Tme = 1.0 μ sec, order as:

Type	Voltage		Current		Time	Leads	
R	6	2	2	1	6	4	0
						HS	O O



Powerex, Inc., 200 Hillis Street, Youngwood, Pennsylvania 15697-1800 (412) 925-7272
 Powerex, Europe, S.A. 428 Avenue G. Durand, BP107, 72003 Le Mans, France (43) 41.14.14

R622_40
Fast Recovery Rectifier
 400 Amperes Average, 1600 Volts

Absolute Maximum Ratings

Characteristics	Symbol	R622_40	Units
RMS Forward Current	$I_{F(rms)}$	625	Amperes
Average Forward Current	$I_{F(av)}$	400	Amperes
One-half Cycle Surge Current	I_{FSM}	4500	Amperes
I^2t (for Fusing), Times = 8.3 milliseconds	I^2t	85000	A^2sec
Max. I^2t of Package (for Times = 8.3 milliseconds)	I^2t	20×10^6	A^2sec
Storage Temperature	T_{stg}	40 to +190	$^{\circ}C$
Operating Temperature	T_j	40 to +150	$^{\circ}C$
Mounting Force		1000 to 1400	lbs

Electrical and Thermal Characteristics

Characteristics	Symbol	Test Conditions	R622_40	Units
Current - Conducting State Maximums				
Forward Voltage Drop	V_{FM}	$T_j = 25^{\circ}C, I_{FM} = 800A$	2.0	Volts
Voltage - Blocking State Maximums				
Repetitive Peak Reverse Voltage (Rated Limit)	V_{RRM}		1600	Volts
Non-rep. Trans. Peak Rev. Voltage (Rated Limit)	V_{RSM}	$t \leq 5.0msec$	1800	Volts
Reverse Leakage Current, mA peak	I_{RRM}	T_j at max., $V_{RRM} = \text{Rated}$	50	mA
Switching				
Maximum Reverse Recovery Time	t_{rr}	$I_{FM} = 785A, t_p = 100\mu sec,$ $di_F/dt = 25A/\mu sec, T_C = 25^{\circ}C$	1.0	μsec
Thermal				
Maximum Resistance, Junction to Case	$R_{\theta(j-c)}$		0.095	$^{\circ}C/Watt$
Maximum Resistance, Case to Sink (Lubricated)	$R_{\theta(c-s)}$		0.025	$^{\circ}C/Watt$

Powerex, Inc., 200 Hillis Street, Youngwood, Pennsylvania 15697-1800 (412) 925-7272
 Powerex, Europe, S.A. 428 Avenue G. Durand, BP107, 72003 Le Mans, France (43) 41.14.14

R622_40
Fast Recovery Rectifier
 400 Amperes Average, 1600 Volts

Reverse Recovery Wave Form

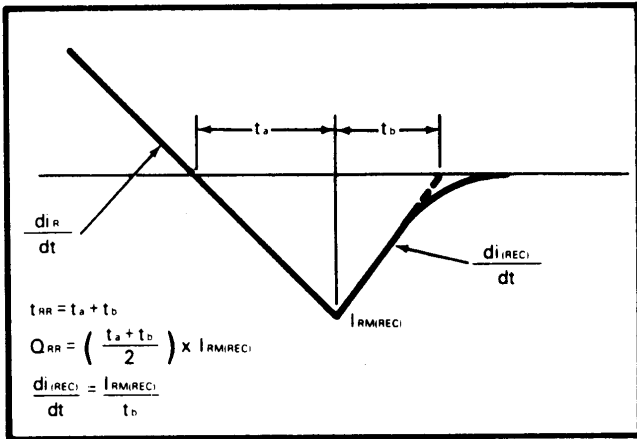

Typical Reverse Recovery Time Vs. Rate of Current Fall

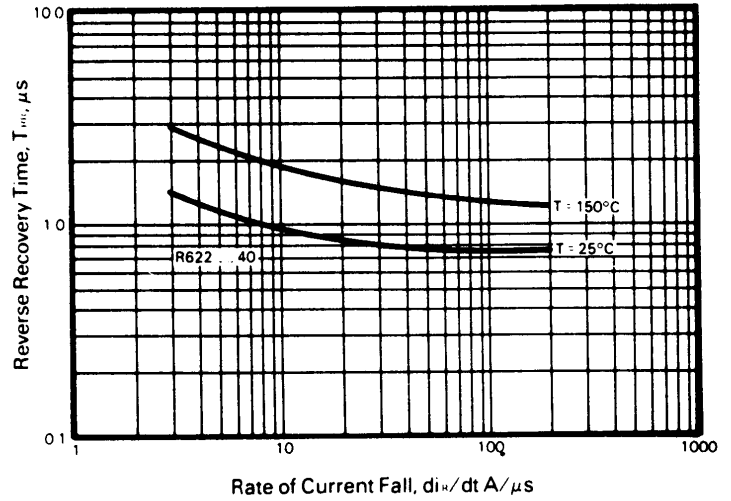

Typical Reverse Recovery Charge Vs. Rate of Current Fall

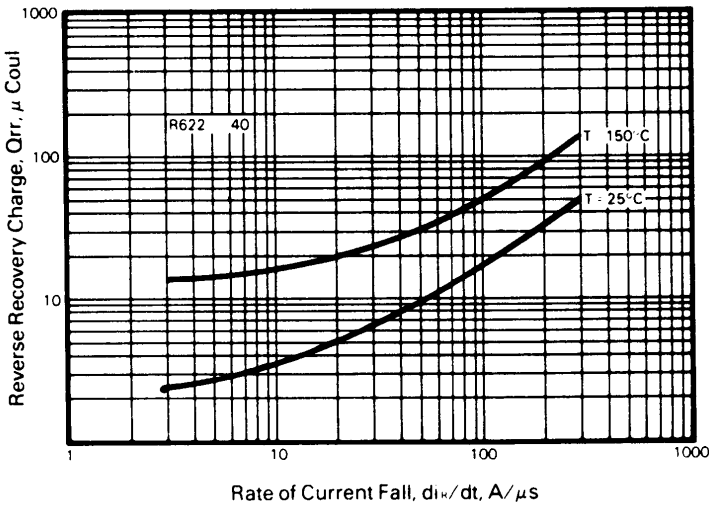

Typical Ratio of Current Recovery to Rate of Current Fall

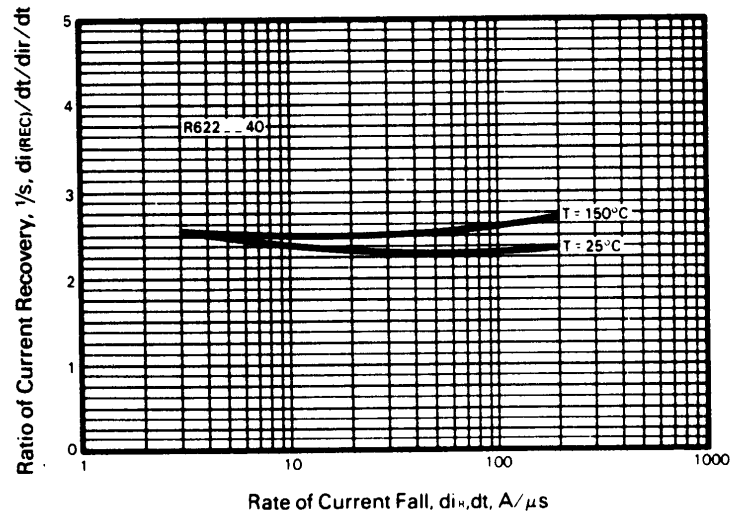

Powerex, Inc., 200 Hillis Street, Youngwood, Pennsylvania 15697-1800 (412) 925-7272
 Powerex, Europe, S.A. 428 Avenue G. Durand, BP107, 72003 Le Mans, France (43) 41.14.14

R622_40
Fast Recovery Rectifier
 400 Amperes Average, 1600 Volts

Forward Current Vs. Forward Voltage Drop

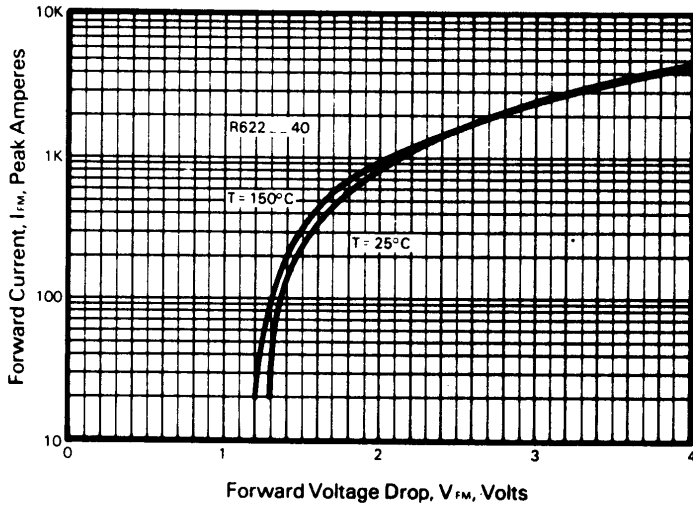

Transient Thermal Impedance Vs. Time

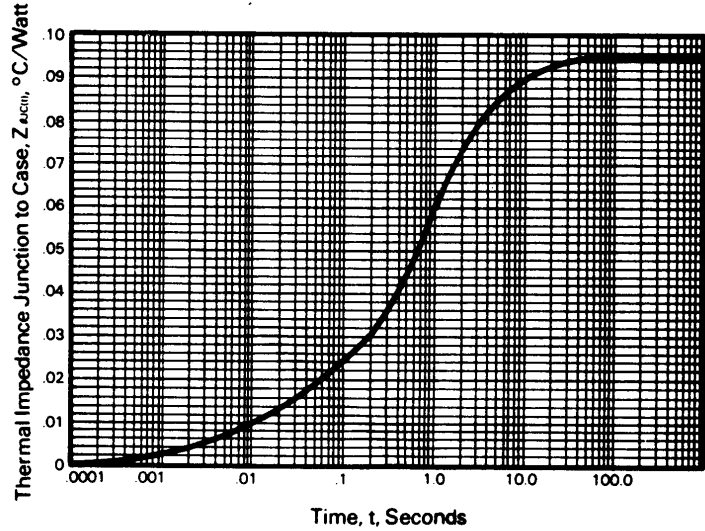

Energy Loss Per Pulse for Sinusoidal Pulses

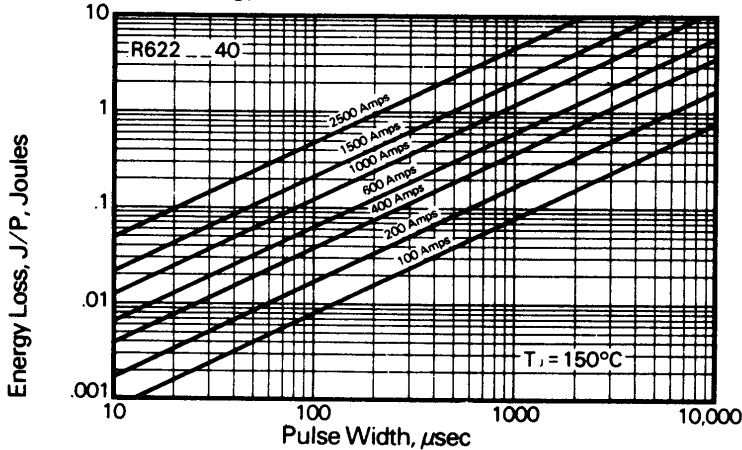

Calculation of Fast Recovery Diodes and Allowable Case Temperature

1. Conduction Losses

$$P_{av(cond)} = J/P \times F$$

2. Reverse Recovery Losses (Approximate)

$$P_{av(sw)} = 1/4 \times V_R \times \frac{di_R}{dt} \times T_{rr}^2 \times \left(\frac{1/s}{1 + 1/s} \right)^2 \times F \times 1 \times 10^{-6}$$

3. Maximum Allowable Case Temperature

$$T_{C(max)} = T_j - (P_{av(cond)} + P_{av(sw)}) \times R_{\theta(j-c)}$$

Where:

$P_{av(cond)}$ = Forward Conduction Power Loss in Watts

$P_{av(sw)}$ = Reverse Recovery Power Loss in Watts

J/P = Energy Loss per Pulse in Joules

F = Frequency in Hertz

V_R = Steady State Reverse Operating Voltage in Volts

di_R/dt = Rate of Decay of Forward Current in Amperes/ μ sec

T_{rr} = Reverse Recovery Time in Microseconds

$\frac{1}{5^{1/2}}$ = Ratio of Recovery di/dt $\left(\frac{di_F/dt}{di_R/dt} \right)$

F = Operating Frequency in Hertz

$T_{C(max)}$ = Maximum Allowable Case Temperature in °C.

T_j = Maximum Operating Junction Temperature in °C.

$R_{\theta(j-c)}$ = DC Junction to Case Thermal Impedance in °C/Watt.