

Trench Gate Design Dual IGBTMOD™ 350 Amperes/250 Volts

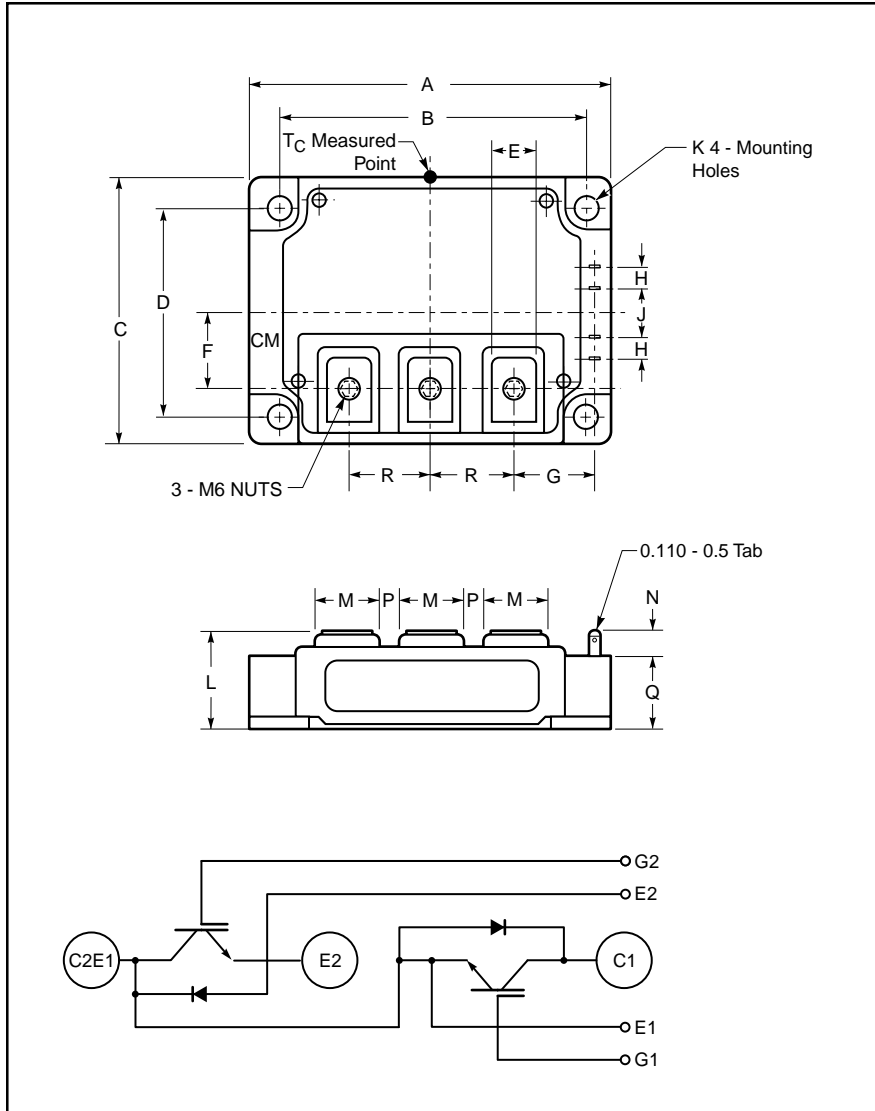

Outline Drawing and Circuit Diagram

Dimensions	Inches	Millimeters
A	4.33	110.0
B	3.66±0.01	93.0±0.25
C	3.15	80.0
D	2.44±0.01	62.0±0.25
E	0.55	14.0
F	0.86	21.75
G	0.94	24.0
H	0.24	6.0

Dimensions	Inches	Millimeters
J	0.59	15.0
K	0.26 Dia.	6.5 Dia.
L	1.14 +0.04/-0.02	29 +1.0/-0.5
M	0.71	18.0
N	0.33	8.5
P	0.28	7.0
Q	0.83	21.0
R	0.98	25.0



Description:

Powerex IGBTMOD™ Modules are designed for use in switching applications. Each module consists of two IGBT Transistors in a half-bridge configuration with each transistor having a reverse-connected super-fast recovery free-wheel diode. All components and interconnects are isolated from the heat sinking baseplate, offering simplified system assembly and thermal management.

Features:

- Low Drive Power
- Low $V_{CE(sat)}$
- Discrete Super-Fast Recovery Free-Wheel Diode
- High Frequency Operation (15-20kHz)
- Isolated Baseplate for Easy Heat Sinking

Applications:

- DC Motor Control
- Boost Regulator

Ordering Information:

Example: Select the complete module number you desire from the table - i.e. CM350DU-5F is a 250V (V_{CES}), 350 Ampere Trench Gate Design Dual IGBTMOD™ Power Module.

Type	Current Rating Amperes	V_{CES} Volts (x 50)
CM	350	5

CM350DU-5F
Trench Gate Design Dual IGBTMOD™
 350 Amperes/250 Volts

Absolute Maximum Ratings, $T_j = 25\text{ }^\circ\text{C}$ unless otherwise specified

Ratings	Symbol	CM350DU-5F	Units
Junction Temperature	T_j	-40 to 150	$^\circ\text{C}$
Storage Temperature	T_{stg}	-40 to 125	$^\circ\text{C}$
Collector-Emitter Voltage (G-E SHORT)	V_{CES}	250	Volts
Gate-Emitter Voltage (C-E SHORT)	V_{GES}	± 20	Volts
Collector Current ($T_c = 25^\circ\text{C}$)	I_C	350	Amperes
Peak Collector Current ($T_j \leq 150^\circ\text{C}$)	I_{CM}	700	Amperes
Emitter Current** ($T_c = 25^\circ\text{C}$)	I_E	350	Amperes
Peak Emitter Current**	I_{EM}	700*	Amperes
Maximum Collector Dissipation ($T_c = 25^\circ\text{C}$)	P_C	960	Watts
Mounting Torque, M6 Main Terminal	–	26	in-lb
Mounting Torque, M6 Mounting	–	26	in-lb
Weight	–	520	Grams
Isolation Voltage (Main Terminal to Baseplate, AC 1 min.)	V_{iso}	2500	Volts

* Pulse width and repetition rate should be such that the device junction temperature (T_j) does not exceed $T_{j(max)}$ rating.

**Represents characteristics of the anti-parallel, emitter-to-collector free-wheel diode (FWDi).

Static Electrical Characteristics, $T_j = 25\text{ }^\circ\text{C}$ unless otherwise specified

Characteristics	Symbol	Test Conditions	Min.	Typ.	Max.	Units
Collector-Cutoff Current	I_{CES}	$V_{CE} = V_{CES}, V_{GE} = 0V$	–	–	1	mA
Gate Leakage Current	I_{GES}	$V_{GE} = V_{CES}, V_{CE} = 0V$	–	–	0.5	μA
Gate-Emitter Threshold Voltage	$V_{GE(th)}$	$I_C = 35\text{mA}, V_{CE} = 10V$	3.0	4.0	5.0	Volts
Collector-Emitter Saturation Voltage	$V_{CE(sat)}$	$I_C = 350\text{A}, V_{GE} = 10V, T_j = 25^\circ\text{C}$	–	1.2	1.7	Volts
		$I_C = 350\text{A}, V_{GE} = 10V, T_j = 125^\circ\text{C}$	–	1.10	–	Volts
Total Gate Charge	Q_G	$V_{CC} = 100V, I_C = 350\text{A}, V_{GE} = 10V$	–	1320	–	nC
Emitter-Collector Voltage*	V_{EC}	$I_E = 350\text{A}, V_{GE} = 0V$	–	–	2.0	Volts

* Pulse width and repetition rate should be such that the device junction temperature (T_j) does not exceed $T_{j(max)}$ rating.

Dynamic Electrical Characteristics, $T_j = 25\text{ }^\circ\text{C}$ unless otherwise specified

Characteristics	Symbol	Test Conditions	Min.	Typ.	Max.	Units	
Input Capacitance	C_{ies}		–	–	99	nf	
Output Capacitance	C_{oes}	$V_{CE} = 10V, V_{GE} = 0V$	–	–	4.5	nf	
Reverse Transfer Capacitance	C_{res}		–	–	3.4	nf	
Resistive	Turn-on Delay Time	$t_{d(on)}$	$V_{CC} = 100V, I_C = 350\text{A},$	–	–	1100	ns
Load	Rise Time	t_r	$V_{GE1} = V_{GE2} = 10V,$	–	–	2400	ns
Switch	Turn-off Delay Time	$t_{d(off)}$	$R_G = 7.1\text{ }\Omega$, Resistive	–	–	900	ns
Times	Fall Time	t_f	Load Switching Operation	–	–	500	ns
Diode Reverse Recovery Time	t_{rr}	$I_E = 350\text{A}, di_E/dt = -700\text{A/ms}$	–	–	300	ns	
Diode Reverse Recovery Charge	Q_{rr}	$I_E = 350\text{A}, di_E/dt = -700\text{A/ms}$	–	5.7	–	μC	

Thermal and Mechanical Characteristics, $T_j = 25\text{ }^\circ\text{C}$ unless otherwise specified

Characteristics	Symbol	Test Conditions	Min.	Typ.	Max.	Units
Thermal Resistance, Junction to Case	$R_{th(j-c)}$	Per IGBT	–	–	0.13	$^\circ\text{C/W}$
Thermal Resistance, Junction to Case	$R_{th(j-c)}$	Per Free-Wheel Diode	–	–	0.19	$^\circ\text{C/W}$
Contact Thermal Resistance	$R_{th(c-f)}$	Per Module, Thermal Grease Applied	–	0.010	–	$^\circ\text{C/W}$

CM350DU-5F
Trench Gate Design Dual IGBTMOD™
 350 Amperes/250 Volts

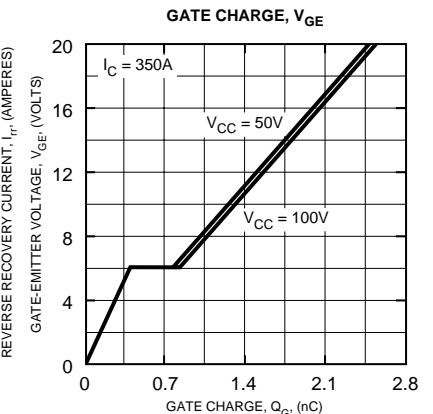
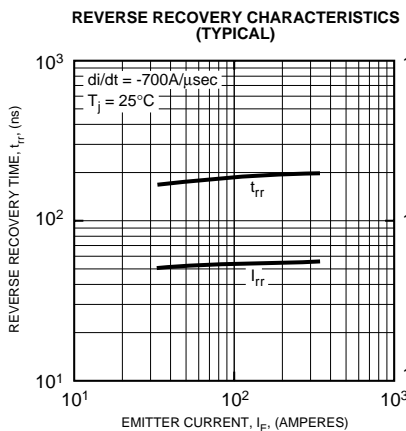
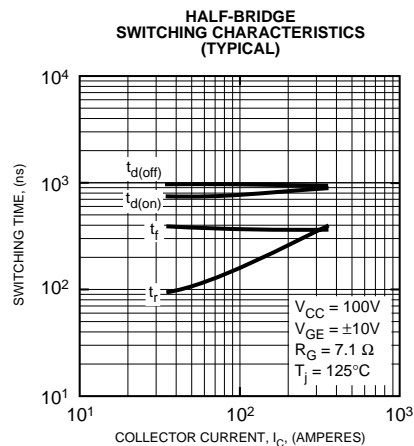
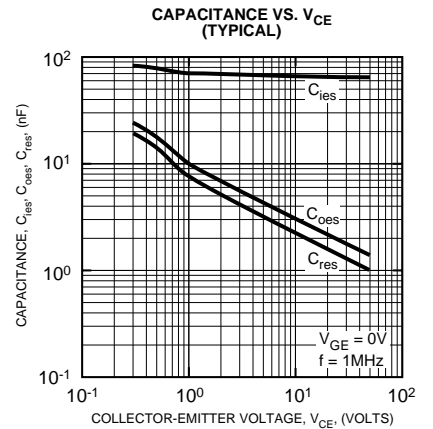
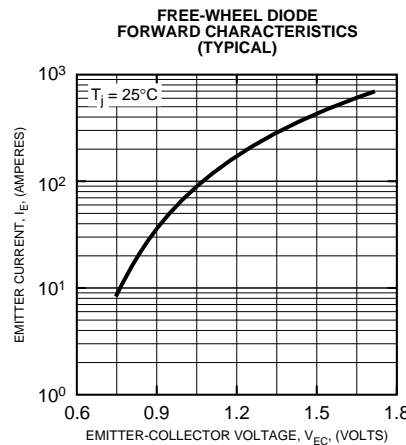
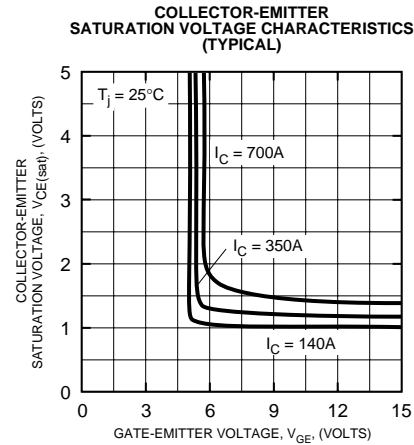
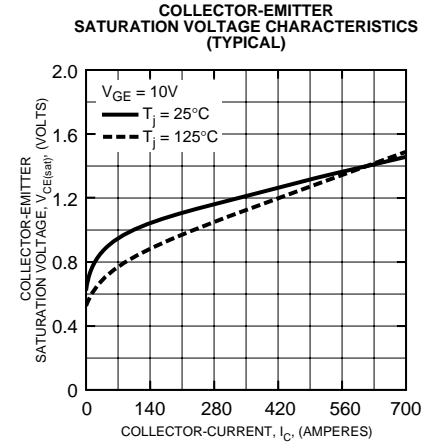
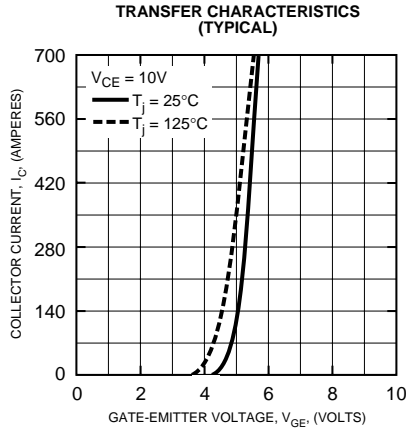
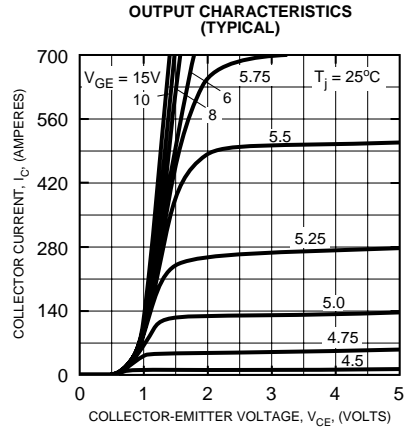

CM350DU-5F
Trench Gate Design Dual IGBTMOD™
 350 Amperes/250 Volts

