

Intellimod™ Module Single Phase IGBT Inverter Output 150 Amperes/1200 Volts

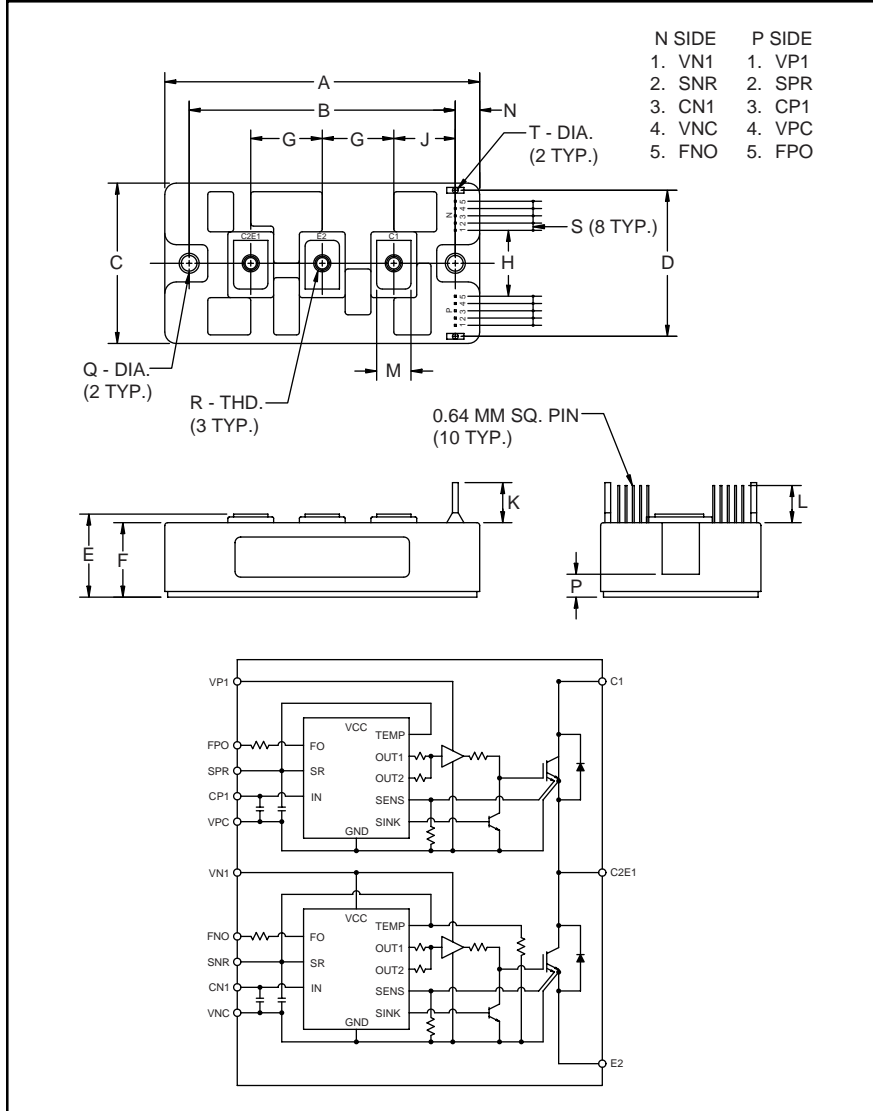

Outline Drawing and Circuit Diagram

Dimensions	Inches	Millimeters
A	4.33	110.0
B	3.66±0.010	93.0±0.25
C	2.20	56.0
D	2.01	51.0
E	1.14 +0.04/-0.02	29.0 +1/-0.5
F	1.02	26.0
G	0.98	25.0
H	0.90	23.0
J	0.85	21.5

Dimensions	Inches	Millimeters
K	0.55	14.0
L	0.51	13.0
M	0.47	12.0
N	0.33	8.5
P	0.28	7.0
Q	0.22 Dia.	Dia. 5.5
R	M5 Metric	M5
S	0.100	2.54
T	0.08 Dia.	Dia. 2.0



Description:

Powerex Intellimod™ Intelligent Power Modules are isolated base modules designed for power switching applications operating at frequencies to 20kHz. Built-in control circuits provide optimum gate drive and protection for the IGBT and free wheel diode power devices.

Features:

- Complete Output Power Circuit
- Gate Drive Circuit
- Protection Logic
 - Short Circuit
 - Over Current
 - Over Temperature
 - Under Voltage

Applications:

- Inverters
- UPS
- Motion/Servo Control
- Power Supplies

Ordering Information:

Example: Select the complete part number from the table below -i.e. PM150DSA120 is a 1200V, 150 Ampere Intellimod™ Intelligent Power Module.

Type	Current Rating Amperes	V _{CE} Volts (x 10)
PM	150	120



Powerex, Inc., 200 Hillis Street, Youngwood, Pennsylvania 15697-1800 (724) 925-7272

PM150DSA120
Intellimod™ Module
Single Phase IGBT Inverter Output
 150 Amperes/1200 Volts

Absolute Maximum Ratings, $T_j = 25^\circ\text{C}$ unless otherwise specified

Characteristics	Symbol	PM150DSA120	Units
Power Device Junction Temperature	T_j	-20 to 150	$^\circ\text{C}$
Storage Temperature	T_{stg}	-40 to 125	$^\circ\text{C}$
Case Operating Temperature	T_C	-20 to 100	$^\circ\text{C}$
Mounting Torque, M5 Mounting Screws	—	17	in-lb
Mounting Torque, M5 Main Terminal Screws	—	17	in-lb
Module Weight (Typical)	—	430	Grams
Supply Voltage Protected by OC and SC ($V_D = 13.5 - 16.5\text{V}$, Inverter Part)	$V_{\text{CC(prot.)}}$	800	Volts
Isolation Voltage, AC 1 minute, 60Hz Sinusoidal	V_{RMS}	2500	Volts

Control Sector

Supply Voltage Applied between ($V_{P1}-V_{PC}$, $V_{N1}-V_{NC}$)	V_D	20	Volts
Input Voltage Applied between ($C_{P1}-V_{PC}$, $C_{N1}-V_{NC}$)	V_{CIN}	20	Volts
Fault Output Supply Voltage (Applied between $F_{po}-V_{pc}$ and $F_{no}-V_{nc}$)	V_{FO}	20	Volts
Fault Output Current	I_{FO}	20	mA

IGBT Inverter Sector

Collector-Emitter Voltage ($V_D = 15\text{V}$, $V_{\text{CIN}} = 5\text{V}$)	V_{CES}	1200	Volts
Collector Current, \pm	I_C	150	Amperes
Peak Collector Current, \pm	I_{CP}	300	Amperes
Supply Voltage (Applied between C1 - E2)	V_{CC}	900	Volts
Supply Voltage, Surge (Applied between C1 - E2)	$V_{\text{CC(surge)}}$	1000	Volts
Collector Dissipation	P_C	960	Watts

PM150DSA120
Intellimod™ Module
Single Phase IGBT Inverter Output
 150 Amperes/1200 Volts

Electrical and Mechanical Characteristics, $T_j = 25^\circ\text{C}$ unless otherwise specified

Characteristics	Symbol	Test Conditions	Min.	Typ.	Max.	Units
Control Sector						
Over Current Trip Level Inverter Part	OC	$-20^\circ\text{C} \leq T \leq 125^\circ\text{C}$	200	320	—	Amperes
Short Circuit Trip Level Inverter Part	SC	$-20^\circ\text{C} \leq T \leq 125^\circ\text{C}$	280	450	—	Amperes
Over Current Delay Time	$t_{\text{off}}(\text{OC})$	$V_D = 15\text{V}$	—	5	—	μS
Over Temperature Protection	OT	Trip Level	100	110	120	$^\circ\text{C}$
	OT _R	Reset Level	85	95	105	$^\circ\text{C}$
Supply Circuit Under Voltage Protection	UV	Trip Level	11.5	12.0	12.5	Volts
	UV _R	Reset Level	—	12.5	—	Volts
Supply Voltage	V_D	Applied between $V_{P1}-V_{PC}$, $V_{N1}-V_{NC}$	13.5	15	16.5	Volts
Circuit Current	I_D	$V_D = 15\text{V}$, $V_{\text{CIN}} = 5\text{V}$, $V_{N1}-V_{NC}$	—	19	26	mA
		$V_D = 15\text{V}$, $V_{\text{CIN}} = 5\text{V}$, $V_{\text{XP1}}-V_{\text{XPC}}$	—	19	26	mA
Input ON Threshold Voltage	$V_{\text{CIN}}(\text{on})$	Applied between	1.2	1.5	1.8	Volts
Input OFF Threshold Voltage	$V_{\text{CIN}}(\text{off})$	$C_{P1}-V_{PC}$, $C_{N1}-V_{NC}$	1.7	2.0	2.3	Volts
PWM Input Frequency	f_{PWM}	3- \emptyset Sinusoidal	—	15	20	kHz
Fault Output Current	$I_{\text{FO}}(\text{H})$	$V_D = 15\text{V}$, $V_{\text{FO}} = 15\text{V}$	—	—	0.01	mA
	$I_{\text{FO}}(\text{L})$	$V_D = 15\text{V}$, $V_{\text{FO}} = 15\text{V}$	—	10	15	mA
Minimum Fault Output Pulse Width	t_{FO}	$V_D = 15\text{V}$	1.0	1.8	—	mS
SXR Terminal Output Voltage	V_{SXR}	$T_j \leq 125^\circ\text{C}$, $R_{\text{in}} = 6.8 \text{ k}\Omega$ (S_{PR} , S_{NR})	4.5	5.1	5.6	Volts

PM150DSA120
Intellimod™ Module
Single Phase IGBT Inverter Output
150 Amperes/1200 Volts

Electrical and Mechanical Characteristics, $T_j = 25^\circ\text{C}$ unless otherwise specified

Characteristics	Symbol	Test Conditions	Min.	Typ.	Max.	Units
IGBT Inverter Sector						
Collector Cutoff Current	I_{CEX}	$V_{CE} = V_{CEX}, T_j = 25^\circ\text{C}$	—	—	1	mA
		$V_{CE} = V_{CEX}, T_j = 125^\circ\text{C}$	—	—	10	mA
Diode Forward Voltage	V_{FM}	$-I_C = 150\text{A}, V_D = 15\text{V}, V_{CIN} = 5\text{V}$	—	2.5	3.5	Volts
Collector-Emitter Saturation Voltage	$V_{CE(sat)}$	$V_D = 15\text{V}, V_{CIN} = 0\text{V}, I_C = 150\text{A}$	—	2.3	3.2	Volts
		$V_D = 15\text{V}, V_{CIN} = 0\text{V}, I_C = 150\text{A}, T_j = 125^\circ\text{C}$	—	2.1	2.9	Volts
Inductive Load Switching Times	t_{on}		0.5	1.4	2.5	μS
	t_{rr}	$V_D = 15\text{V}, V_{CIN} = 0 \sim 5\text{V}$	—	0.2	0.4	μS
	$t_{C(on)}$	$V_{CC} = 600\text{V}, I_C = 150\text{A}$	—	0.4	1.0	μS
	t_{off}	$T_j = 125^\circ\text{C}$	—	2.5	3.5	μS
	$t_{C(off)}$		—	0.6	1.1	μS

Thermal Characteristics

Characteristic	Symbol	Condition	Min.	Typ.	Max.	Units
Junction to Case Thermal Resistance	$R_{th(j-c)Q}$	Each IGBT	—	—	0.13	$^\circ\text{C/Watt}$
	$R_{th(j-c)D}$	Each FWDi	—	—	0.25	$^\circ\text{C/Watt}$
Contact Thermal Resistance	$R_{th(c-f)}$	Case to Fin Per Module Thermal Grease Applied	—	—	0.048	$^\circ\text{C/Watt}$

Recommended Conditions for Use

Characteristic	Symbol	Condition	Value	Units
Supply Voltage	V_{CC}	Applied across C1-E2 Terminals	0 ~ 800	Volts
	V_D	Applied between $V_{P1-V_{PC}}, V_{N1-V_{NC}}$	15 ± 1.5	Volts
Input ON Voltage	$V_{CIN(on)}$	Applied between	0 ~ 0.8	Volts
Input OFF Voltage	$V_{CIN(off)}$	$C_{P1-V_{PC}}, C_{N1-V_{NC}}$	$4.0 \sim V_{SXR}$	Volts
PWM Input Frequency	f_{PWM}	Using Application Circuit	5 ~ 20	kHz
Minimum Dead Time	t_{DEAD}	Input Signal	≥ 3.5	μS



Powerex, Inc., 200 Hillis Street, Youngwood, Pennsylvania 15697-1800 (724) 925-7272

PM150DSA120
Intellimod™ Module
Single Phase IGBT Inverter Output
150 Amperes/1200 Volts

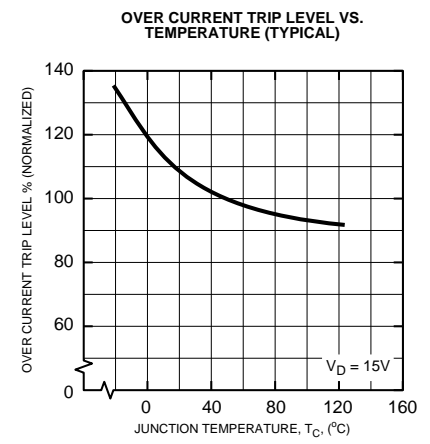
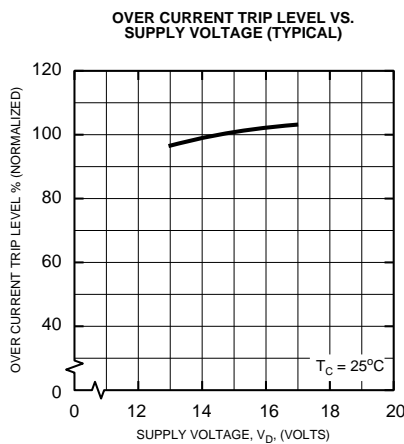
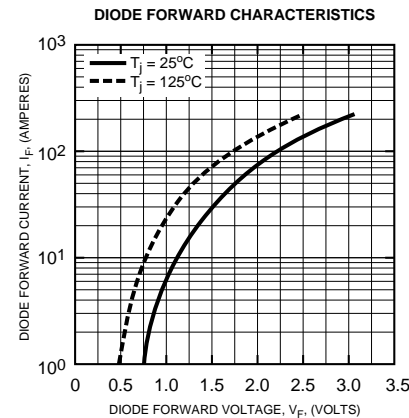
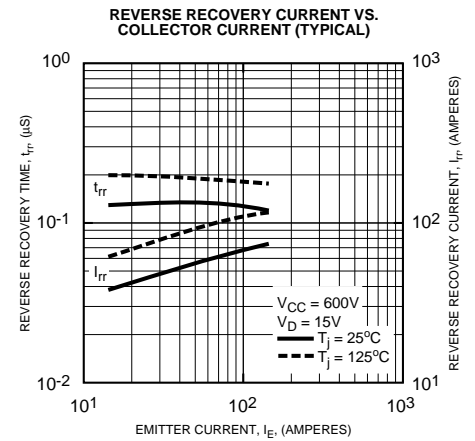
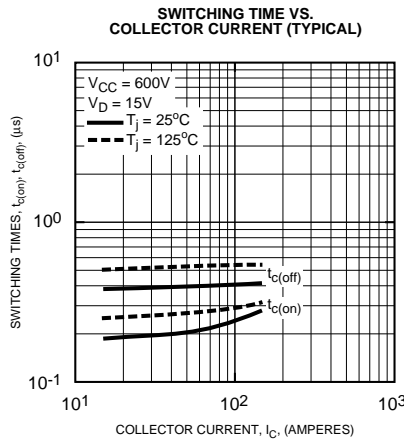
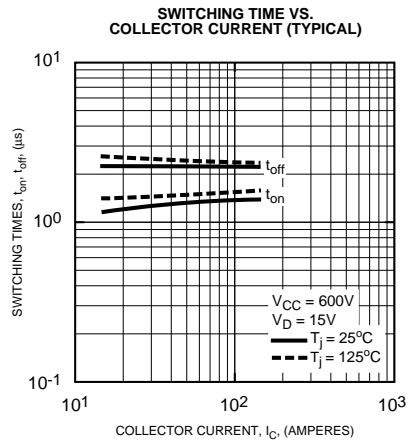
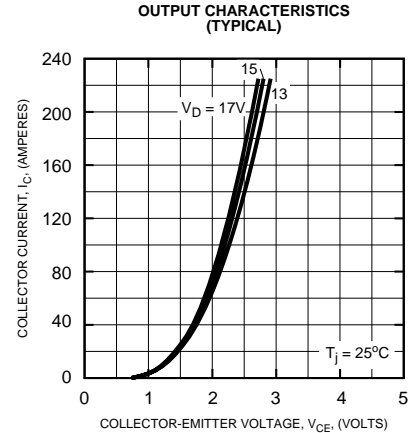
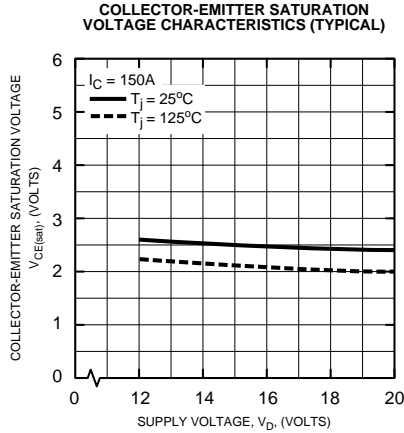
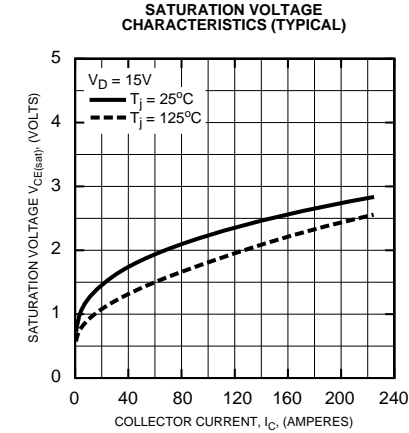

PM150DSA120
Intellimod™ Module
Single Phase IGBT Inverter Output
 150 Amperes/1200 Volts

FAULT OUTPUT PULSE WIDTH VS. TEMPERATURE (TYPICAL)

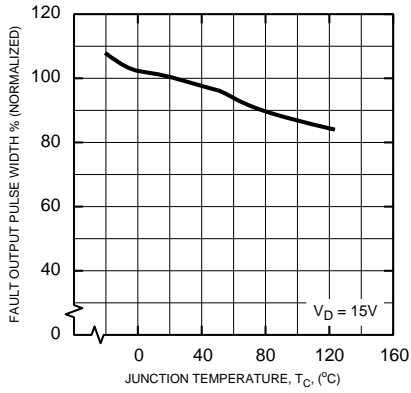

CONTROL SUPPLY VOLTAGE TRIP-RESET LEVEL TEMPERATURE DEPENDENCY (TYPICAL)

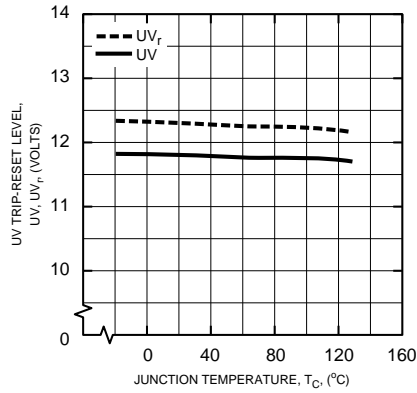

TRANSIENT THERMAL IMPEDANCE CHARACTERISTICS (IGBT)

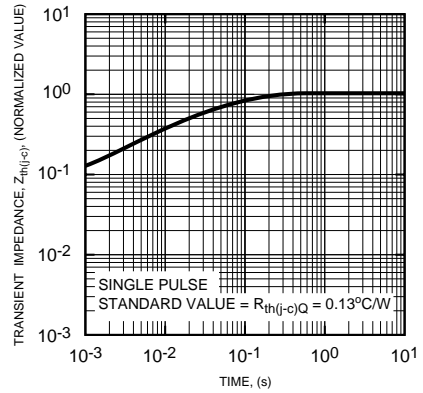

TRANSIENT THERMAL IMPEDANCE CHARACTERISTICS (FWD)

