

FK25SM-6

HIGH-SPEED SWITCHING USE

FK25SM-6

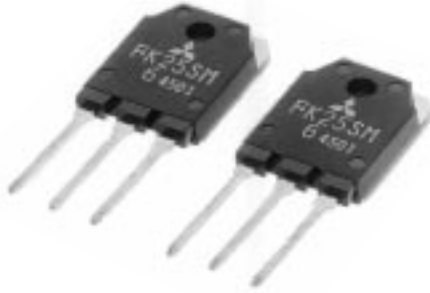

- V_{DSS} 300V
- $r_{DS(ON)}$ (MAX) 0.21Ω
- I_D 25A
- Integrated Fast Recovery Diode (MAX.) 150ns

OUTLINE DRAWING

Dimensions in mm

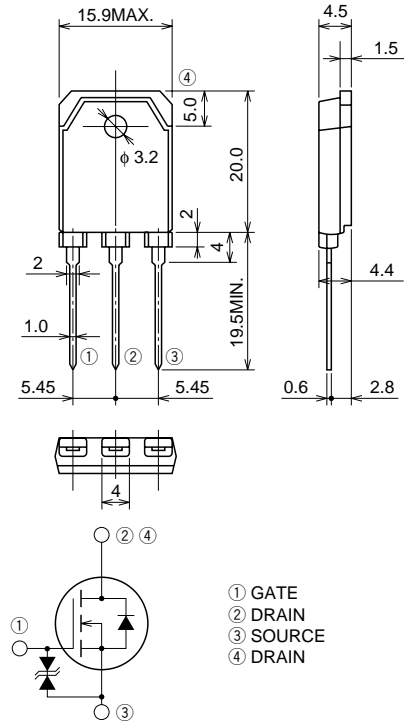

APPLICATION

Servo motor drive, Robot, UPS, Inverter Fluorecent lamp, etc.

MAXIMUM RATINGS (Tc = 25°C)

| Symbol | Parameter | Conditions | Ratings | Unit |
|-----------|---------------------------|---------------|------------|------|
| V_{DSS} | Drain-source voltage | $V_{GS} = 0V$ | 300 | V |
| V_{GSS} | Gate-source voltage | $V_{DS} = 0V$ | ± 30 | V |
| I_D | Drain current | | 25 | A |
| I_{DM} | Drain current (Pulsed) | | 75 | A |
| I_S | Source current | | 25 | A |
| I_{SM} | Source current (Pulsed) | | 75 | A |
| P_D | Maximum power dissipation | | 250 | W |
| T_{ch} | Channel temperature | | -55 ~ +150 | °C |
| T_{stg} | Storage temperature | | -55 ~ +150 | °C |
| — | Weight | Typical value | 4.8 | g |

ELECTRICAL CHARACTERISTICS (T_{ch} = 25°C)

| Symbol | Parameter | Test conditions | Limits | | | Unit |
|------------------------|----------------------------------|---|--------|------|------|------|
| | | | Min. | Typ. | Max. | |
| V (BR) DSS | Drain-source breakdown voltage | I _D = 1mA, V _{GS} = 0V | 300 | — | — | V |
| V (BR) GSS | Gate-source breakdown voltage | I _G = ±100μA, V _{DS} = 0V | ±30 | — | — | V |
| I _{GSS} | Gate-source leakage current | V _{GS} = ±25V, V _{DS} = 0V | — | — | ±10 | μA |
| I _{DSS} | Drain-source leakage current | V _{DS} = 300V, V _{GS} = 0V | — | — | 1 | mA |
| V _{GS} (th) | Gate-source threshold voltage | I _D = 1mA, V _{DS} = 10V | 2 | 3 | 4 | V |
| r _{DS} (ON) | Drain-source on-state resistance | I _D = 12A, V _{GS} = 10V | — | 0.16 | 0.21 | Ω |
| V _{DS} (ON) | Drain-source on-state voltage | I _D = 12A, V _{GS} = 10V | — | 1.92 | 2.52 | V |
| y _{fs} | Forward transfer admittance | I _D = 12A, V _{DS} = 10V | 7.0 | 11.0 | — | S |
| C _{iss} | Input capacitance | V _{DS} = 25V, V _{GS} = 0V, f = 1MHz | — | 2100 | — | pF |
| C _{oss} | Output capacitance | | — | 420 | — | pF |
| C _{rss} | Reverse transfer capacitance | | — | 90 | — | pF |
| t _d (on) | Turn-on delay time | V _{DD} = 150V, I _D = 12A, V _{GS} = 10V, R _{GEN} = R _{GS} = 50Ω | — | 35 | — | ns |
| t _r | Rise time | | — | 85 | — | ns |
| t _d (off) | Turn-off delay time | | — | 240 | — | ns |
| t _f | Fall time | | — | 100 | — | ns |
| V _{SD} | Source-drain voltage | I _S = 12A, V _{GS} = 0V | — | 1.5 | 2.0 | V |
| R _{th} (ch-c) | Thermal resistance | Channel to case | — | — | 0.50 | °C/W |
| t _{rr} | Reverse recovery time | I _S = 25A, di _s /dt = -100A/μs | — | — | 150 | ns |

PERFORMANCE CURVES

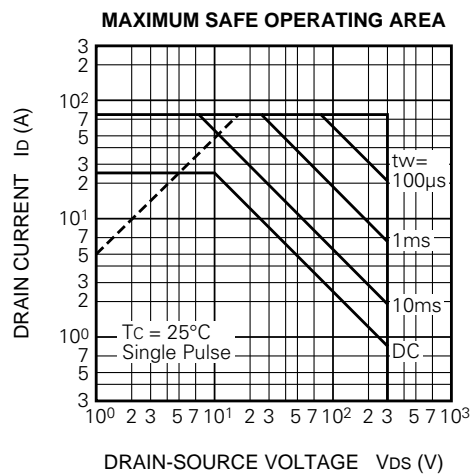
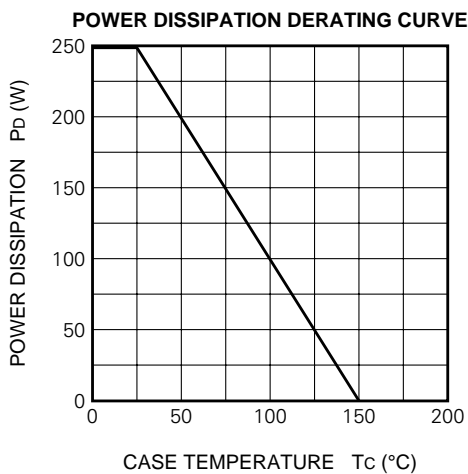

OUTPUT CHARACTERISTICS (TYPICAL)

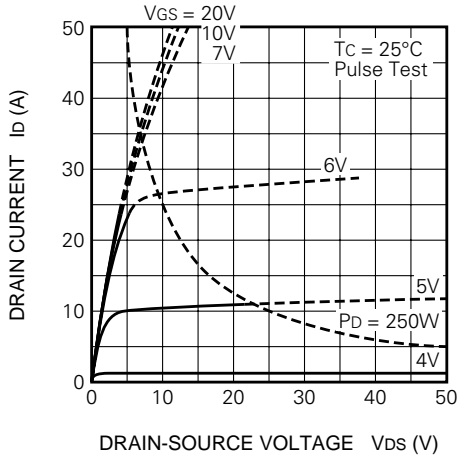

OUTPUT CHARACTERISTICS (TYPICAL)

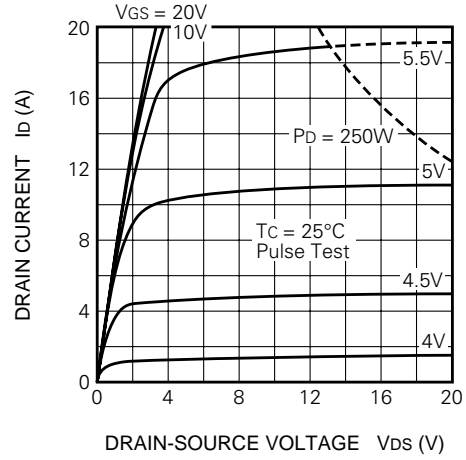

ON-STATE VOLTAGE VS. GATE-SOURCE VOLTAGE (TYPICAL)

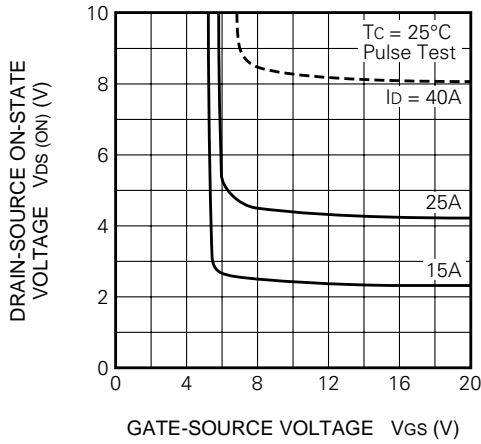

ON-STATE RESISTANCE VS. DRAIN CURRENT (TYPICAL)

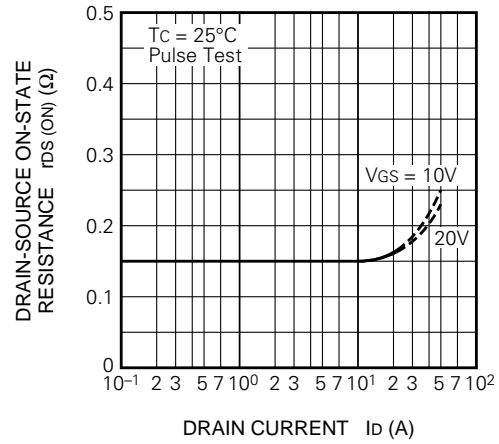

TRANSFER CHARACTERISTICS (TYPICAL)

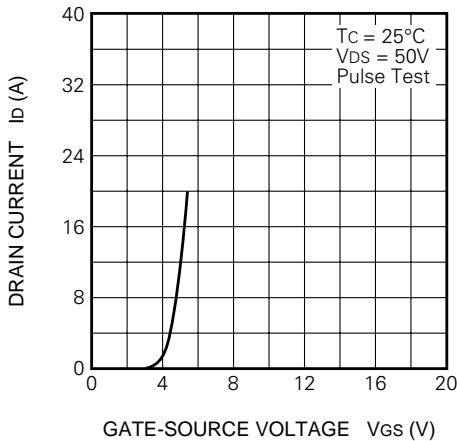

FORWARD TRANSFER ADMITTANCE VS. DRAIN CURRENT (TYPICAL)

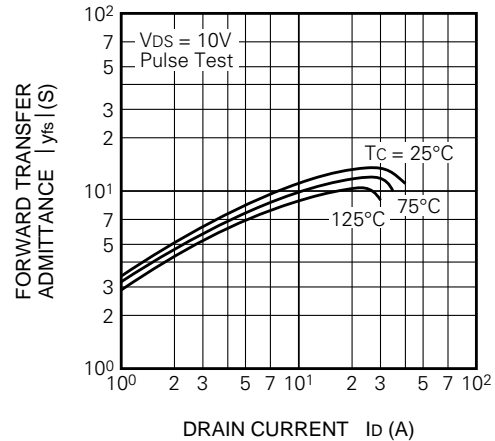

CAPACITANCE VS. DRAIN-SOURCE VOLTAGE (TYPICAL)

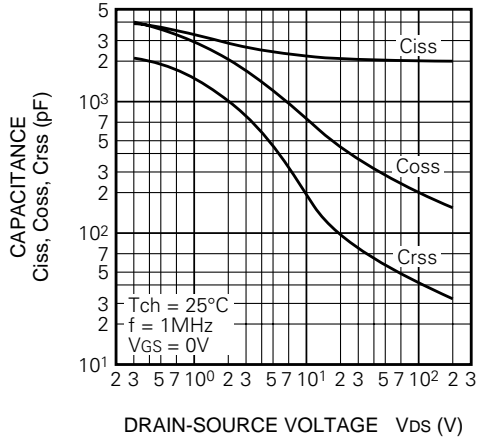

SWITCHING CHARACTERISTICS (TYPICAL)

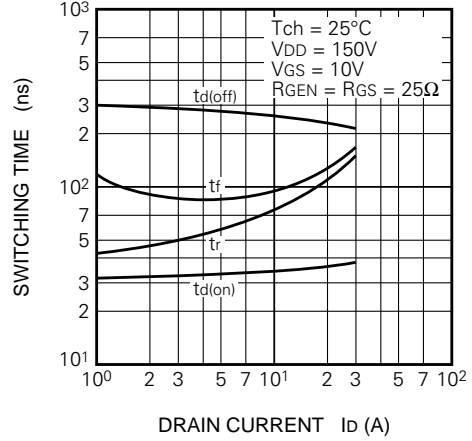

GATE-SOURCE VOLTAGE VS. GATE CHARGE (TYPICAL)

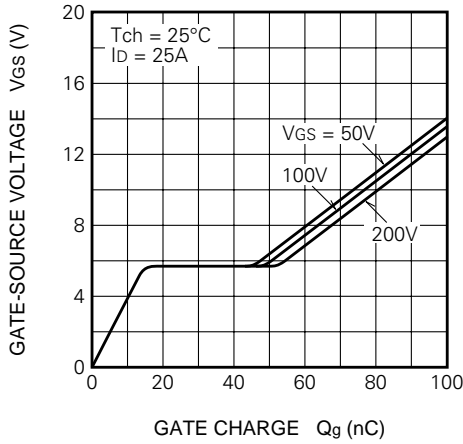

SOURCE-DRAIN DIODE FORWARD CHARACTERISTICS (TYPICAL)

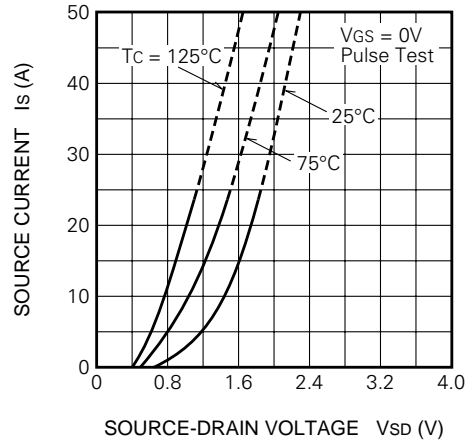

ON-STATE RESISTANCE VS. CHANNEL TEMPERATURE (TYPICAL)

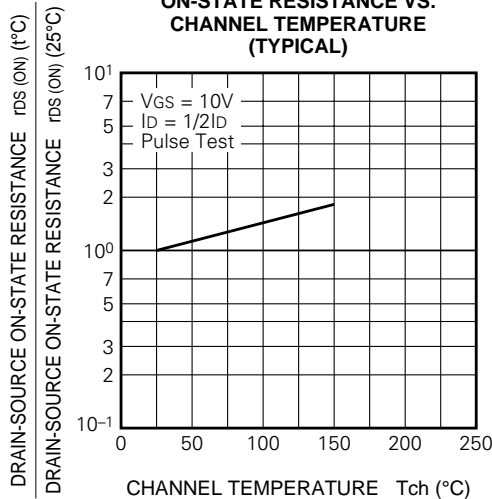

THRESHOLD VOLTAGE VS. CHANNEL TEMPERATURE (TYPICAL)

