

# FS2KMJ-3

HIGH-SPEED SWITCHING USE

## FS2KMJ-3



- 4V DRIVE
- V<sub>DSS</sub> ..... 150V
- r<sub>DS (ON)</sub> (MAX) ..... 0.75Ω
- I<sub>D</sub> ..... 2A
- Integrated Fast Recovery Diode (TYP.) ..... 65ns
- V<sub>iso</sub> ..... 2000V

## OUTLINE DRAWING

Dimensions in mm

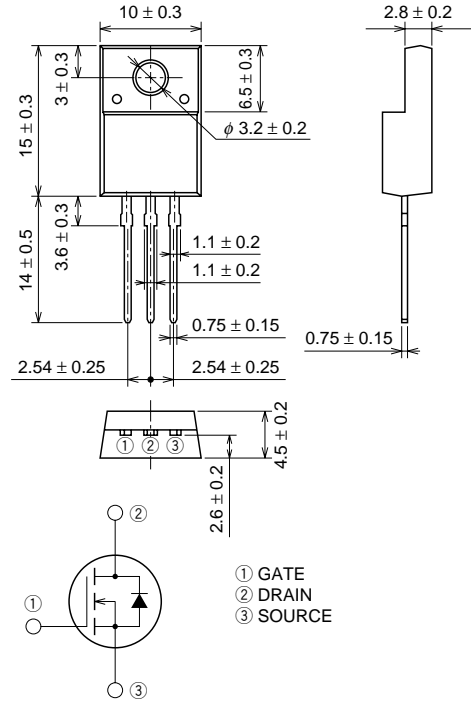

TO-220FN

## APPLICATION

Motor control, Lamp control, Solenoid control  
DC-DC converter, etc.

## MAXIMUM RATINGS (T<sub>c</sub> = 25°C)

Symbol	Parameter	Conditions	Ratings	Unit
V <sub>DSS</sub>	Drain-source voltage	V <sub>GS</sub> = 0V	150	V
V <sub>GSS</sub>	Gate-source voltage	V <sub>DS</sub> = 0V	±20	V
I <sub>D</sub>	Drain current		2	A
I <sub>DM</sub>	Drain current (Pulsed)		8	A
I <sub>DA</sub>	Avalanche drain current (Pulsed)	L = 100μH	2	A
I <sub>S</sub>	Source current		2	A
I <sub>SM</sub>	Source current (Pulsed)		8	A
P <sub>D</sub>	Maximum power dissipation		15	W
T <sub>ch</sub>	Channel temperature		-55 ~ +150	°C
T <sub>stg</sub>	Storage temperature		-55 ~ +150	°C
V <sub>iso</sub>	Isolation voltage	AC for 1minute, Terminal to case	2000	V
—	Weight	Typical value	2.0	g

**ELECTRICAL CHARACTERISTICS** (Tch = 25°C)

Symbol	Parameter	Test conditions	Limits			Unit
			Min.	Typ.	Max.	
V (BR) DSS	Drain-source breakdown voltage	Id = 1mA, Vgs = 0V	150	—	—	V
IgSS	Gate-source leakage current	Vgs = ±20V, Vds = 0V	—	—	±0.1	µA
IbSS	Drain-source leakage current	Vds = 150V, Vgs = 0V	—	—	0.1	mA
VGS (th)	Gate-source threshold voltage	Id = 1mA, Vds = 10V	1.0	1.5	2.0	V
rDS (ON)	Drain-source on-state resistance	Id = 1A, Vgs = 10V	—	0.58	0.75	Ω
rDS (ON)	Drain-source on-state resistance	Id = 1A, Vgs = 4V	—	0.61	0.81	Ω
VDS (ON)	Drain-source on-state voltage	Id = 1A, Vgs = 10V	—	0.58	0.75	V
yfs	Forward transfer admittance	Id = 1A, Vds = 5V	—	4.5	—	S
Ciss	Input capacitance	Vds = 10V, Vgs = 0V, f = 1MHz	—	360	—	pF
Coss	Output capacitance		—	62	—	pF
Crss	Reverse transfer capacitance		—	16	—	pF
td (on)	Turn-on delay time	VDD = 80V, Id = 1A, Vgs = 10V, RGEN = RGS = 50Ω	—	11	—	ns
tr	Rise time		—	9	—	ns
td (off)	Turn-off delay time		—	35	—	ns
tf	Fall time		—	13	—	ns
VSD	Source-drain voltage	Is = 1A, Vgs = 0V	—	1.0	1.5	V
Rth (ch-c)	Thermal resistance	Channel to case	—	—	8.33	°C/W
trr	Reverse recovery time	Is = 2A, dis/dt = -100A/µs	—	65	—	ns

**PERFORMANCE CURVES**

**POWER DISSIPATION DERATING CURVE**

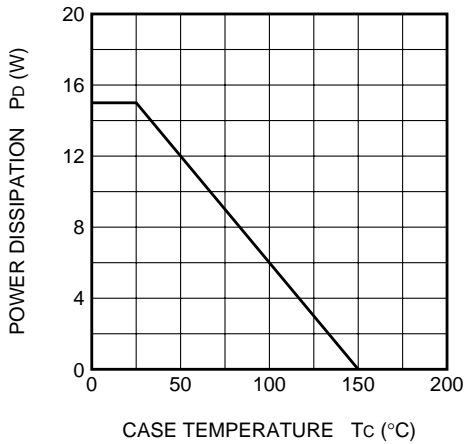

**MAXIMUM SAFE OPERATING AREA**

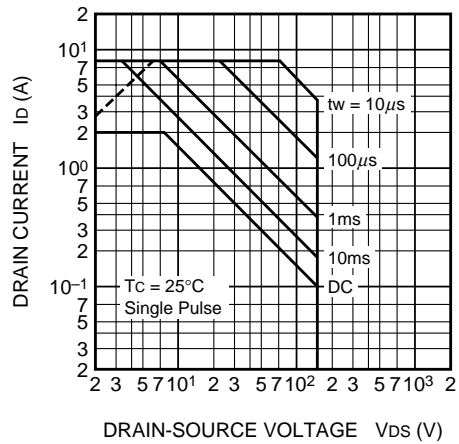

**OUTPUT CHARACTERISTICS (TYPICAL)**

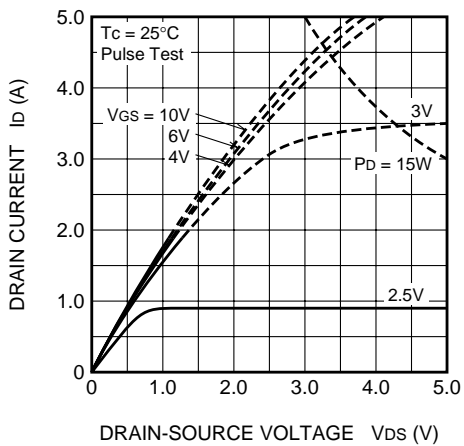

**OUTPUT CHARACTERISTICS (TYPICAL)**

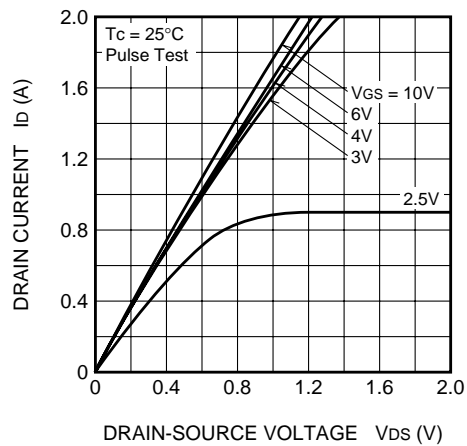

ON-STATE VOLTAGE VS. GATE-SOURCE VOLTAGE (TYPICAL)

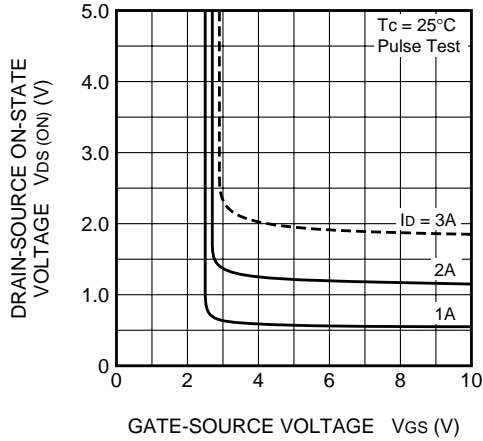

ON-STATE RESISTANCE VS. DRAIN CURRENT (TYPICAL)

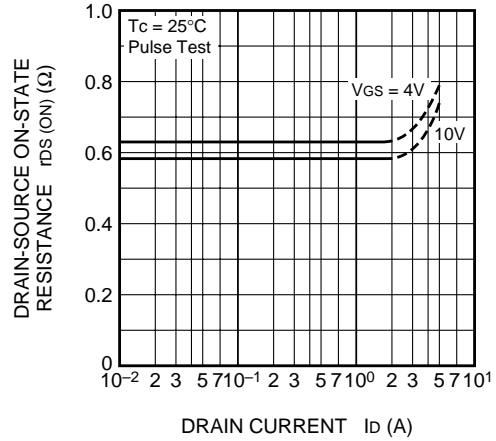

TRANSFER CHARACTERISTICS (TYPICAL)

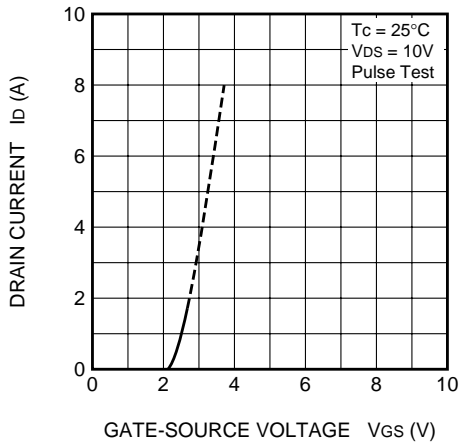

FORWARD TRANSFER ADMITTANCE VS. DRAIN CURRENT (TYPICAL)

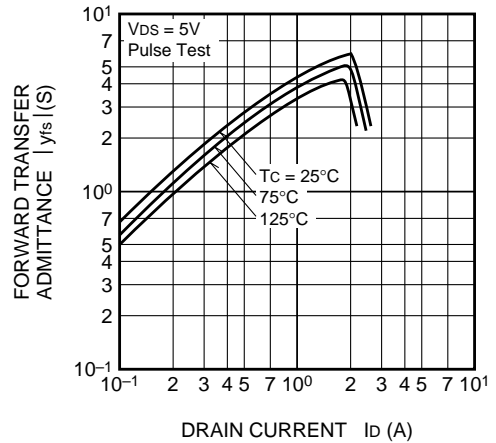

CAPACITANCE VS. DRAIN-SOURCE VOLTAGE (TYPICAL)

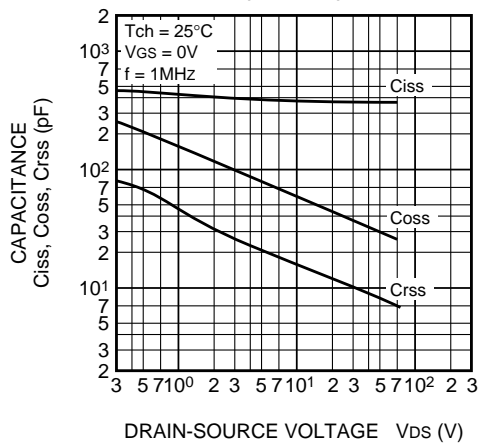

SWITCHING CHARACTERISTICS (TYPICAL)

