

FS5KMH-2

HIGH-SPEED SWITCHING USE

FS5KMH-2



- 2.5V DRIVE
- V_{DSS} 100V
- r_{DS (ON)} (MAX) 0.44Ω
- I_D 5A
- Integrated Fast Recovery Diode (TYP.) 80ns
- V_{iso} 2000V

OUTLINE DRAWING

Dimensions in mm

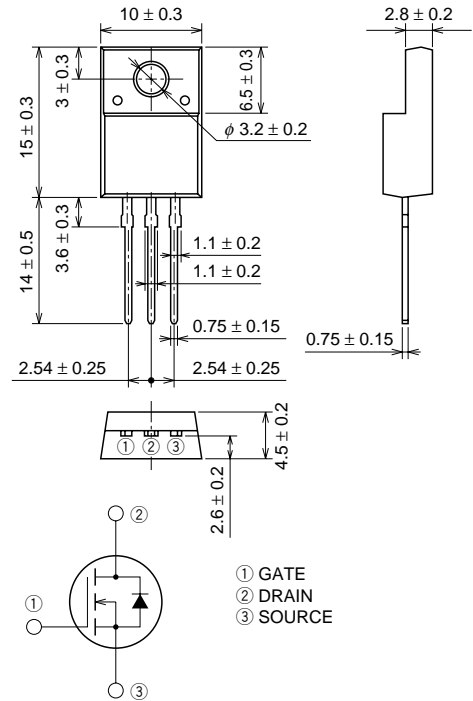

TO-220FN

APPLICATION

Motor control, Lamp control, Solenoid control
DC-DC converter, etc.

MAXIMUM RATINGS (T_c = 25°C)

Symbol	Parameter	Conditions	Ratings	Unit
V _{DSS}	Drain-source voltage	V _{GS} = 0V	100	V
V _{GSS}	Gate-source voltage	V _{DS} = 0V	±10	V
I _D	Drain current		5	A
I _{DM}	Drain current (Pulsed)		20	A
I _{DA}	Avalanche drain current (Pulsed)	L = 100μH	5	A
I _S	Source current		5	A
I _{SM}	Source current (Pulsed)		20	A
P _D	Maximum power dissipation		15	W
T _{ch}	Channel temperature		-55 ~ +150	°C
T _{stg}	Storage temperature		-55 ~ +150	°C
V _{iso}	Isolation voltage	AC for 1minute, Terminal to case	2000	V
—	Weight	Typical value	2.0	g

ELECTRICAL CHARACTERISTICS (Tch = 25°C)

Symbol	Parameter	Test conditions	Limits			Unit
			Min.	Typ.	Max.	
V (BR) DSS	Drain-source breakdown voltage	ID = 1mA, VGS = 0V	100	—	—	V
IGSS	Gate-source leakage current	VGS = ±10V, VDS = 0V	—	—	±0.1	μA
IDSS	Drain-source leakage current	VDS = 100V, VGS = 0V	—	—	0.1	mA
VGS (th)	Gate-source threshold voltage	ID = 1mA, VDS = 10V	0.6	0.9	1.2	V
rDS (ON)	Drain-source on-state resistance	ID = 2A, VGS = 4V	—	0.32	0.44	Ω
rDS (ON)	Drain-source on-state resistance	ID = 2A, VGS = 2.5V	—	0.34	0.47	Ω
VDS (ON)	Drain-source on-state voltage	ID = 2A, VGS = 4V	—	0.64	0.88	V
yfs	Forward transfer admittance	ID = 2A, VDS = 5V	—	10	—	S
Ciss	Input capacitance	VDS = 10V, VGS = 0V, f = 1MHz	—	540	—	pF
Coss	Output capacitance		—	75	—	pF
Crss	Reverse transfer capacitance		—	20	—	pF
td (on)	Turn-on delay time	VDD = 50V, ID = 2A, VGS = 4V, RGEN = RGS = 50Ω	—	12	—	ns
tr	Rise time		—	18	—	ns
td (off)	Turn-off delay time		—	45	—	ns
tf	Fall time		—	26	—	ns
VSD	Source-drain voltage	IS = 2A, VGS = 0V	—	1.0	1.5	V
Rth (ch-c)	Thermal resistance	Channel to case	—	—	8.33	°C/W
trr	Reverse recovery time	IS = 5A, dis/dt = -100A/μs	—	80	—	ns

PERFORMANCE CURVES

POWER DISSIPATION DERATING CURVE

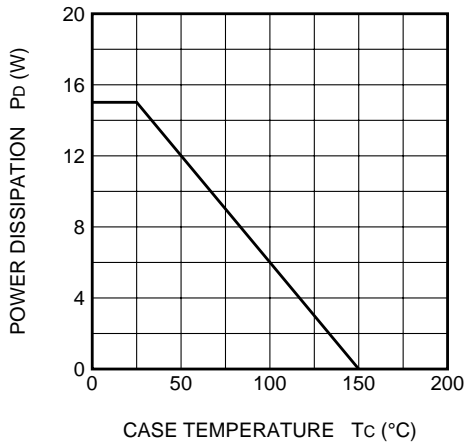

MAXIMUM SAFE OPERATING AREA

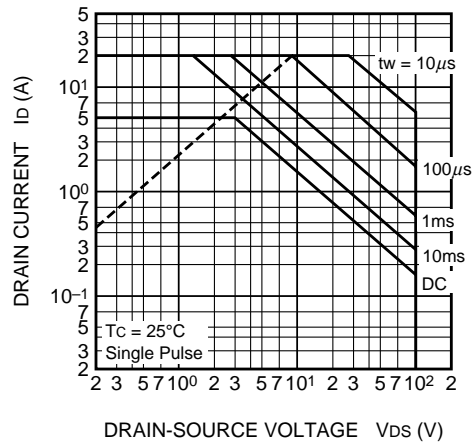

OUTPUT CHARACTERISTICS (TYPICAL)

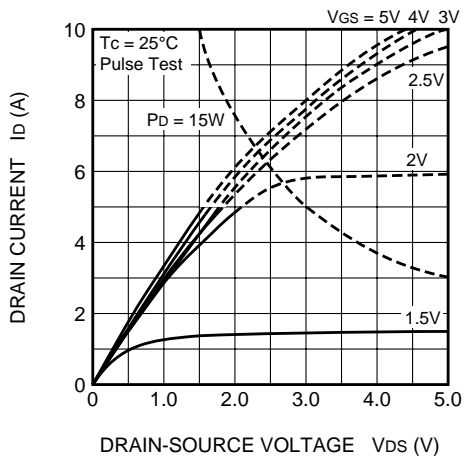

OUTPUT CHARACTERISTICS (TYPICAL)

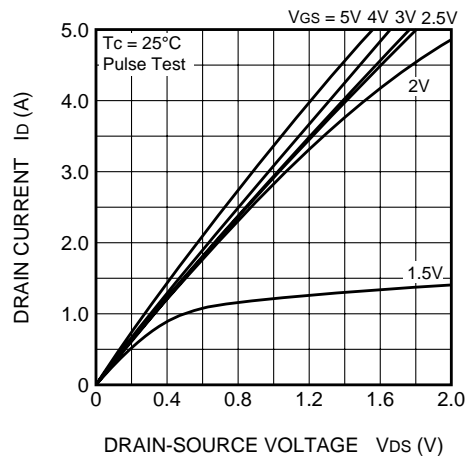

ON-STATE VOLTAGE VS. GATE-SOURCE VOLTAGE (TYPICAL)

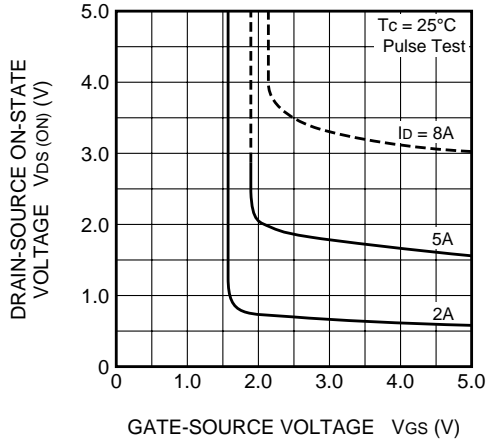

ON-STATE RESISTANCE VS. DRAIN CURRENT (TYPICAL)

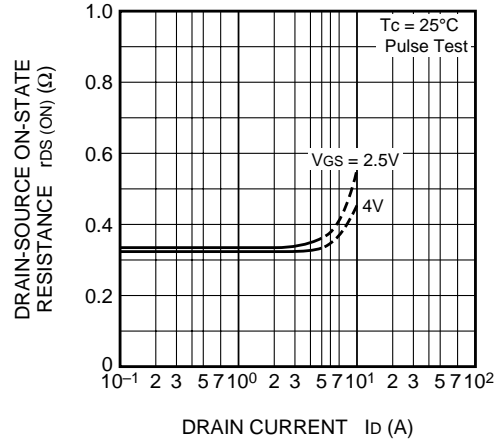

TRANSFER CHARACTERISTICS (TYPICAL)

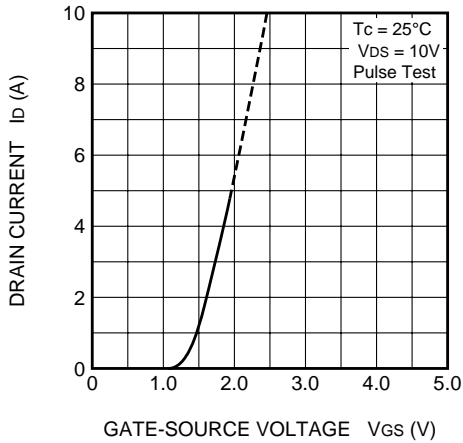

FORWARD TRANSFER ADMITTANCE VS. DRAIN CURRENT (TYPICAL)

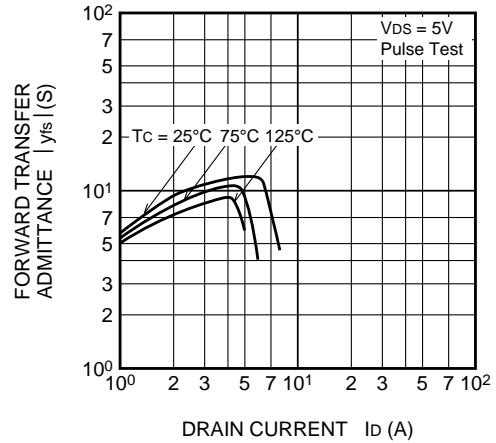

CAPACITANCE VS. DRAIN-SOURCE VOLTAGE (TYPICAL)

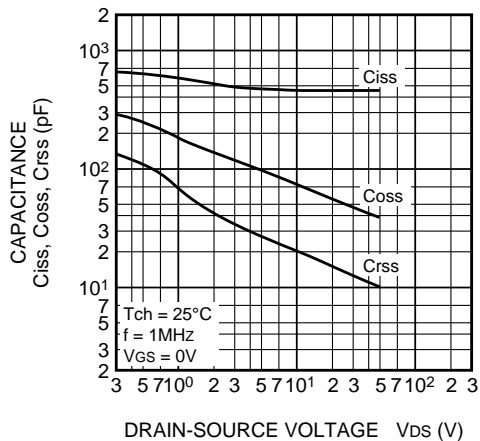

SWITCHING CHARACTERISTICS (TYPICAL)

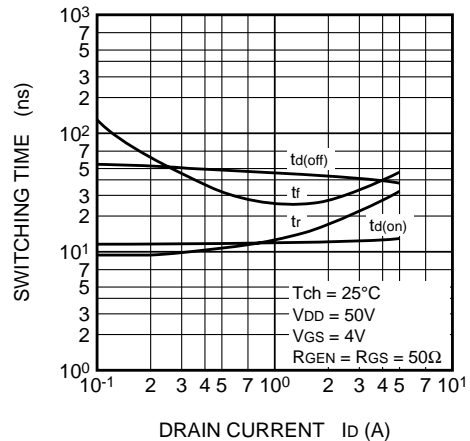

GATE-SOURCE VOLTAGE VS. GATE CHARGE (TYPICAL)

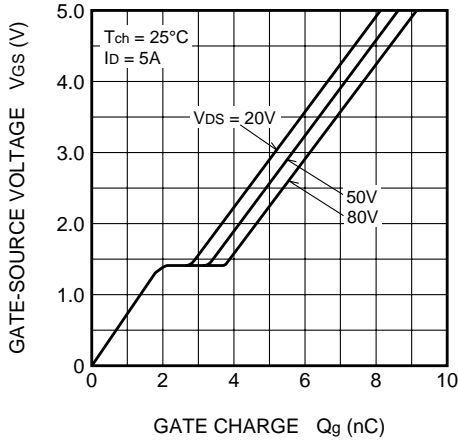

SOURCE-DRAIN DIODE FORWARD CHARACTERISTICS (TYPICAL)

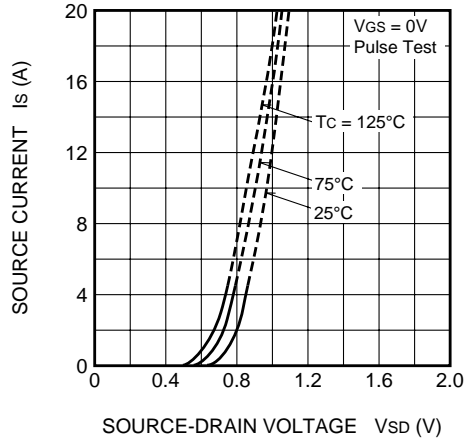

ON-STATE RESISTANCE VS. CHANNEL TEMPERATURE (TYPICAL)

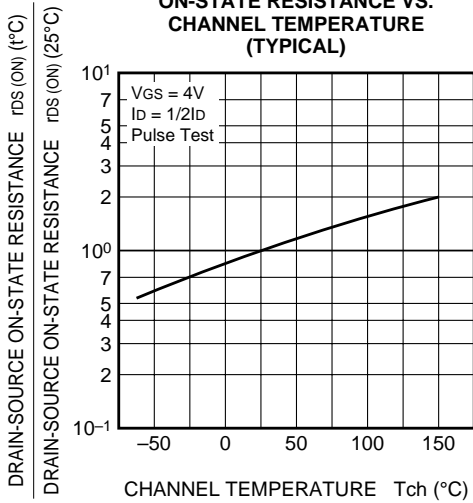

THRESHOLD VOLTAGE VS. CHANNEL TEMPERATURE (TYPICAL)

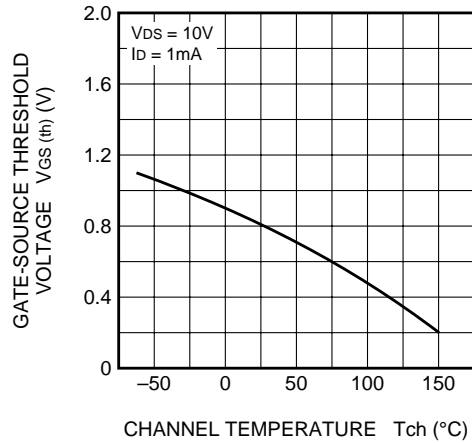

BREAKDOWN VOLTAGE VS. CHANNEL TEMPERATURE (TYPICAL)

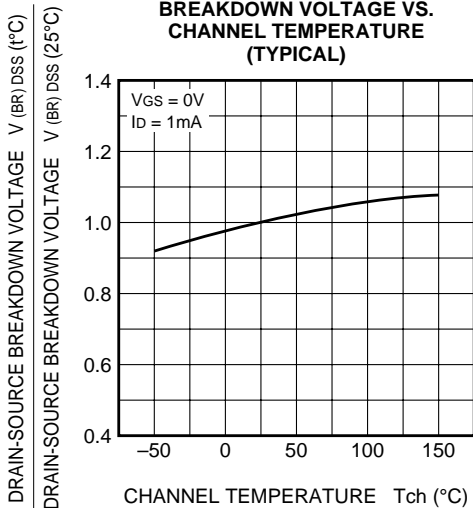

TRANSIENT THERMAL IMPEDANCE CHARACTERISTICS

