

**PRELIMINARY**  
 Notice: This is not a final specification.  
 Some parametric limits are subject to change.

MITSUBISHI Pch POWER MOSFET

# FX20VSJ-3

HIGH-SPEED SWITCHING USE

**FX20VSJ-3**



- 4V DRIVE
- $V_{DSS}$  ..... -150V
- $r_{DS(ON)}$  (MAX) .....  $0.29\Omega$
- $I_D$  ..... -20A
- Integrated Fast Recovery Diode (TYP.) ..... 100ns

**OUTLINE DRAWING** Dimensions in mm

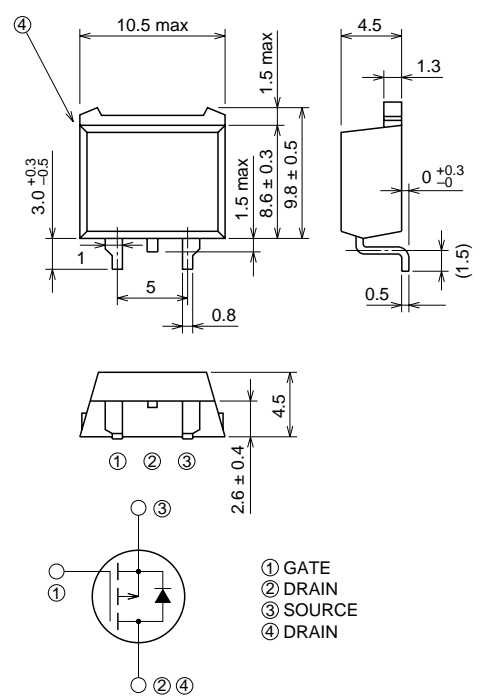

**TO-220S**

## APPLICATION

Motor control, Lamp control, Solenoid control  
 DC-DC converter, etc.

## MAXIMUM RATINGS (Tc = 25°C)

Symbol	Parameter	Conditions	Ratings	Unit
$V_{DSS}$	Drain-source voltage	$V_{GS} = 0V$	-150	V
$V_{GSS}$	Gate-source voltage	$V_{DS} = 0V$	$\pm 20$	V
$I_D$	Drain current		-20	A
$I_{DM}$	Drain current (Pulsed)		-80	A
$I_{DA}$	Avalanche drain current (Pulsed)	$L = 30\mu H$	-20	A
$I_S$	Source current		-20	A
$I_{SM}$	Source current (Pulsed)		-80	A
$P_D$	Maximum power dissipation		70	W
$T_{ch}$	Channel temperature		-55 ~ +150	°C
$T_{stg}$	Storage temperature		-55 ~ +150	°C
—	Weight	Typical value	1.2	g

Jan.1999

**PRELIMINARY**  
 Notice: This is not a final specification.  
 Some parametric limits are subject to change.

**ELECTRICAL CHARACTERISTICS** (Tch = 25°C)

Symbol	Parameter	Test conditions	Limits			Unit
			Min.	Typ.	Max.	
V(BR)DSS	Drain-source breakdown voltage	ID = -1mA, VGS = 0V	-150	—	—	V
IGSS	Gate-source leakage current	VGS = ±20V, VDS = 0V	—	—	±0.1	μA
IDSS	Drain-source leakage current	VDS = -150V, VGS = 0V	—	—	-0.1	mA
VGS(th)	Gate-source threshold voltage	ID = -1mA, VDS = -10V	-1.0	-1.5	-2.0	V
rDS(ON)	Drain-source on-state resistance	ID = -10A, VGS = -10V	—	0.23	0.29	Ω
rDS(ON)	Drain-source on-state resistance	ID = -10A, VGS = -4V	—	0.25	0.32	Ω
VDS(ON)	Drain-source on-state voltage	ID = -10A, VGS = -10V	—	-2.3	-2.9	V
yfs	Forward transfer admittance	ID = -10A, VDS = -10V	—	17.5	—	S
Ciss	Input capacitance	VDS = -10V, VGS = 0V, f = 1MHz	—	4470	—	pF
Coss	Output capacitance		—	248	—	pF
Crss	Reverse transfer capacitance		—	115	—	pF
td(on)	Turn-on delay time		—	15	—	ns
tr	Rise time	VDD = -80V, ID = -10A, VGS = -10V, RGEN = RGS = 50Ω	—	42	—	ns
td(off)	Turn-off delay time		—	273	—	ns
tf	Fall time		—	114	—	ns
VSD	Source-drain voltage		IS = -10A, VGS = 0V	—	-1.0	-1.5
Rth(ch-c)	Thermal resistance	Channel to case	—	—	1.79	°C/W
trr	Reverse recovery time	IS = -20A, dis/dt = 100A/μs	—	100	—	ns

**PERFORMANCE CURVES**

**POWER DISSIPATION DERATING CURVE**

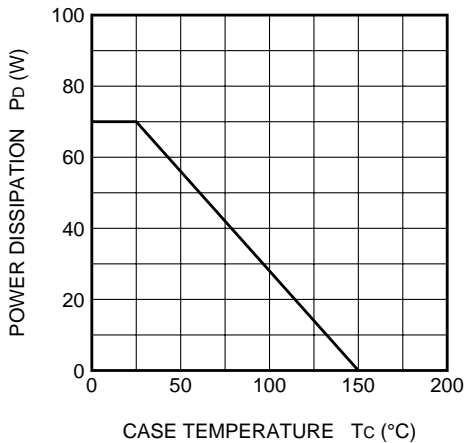

**MAXIMUM SAFE OPERATING AREA**

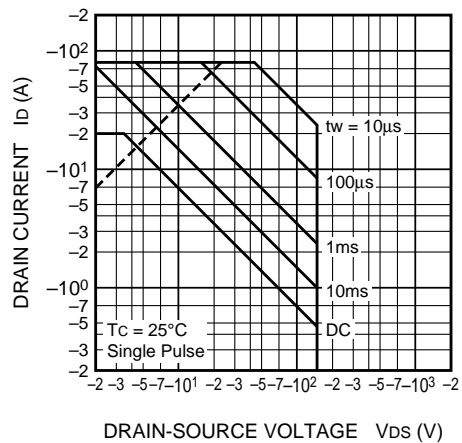

**OUTPUT CHARACTERISTICS (TYPICAL)**

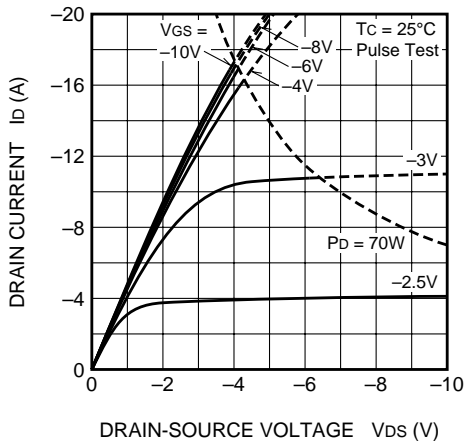

**OUTPUT CHARACTERISTICS (TYPICAL)**

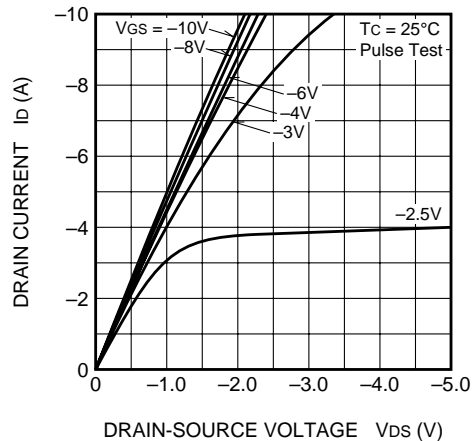

**PRELIMINARY**  
 Notice: This is not a final specification.  
 Some parametric limits are subject to change.

**ON-STATE VOLTAGE VS. GATE-SOURCE VOLTAGE (TYPICAL)**

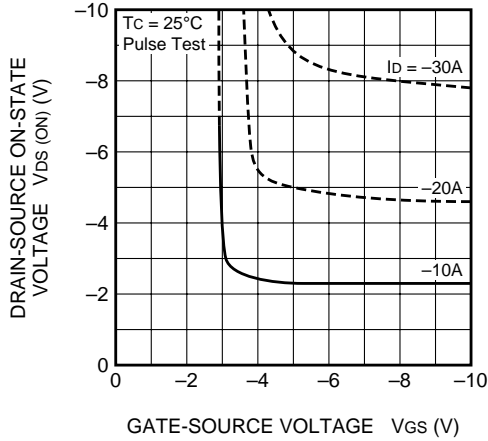

**ON-STATE RESISTANCE VS. DRAIN CURRENT (TYPICAL)**

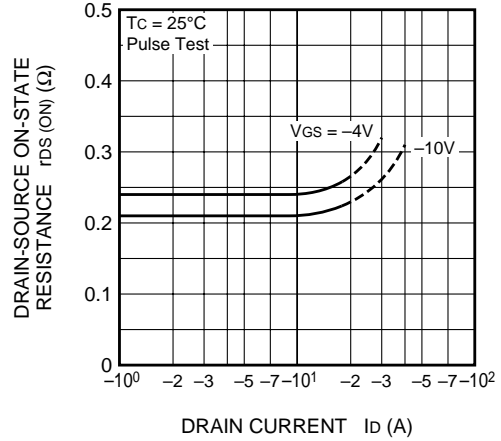

**TRANSFER CHARACTERISTICS (TYPICAL)**

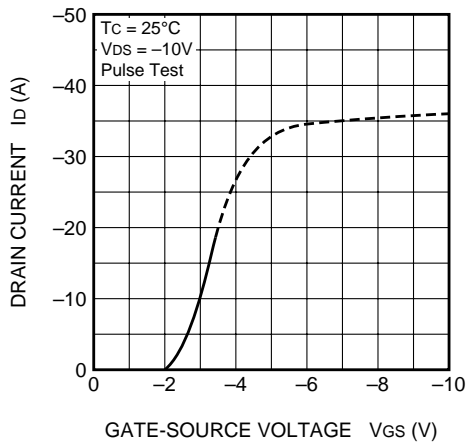

**FORWARD TRANSFER ADMITTANCE VS. DRAIN CURRENT (TYPICAL)**

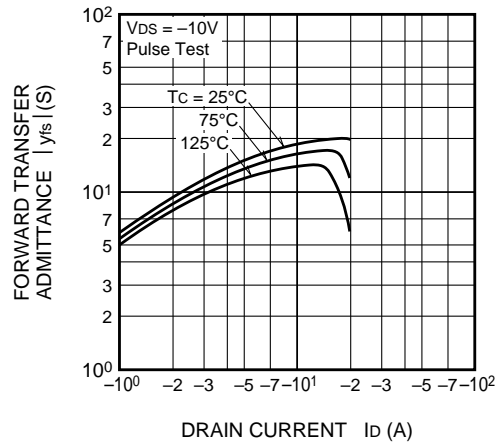

**CAPACITANCE VS. DRAIN-SOURCE VOLTAGE (TYPICAL)**

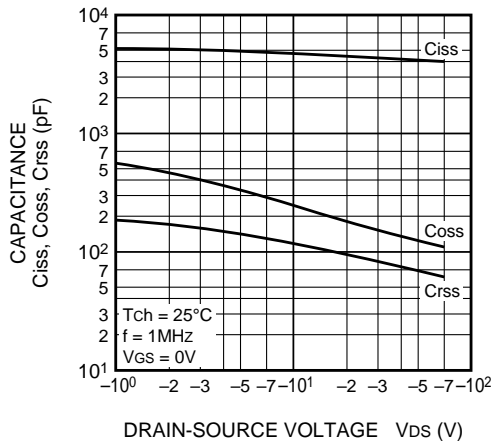

**SWITCHING CHARACTERISTICS (TYPICAL)**

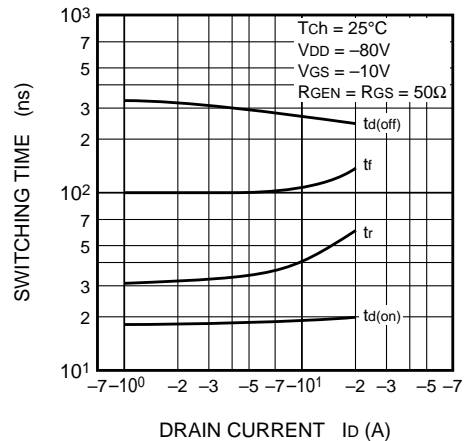

**PRELIMINARY**  
 Notice: This is not a final specification.  
 Some parametric limits are subject to change.

