

Powerex, Inc., 200 Hillis Street, Youngwood, Pennsylvania 15697-1800 (412) 925-7272
Powerex, Europe, S.A. 428 Avenue G. Durand, BP107, 72003 Le Mans, France (43) 41.14.14

Phase Control SCR
750 Amperes Average
1600 Volts

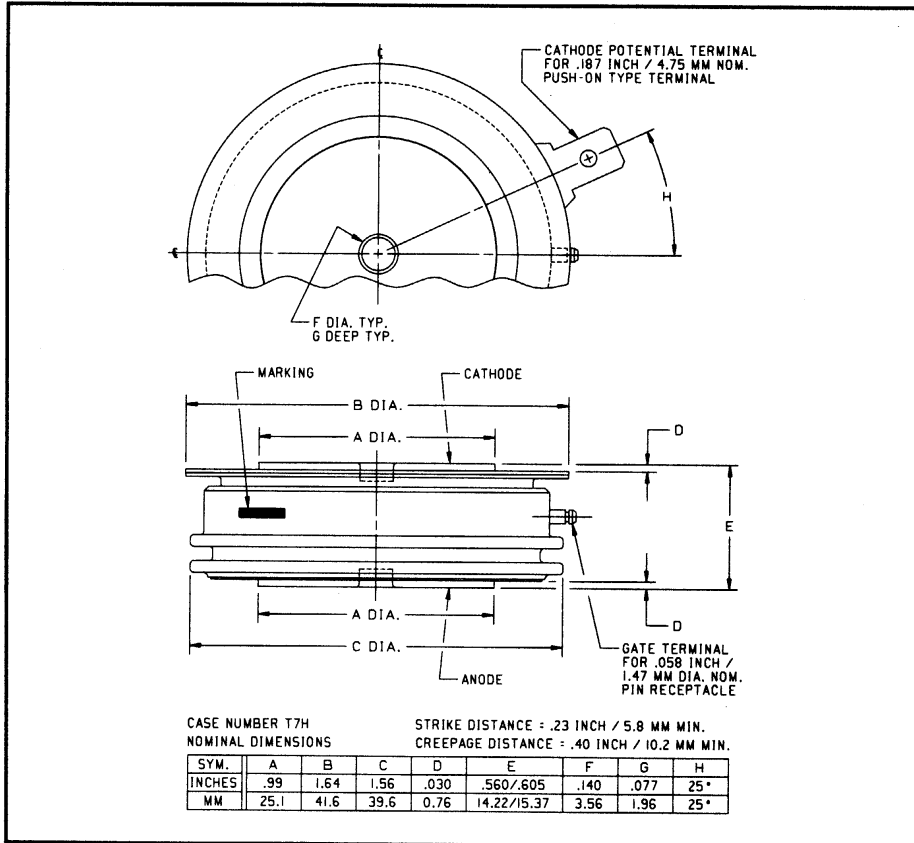

T7S0 750A (1600V) (Outline Drawing)

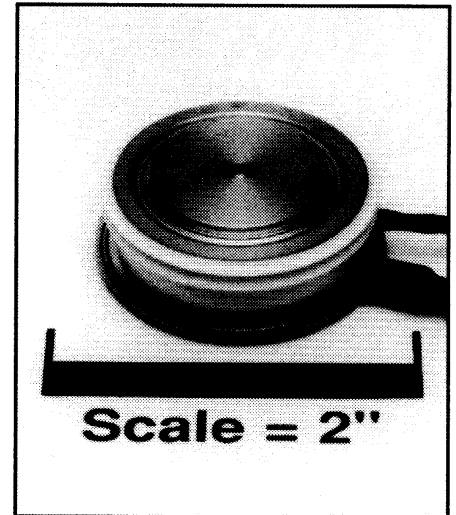

T7S0 750A (1600V) Phase Control SCR
750 Amperes Average, 1600 Volts

Description:

Powerex Silicon Controlled Rectifiers (SCR) are designed for phase control applications. These are all-diffused, Press-Pak, hermetic Pow-R-Disc devices employing the field proven amplifying gate.

Features:

- Low On-State Voltage
- High di/dt Capability
- High dv/dt Capability
- Hermetic Packaging
- Excellent Surge and i^2t Ratings

Applications:

- Power Supplies
- Motor Control

Ordering Information:

Select the complete 12 digit part number you desire from the table below.

Type	Voltage	Current	Turn-off	Gate Current	Lead Code
	V_{DRM}/V_{RRM} (Volts)	$I_T(av)$ (A)	t_q (μ sec)	I_{GT} (mA)	
T7S0	02 through 16	75	0	4	DN
	200V through 1600V	750A	150 μ sec (Typical)	150mA	8"



Powerex, Inc., 200 Hillis Street, Youngwood, Pennsylvania 15697-1800 (412) 925-7272
 Powerex, Europe, S.A. 428 Avenue G. Durand, BP107, 72003 Le Mans, France (43) 41.14.14

T7S0 750A (1600V)
Phase Control SCR
 750 Amperes Average, 1600 Volts

Absolute Maximum Ratings

Characteristics	Symbol	T7S0 750A (1600V)	Units
Non-repetitive Transient Peak Reverse Voltage	V_{RSM}	$V_{RRM} + 100V$	Volts
RMS On-state Current, $T_C = 62^\circ C$	$I_{T(rms)}$	1180	Amperes
Average Current 180° Sine Wave, $T_C = 62^\circ C$	$I_{T(av)}$	750	Amperes
RMS On-state Current, $T_C = 55^\circ C$	$I_{T(rms)}$	1260	Amperes
Average Current 180° Sine Wave, $T_C = 55^\circ C$	$I_{T(av)}$	800	Amperes
Peak One Cycle Surge On-state Current (Non-repetitive) 60Hz	I_{tsm}	10500	Amperes
Peak One Cycle Surge On-state Current (Non-repetitive) 50Hz	I_{tsm}	9600	Amperes
Critical Rate-of-rise of On-state Current (Non-repetitive)	di/dt	600	A/ μ sec
Critical Rate-of-rise of On-state Current (Repetitive)	di/dt	150	A/ μ sec
I^2t (for Fusing) for One Cycle, 60Hz	I^2t	460,000	A ² sec
Peak Gate Power Dissipation	P_{GM}	16	Watts
Average Gate Power Dissipation	$P_{G(av)}$	3	Watts
Operating Temperature	T_j	-40 to +125°C	°C
Storage Temperature	T_{stg}	-40 to +150°C	°C
Approximate Weight		4	oz.
		113	g
Mounting Force		2000 to 2400	lb.
		900 to 1090	kg.



Powerex, Inc., 200 Hillis Street, Youngwood, Pennsylvania 15697-1800 (412) 925-7272
 Powerex, Europe, S.A. 428 Avenue G. Durand, BP107, 72003 Le Mans, France (43) 41.14.14

T7S0 750A (1600V)
 Phase Control SCR
 750 Amperes Average, 1600 Volts

Electrical Characteristics, $T_j = 25^\circ\text{C}$ Unless Otherwise Specified

Characteristics	Symbol	Test Conditions	Min.	Typ.	Max.	Units
Repetitive Peak Reverse Leakage Current	I_{RRM}	$T_j = 125^\circ\text{C}$, $V_R = V_{RRM}$			30	mA
Repetitive Peak Forward Leakage Current	I_{DRM}	$T_j = 125^\circ\text{C}$, $V_D = V_{DRM}$			30	mA
Peak On-state Voltage	V_{TM}	$I_{TM} = 625\text{A Peak}$ Duty Cycle < 0.1%			1.40	Volts
Threshold Voltage, Low-level	$V_{(TO)1}$	$T_j = 125^\circ\text{C}$, $I = 15\%$, $I_{T(av)}$ to $\pi I_{T(av)}$			0.97192	Volts
Slope Resistance, Low-level	r_{T1}				0.4818	m Ω
Threshold Voltage, High-level	$V_{(TO)2}$	$T_j = 125^\circ\text{C}$, $I = \pi I_{T(av)}$ to I_{TSM}			1.4824	Volts
Slope Resistance, High-level	r_{T2}				0.2845	m Ω
V_{TM} Coefficients, Low-level		$T_j = 125^\circ\text{C}$, $I = 15\%$ $I_{T(av)}$ to $\pi I_{T(av)}$				$A_1 = 0.38516$ $B_1 = 0.12628$ $C_1 = 4.189\text{E-}04$ $D_1 = -0.005704$
V_{TM} Coefficients, High-level		$T_j = 125^\circ\text{C}$, $I = \pi I_{T(av)}$ to I_{TSM}				$A_2 = 2.1990$ $B_2 = -0.30712$ $C_2 = 4.831\text{E-}05$ $D_2 = 0.044366$
Typical Turn-on Time	t_{on}	$I_T = 100\text{A}$, $V_D = 100\text{V}$		7		μsec
Typical Turn-off Time	t_q	$T_j = 125^\circ\text{C}$, $I_T = 250\text{A}$, $di/dt = 25\text{A}/\mu\text{sec}$ Reapplied $dv/dt = 20\text{V}/\mu\text{sec}$ Linear to 80% V_{DRM}		150		μsec
Minimum Critical dv/dt - Exponential to V_{DRM}	dv/dt	$T_j = 125^\circ\text{C}$	300			V/ μsec
Gate Trigger Current	I_{GT}	$T_j = 25^\circ\text{C}$, $V_D = 12\text{V}$			150	mA
Gate Trigger Voltage	V_{GT}	$T_j = 25^\circ\text{C}$, $V_D = 12\text{V}$			3.0	Volts
Non-Triggerring Gate Voltage	V_{GDM}	$T_j = 125^\circ\text{C}$, $V_D = V_{DRM}$			0.15	Volts
Peak Forward Gate Current	I_{GTM}				4	A
Peak Reverse Gate Voltage	V_{GRM}				5	Volts

Thermal Characteristics

Maximum Thermal Resistance, Double Sided Cooling						
Junction-to-Case	$R_{\theta(j-c)}$				0.04	$^\circ\text{C}/\text{W}$
Case-to-Sink	$R_{\theta(c-s)}$				0.02	$^\circ\text{C}/\text{W}$

Powerex, Inc., 200 Hillis Street, Youngwood, Pennsylvania 15697-1800 (412) 925-7272
 Powerex, Europe, S.A. 428 Avenue G. Durand, BP107, 72003 Le Mans, France (43) 41.14.14

T7S0 750A (1600V)
Phase Control SCR
 750 Amperes Average, 1600 Volts

Maximum On-State Forward Voltage Drop
 (T_J = 125 °C)

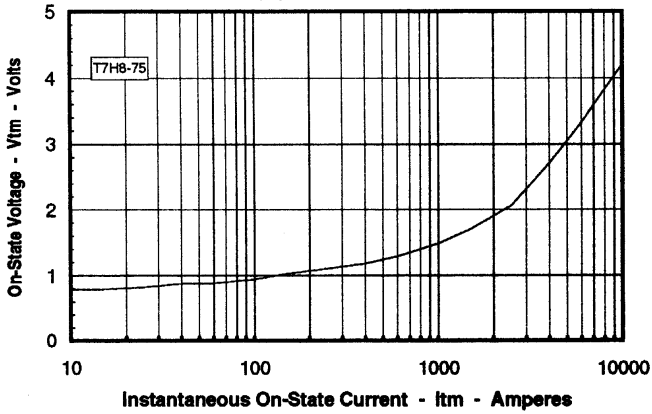

Maximum Transient Thermal Impedance
 (Junction to Case)

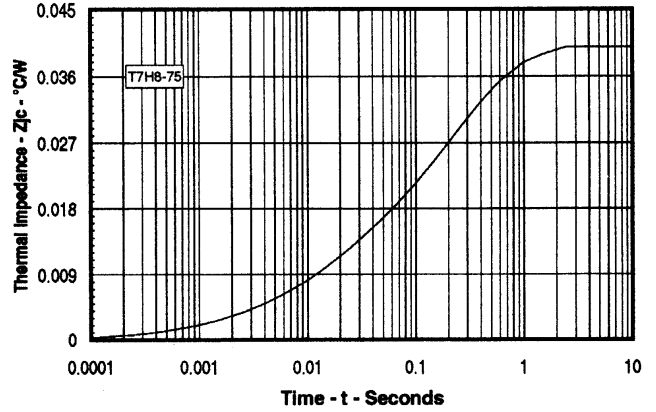

Maximum On-State Power Dissipation
 (Sinusoidal Waveform)

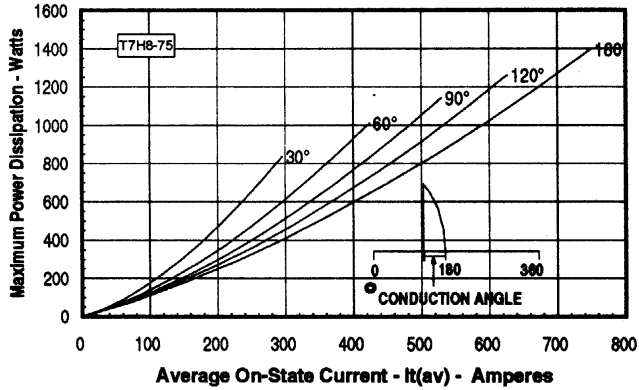

Maximum Allowable Case Temperature
 (Sinusoidal Waveform)

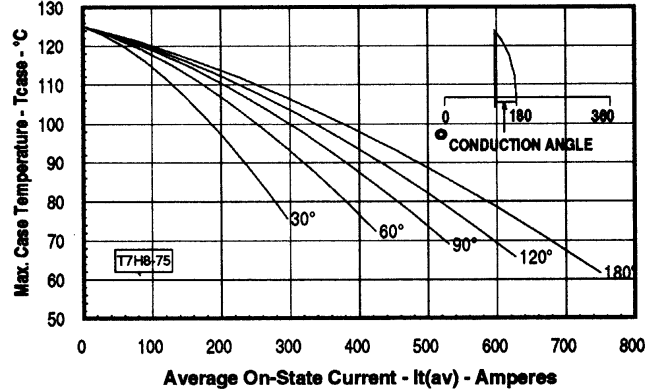

Maximum On-State Power Dissipation
 (Rectangular Waveform)

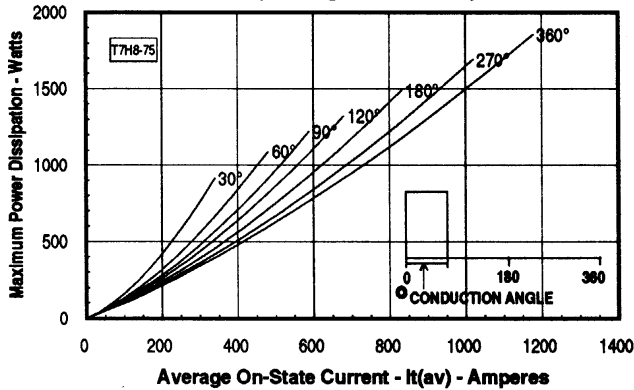

Maximum Allowable Case Temperature
 (Rectangular Waveform)

