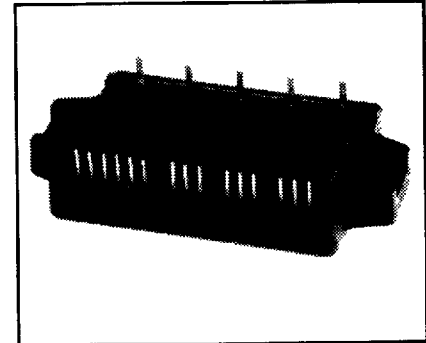
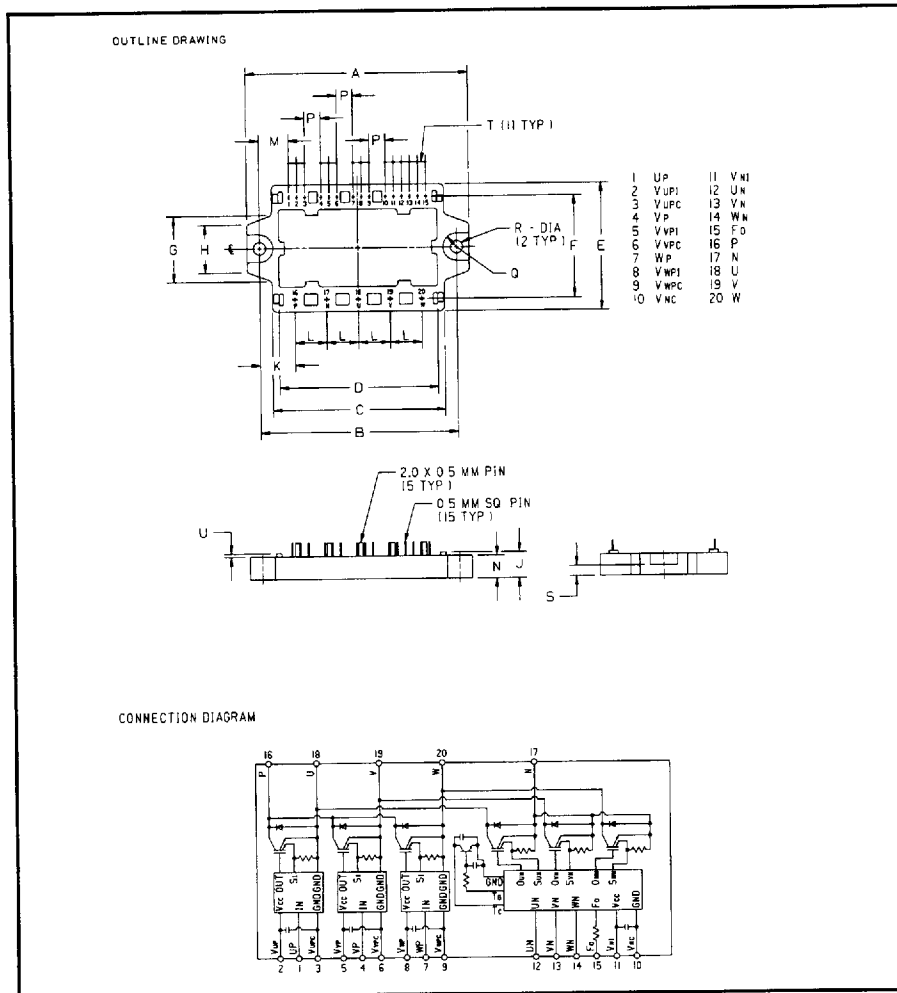




Powerex, Inc., Hillis Street, Youngwood, Pennsylvania 15697 (412) 925-7272  
 Powerex, Europe, S.A. 428 Avenue G. Durand, BP107, 72003 Le Mans, France (43) 41.14.14

**Intellimod™-3 Modules**  
 Three Phase  
 IGBT Inverter Output  
 15 Amperes/110-230 Volt Line



**Description**

Powerex Intellimod-3 Modules are designed for applications requiring a high frequency (20kHz) output switching inverter. The modules are isolated from the baseplate, consisting of complete drive, control and protection circuitry for the IGBT inverter.

**Features:**

- Complete Output Power Circuit
- Gate Drive Circuit
- Protection Logic
  - Short Circuit
  - Over-Current
  - Over Temperature
  - Under Voltage

**Applications:**

- Inverters
- Small UPS
- Motion/Servo Control
- AC Motor Control

**Ordering Information**  
 PM15CHA060

110-230 Volt Line, PM15CHA060 Outline Drawing

Dimensions	Inches	Millimeters
A	3.86±0.04	98.0±1.0
B	3.42±0.02	87.0±0.5
C	2.99	76.0
D	2.76	70.0
E	2.20±0.04	56.0±1.0
F	1.77	45.0
G	1.14	29.0
H	0.83	21.0
J	0.63	16.0
K	0.61	15.5

Dimensions	Inches	Millimeters
L	0.55	14.0
M	0.521	13.24
N	0.39	10.0
P	0.28	7.12
Q	0.24R	6.0R
R	0.22 Dia.	5.5 Dia
S	0.20	5.0
T	0.14	3.56
U	0.06	1.5V



POWEREX INC

51E D 7294621 0005651 706 PRX

Powerex, Inc., Hillis Street, Youngwood, Pennsylvania 15697 (412) 925-7272

Powerex, Europe, S.A. 428 Avenue G. Durand, BP107, 72003 Le Mans, France (43) 41.14.14

PM15CHA060

Intellimod-3 Modules

Three Phase IGBT Inverter Output

15 Amperes/110-230 Volt Line

T-57-29

**Absolute Maximum Ratings,  $T_j = 25\text{ }^\circ\text{C}$  unless otherwise specified**

Characteristics	Symbol	PM15CHA060	Units
Power Device Junction Temperature	$T_j$	-20 to +150	$^\circ\text{C}$
Storage Temperature	$T_{STG}$	-40 to +125	$^\circ\text{C}$
Case Operating Temperature	$T_C$	-20 to +100	$^\circ\text{C}$
Mounting Torque, M5 Mounting Screws	—	17	Kg-cm
Module Weight (Typical)	—	90	Grams
Supply Voltage Protected by OC and SC ( $V_D = 13.5 - 16.5\text{ V}$ , Inverter Part)	$V_{CC(prot.)}$	400	Volts
Isolation Voltage AC 1 minute, 60Hz	$V_{RMS}$	2500	Volts

**Control Sector**

Supply Voltage Applied Between ( $V_{UP1} - V_{UPC}, V_{VP1} - V_{VPC}, V_{WP1} - V_{WPC}, V_{N1} - V_{NC}$ )	$V_D$	20	Volts
Input Current Applied Between ( $U_P, V_P, W_P, U_N, V_N, W_N$ )	$I_{CIN}$	20	mA
Input Voltage Applied Between ( $U_P, V_P, W_P, U_N, V_N, W_N$ )	$V_{CIN}$	20	Volts
Fault Output Supply Voltage	$V_{FO}$	20	Volts
Fault Output Current	$I_{FO}$	20	mA

**IGBT Inverter Sector**

Collector-Emitter Voltage Fig. 1	$V_{CES}$	600	Volts
Collector Current $\pm$	$I_C$	15	Amperes
Peak Collector Current $\pm$	$I_{CP}$	30	Amperes
Supply Voltage (Applied between P - N)	$V_{CC}$	400	Volts
Supply Voltage (Surge) Applied between P - N	$V_{CC(surge)}$	500	Volts
Collector Dissipation	$P_C$	43	Watts



POWEREX INC

51E D ■ 7294621 0005652 642 ■ PRX

Powerex, Inc., Hillis Street, Youngwood, Pennsylvania 15697 (412) 925-7272  
 Powerex, Europe, S.A. 428 Avenue G. Durand, BP107, 72003 Le Mans, France (43) 41.14.14

T-57-29

PM15CHA060  
 Intellimod-3 Modules  
 Three Phase IGBT Inverter Output  
 15 Amperes/110-230 Volt Line

**Electrical Characteristics,  $T_j = 25\text{ }^\circ\text{C}$  unless otherwise specified**

Characteristics	Symbol	Test Conditions	Min.	Typ.	Max.	Units
<b>Control Sector</b>						
Overcurrent Trip Level Inverter Part	OC	$-20^\circ\text{C} \leq T \leq +125^\circ\text{C}$	18	26	–	Amperes
Short Circuit Trip Level Inverter Part	SC	$-20^\circ\text{C} \leq T \leq +125^\circ\text{C}$	–	39	–	Amperes
Overcurrent Delay Time	$t_{off(OC)}$	$V_D = 15\text{V}$ , Fig. 7	–	10	–	$\mu\text{S}$
Over Temperature Protection	OT	Trip Level	100	110	120	$^\circ\text{C}$
Over Temperature Protection	$OT_R$	Reset Level	–	90	–	$^\circ\text{C}$
Supply Circuit Under Voltage Protection	UV	Trip Level	11.5	12.0	12.5	Volts
Supply Circuit Under Voltage Protection	$UV_R$	Reset Level	–	12.5	–	Volts
Supply Voltage	$V_D$	Applied between $V_{UP1} - V_{UPC}$ , $V_{VP1} - V_{VPC}$ , $V_{WP1} - V_{WPC}$ , $V_{N1} - V_{NC}$	13.5	15	16.5	Volts
Circuit Current	$I_D$	$V_D = 15\text{V}$ , $I_{CIN} = 1\text{mA}$ , $V_{N1} - V_{NC}$	–	25	40	mA
	$I_D$	$V_D = 15\text{V}$ , $I_{CIN} = 1\text{mA}$ , $V_{XP1} - V_{XPC}$	–	7	12	mA
Input Bias On Current	$I_{CIN(on)}$	Sink Current at $U_P, V_P, W_P, U_N, V_N, W_N$	0.1	0.22	0.5	mA
Input Bias Off Current	$I_{CIN(off)}$	Sink current at $U_P, V_P, W_P, U_N, V_N, W_N$	0.1	0.22	0.5	mA
PWM Input Frequency	$f_{PWM}$	3- $\emptyset$ Sinusoidal	–	15	20	kHz
Dead Time	$t_{DEAD}$	For each Input Pulse	2.0	–	–	$\mu\text{S}$
		Using example Interface Circuit*	5.0	–	–	$\mu\text{S}$
Fault Output Current	$I_{FO(H)}$	$V_D = 15\text{V}$ , $V_{FO} = 15\text{V}$	–	–	0.01	mA
	$I_{FO(L)}$	$V_D = 15\text{V}$ , $V_{FO} = 15\text{V}$	–	10	15	mA
Minimum Fault Output Pulse Width	$t_{FO}$	$V_D = 15\text{V}$	20	40	60	$\mu\text{S}$
		Using example Interface Circuit* $V_D = 15\text{V}$	25	100	–	$\mu\text{S}$

\*See Intellimod-3 Applications Data Section 4.3



POWEREX INC

51E D ■ 729462J 0005653 589 ■ PRX

Powerex, Inc., Hillis Street, Youngwood, Pennsylvania 15697 (412) 925-7272  
 Powerex, Europe, S.A. 428 Avenue G. Durand, BP107, 72003 Le Mans, France (43) 41.14.14

PM15CHA060  
 Intellimod-3 Modules  
 Three Phase IGBT Inverter Output  
 15 Amperes/110-230 Volt Line

T-57-29

**Electrical Characteristics,  $T_J = 25\text{ }^\circ\text{C}$  unless otherwise specified**

Characteristics	Symbol	Test Conditions	Min.	Typ.	Max.	Units
<b>IGBT Inverter Sector</b>						
Collector Cutoff Current	$I_{CEX}$	$V_{CE} = V_{CEX}, T_J = 25\text{ }^\circ\text{C}$ , Fig. 6	-	-	1	mA
Collector Cutoff Current	$I_{CEX}$	$V_{CE} = V_{CEX}, T_J = 125\text{ }^\circ\text{C}$ , Fig. 6	-	-	10	mA
Diode Forward Voltage	$V_{FM}$	$-I_C = 10\text{A}, V_D = 15\text{V}, I_{CIN} = 1\text{mA}$ , Fig. 3	-	1.7	2.5	Volts
Collector Emitter Saturation Voltage	$V_{CE(sat)}$	$V_D = 15\text{V}, I_{CIN} = 0\text{mA}, I_C = 10\text{A}$ , Fig. 2	-	2.6	3.5	Volts
Collector Emitter Saturation Voltage	$V_{CE(sat)}$	$V_D = 15\text{V}, I_{CIN} = 0\text{mA}, I_C = 10\text{A}$ , $T_J = 125\text{ }^\circ\text{C}$ , Fig. 2	-	2.5	3.4	Volts
Inductive Load Switching Times	$t_{on}$	$V_D = 15\text{V}, I_{CIN} = 0\text{mA}$ ,	0.5	0.9	1.5	$\mu\text{S}$
	$t_{rr}$	$V_{CC} = 300\text{V}, I_C = 10\text{A}$ ,	-	0.15	0.4	$\mu\text{S}$
	$t_{C(on)}$	$T_J = 125\text{ }^\circ\text{C}$ ,	-	0.3	1.0	$\mu\text{S}$
	$t_{off}$	Fig. 4, Fig. 5	-	1.5	2.5	$\mu\text{S}$
	$t_{C(off)}$		-	0.5	1.5	$\mu\text{S}$

**Thermal Characteristics**

Characteristics	Symbol	Test Conditions	Min.	Typ.	Max.	Units
Junction to Case Thermal Resistances	$R_{th(l-c)Q}$	Inverter IGBT Part	-	-	2.9	$^\circ\text{C/W}$
	$R_{th(l-c)F}$	Inverter FWD	-	-	4.5	$^\circ\text{C/W}$
Contact Thermal Resistance	$R_{th(c-f)}$	Case to Fin, Thermal Grease Applied	-	-	0.4	$^\circ\text{C/W}$

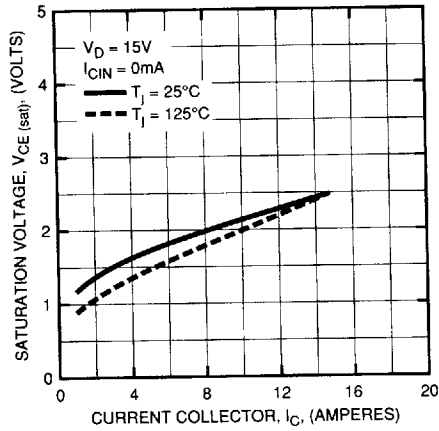
**Recommended Operating Conditions**

Characteristics	Symbol	Test Conditions	Value	Units
Supply Voltage	$V_{CC}$	Applied across P-N Terminals	0 ~ 400	Volts
	$V_D$	Applied between $V_{UP1} - V_{UPC}$ , $V_{N1} - V_{NC}$ , $V_{VP1} - V_{VPC}$ , $V_{WP1} - V_{WPC}$	$15 \pm 1.5$	Volts
Input On Current	$I_{CIN(on)}$	Applied between	0 ~ 0.5	mA
Input Off Current	$I_{CIN(off)}$	$U_P, V_P, W_P, U_N, V_N, W_N$	0.5 ~ 2	mA
PWM Input Frequency	$f_{PWM}$	Using example Interface Circuit*	5 ~ 20	kHz
Minimum Dead Time	$t_{DEAD}$	Using example Interface Circuit*	5.0	$\mu\text{S}$

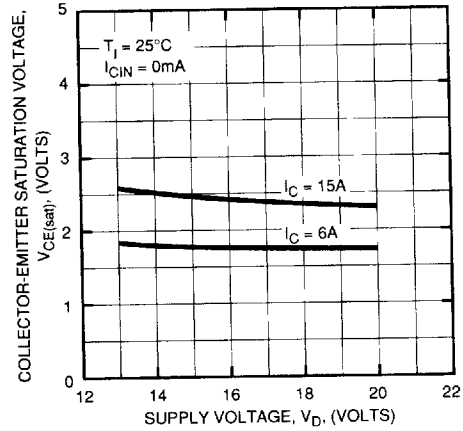
\*See Intellimod-3 Applications Data Section 4.3

**PM15CHA060**  
**Intellimod-3 Modules**  
**Three Phase IGBT Inverter Output**  
 15Amperes/110-230 Volt Line

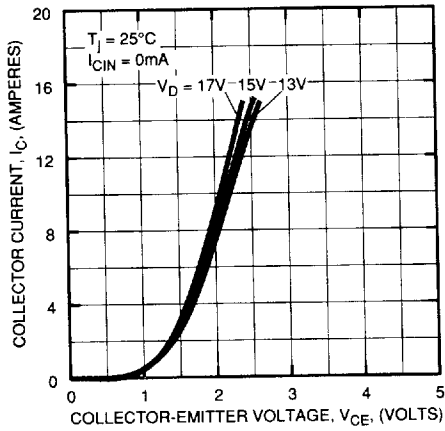
**SATURATION VOLTAGE CHARACTERISTICS (TYPICAL)**



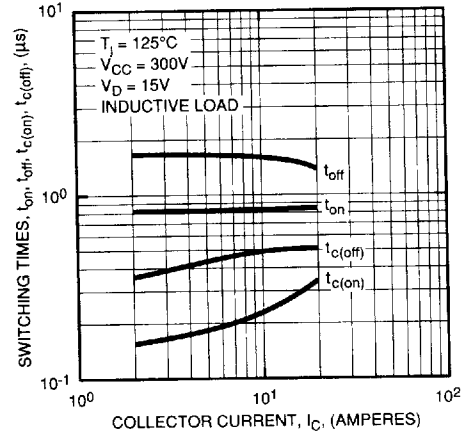
**COLLECTOR-EMITTER SATURATION VOLTAGE (TYPICAL)**



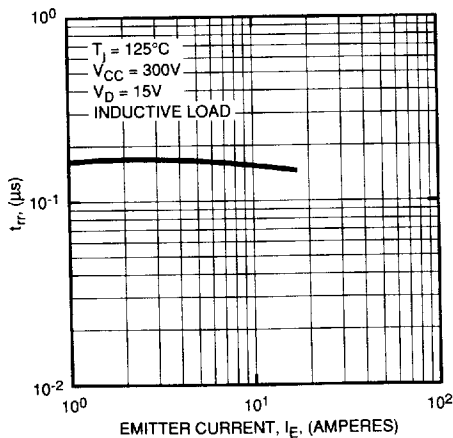
**OUTPUT CHARACTERISTICS (TYPICAL)**



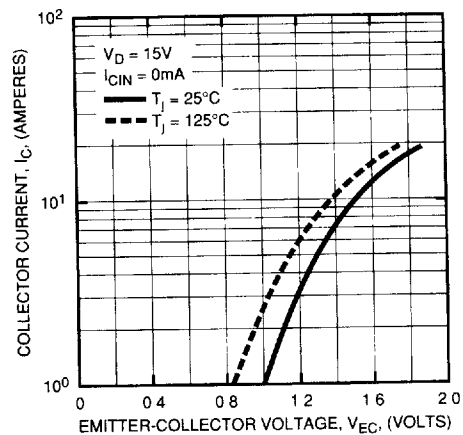
**SWITCHING TIME VS. COLLECTOR CURRENT (TYPICAL)**



**REVERSE RECOVERY CHARACTERISTICS OF FREE-WHEEL DIODE (TYPICAL)**



**REVERSE COLLECTOR CURRENT VS. EMITTER-COLLECTOR VOLTAGE (DIODE FORWARD CHARACTERISTICS) (TYPICAL)**

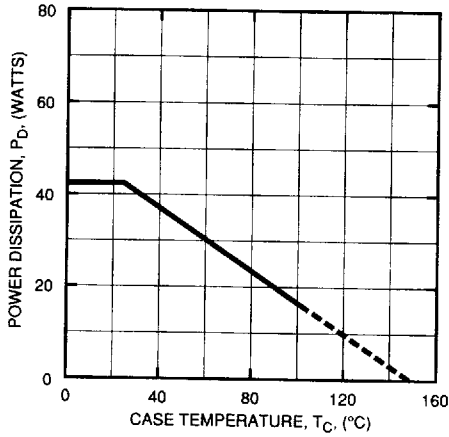


Powerex, Inc., Hillis Street, Youngwood, Pennsylvania 15697 (412) 925-7272  
 Powerex, Europe, S.A. 428 Avenue G. Durand, BP107, 72003 Le Mans, France (43) 41.14.14

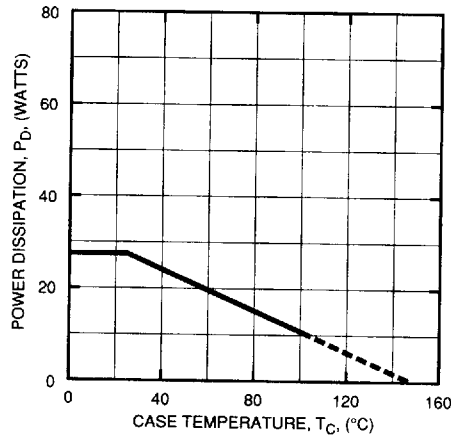
T-57-29

**PM15CHA060**  
**Intellimod-3 Modules**  
**Three Phase IGBT Inverter Output**  
 15 Amperes/110-230 Volt Line

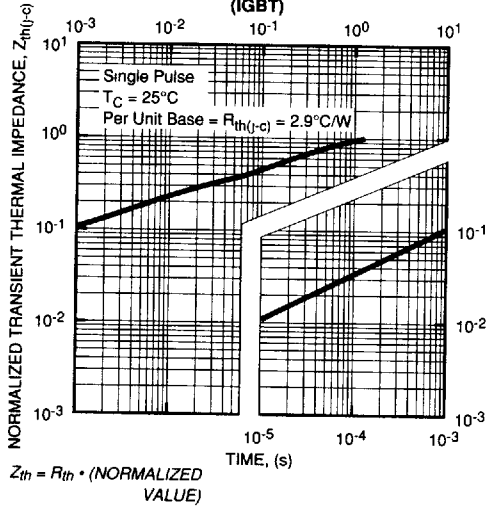
**POWER DISSIPATION DERATING CURVE  
 (PER IGBT ELEMENT)**



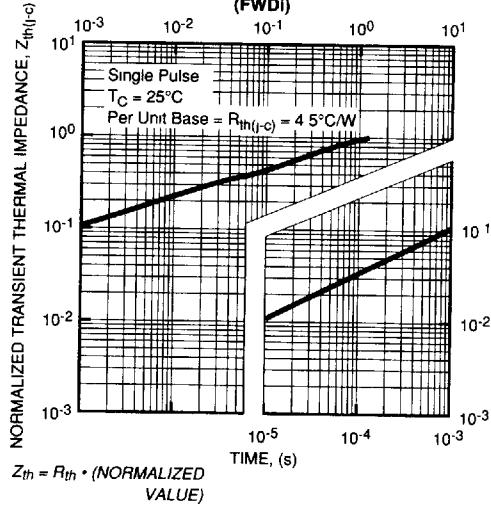
**POWER DISSIPATION DERATING CURVE  
 (PER FWDI ELEMENT)**



**TRANSIENT THERMAL IMPEDANCE CHARACTERISTICS  
 (IGBT)**

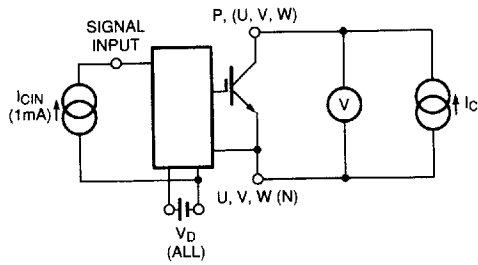


**TRANSIENT THERMAL IMPEDANCE CHARACTERISTICS  
 (FWDI)**

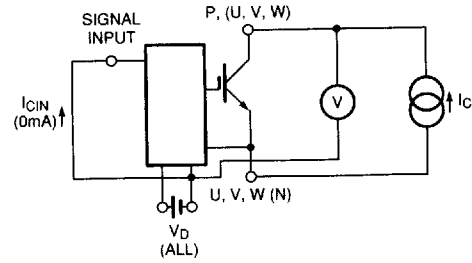


T-57-29

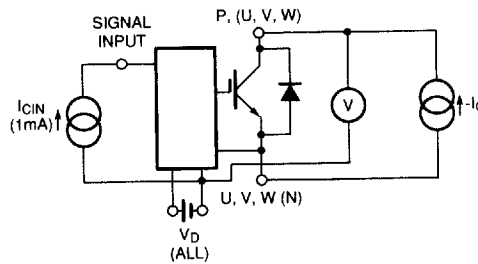
**PM15CHA060**  
**Intellimod-3 Modules**  
**Three Phase IGBT Inverter Output**  
 15 Amperes/110-230 Volt Line



**Figure 1  $V_{CES}$  Test**

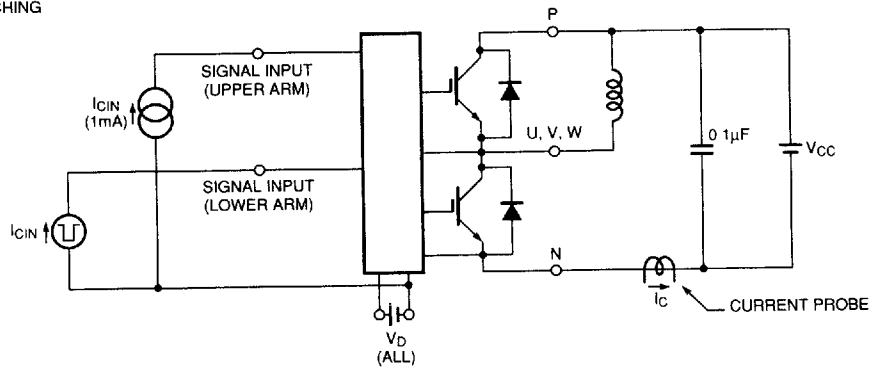


**Figure 2  $V_{CE(SAT)}$  Test**

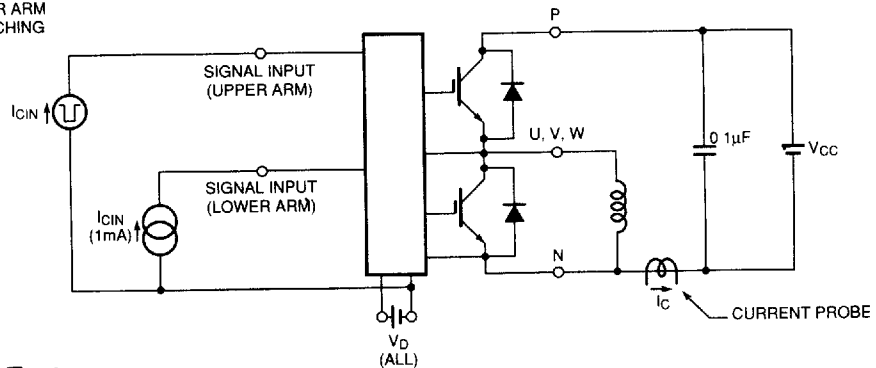


**Figure 3  $V_{EC}$  Test**

A) LOWER ARM SWITCHING

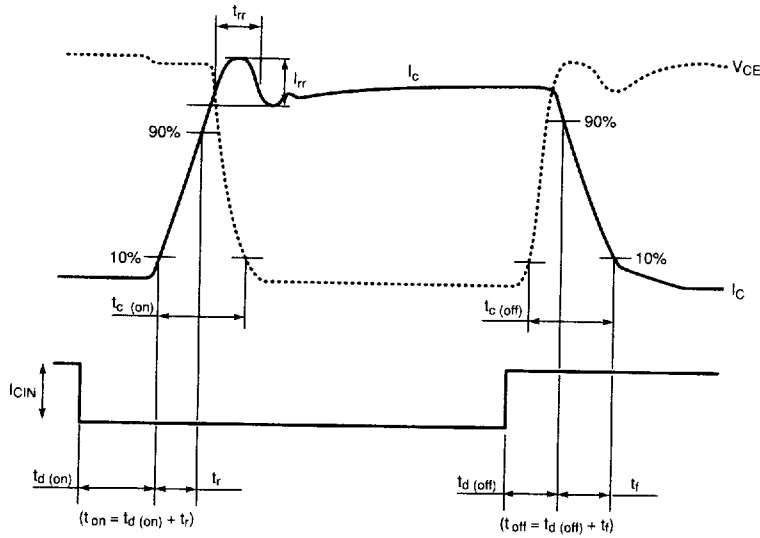


B) UPPER ARM SWITCHING

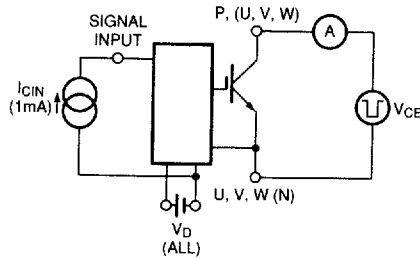


**Figure 4 Switching Time Test**

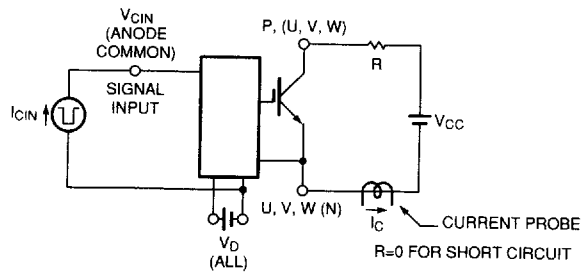
**PM15CHA060**  
**Intellimod-3 Modules**  
**Three Phase IGBT Inverter Output**  
 15 Amperes/110-230 Volt Line



**Figure 5 Switching Test Waveform**



**Figure 6  $I_{CES}$  Test**



**Figure 7 Over Current and Short Circuit Test**