

PACKAGE DIMENSIONS

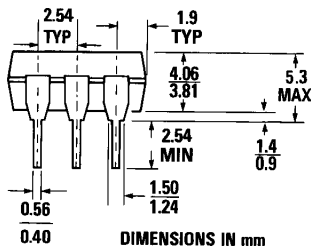

DIMENSIONS IN mm
PACKAGE CODE K

ST1603A

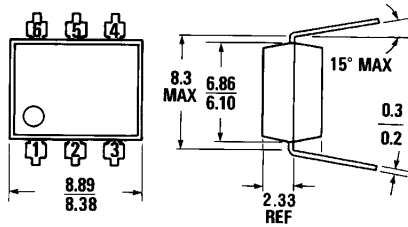
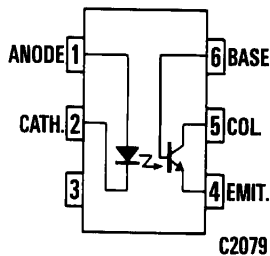

C2079

DESCRIPTION

The TIL111 is a phototransistor-type optically coupled isolator. An infrared emitting diode manufactured from specially grown gallium arsenide is selectively coupled with an NPN silicon phototransistor. The device is supplied in a standard plastic six-pin dual-in-line package.

FEATURES

- Underwriters Laboratory (UL) recognized File #E90700

APPLICATIONS

- Power supply regulators
- Digital logic inputs
- Microprocessor inputs
- Appliance sensor systems
- Industrial controls

ABSOLUTE MAXIMUM RATINGS (T_A=25°C Unless Otherwise Specified)

TOTAL PACKAGE

Storage temperature	-55°C to 150°C
Operating temperature	-55°C to 100°C
Lead temperature (soldering, 10 sec)	260°C
Total package power dissipation at 25°C (LED plus detector)	260 mW
Derate linearly from 25°C	3.3 mW/°C

INPUT DIODE

Forward DC current	100 mA
Reverse voltage	3 V
Peak forward current (1 μs pulse, 300 pps)	3.0 A
Power dissipation 25°C ambient	150 mW
Derate linearly from 25°C	2 mW/°C

OUTPUT TRANSISTOR

Power dissipation at 25°C	150 mW
Derate linearly from 25°C	2 mW/°C
V _{CEO}	30 V
V _{CBO}	70 V
V _{ECO}	7 V
Collector current (continuous)	100 mA

ELECTRICAL CHARACTERISTICS (At 25°C Free-Air Temperature)
INDIVIDUAL COMPONENT CHARACTERISTICS

PARAMETER	SYMBOL	TIL111			UNIT	TEST CONDITIONS
		MIN.	TYP.	MAX.		
INPUT DIODE Input diode static reverse current	I_R			10	μA	$V_R = 3\text{ V}$
Input diode static forward voltage	V_F		1.2	1.4	V	$I_F = 16\text{ mA}$
OUTPUT TRANSISTOR Collector-base breakdown voltage	$V_{(BR)CBO}$	70			V	$I_C = 10\ \mu\text{A}$, $I_E = 0$, $I_F = 0$
Collector-emitter breakdown voltage	$V_{(BR)CEO}$	30			V	$I_C = 1\text{ mA}$, $I_B = 0$, $I_F = 0$
Emitter-base breakdown voltage	$V_{(BR)EBO}$	7			V	$I_E = 10\ \mu\text{A}$, $I_C = 0$, $I_F = 0$
Transistor static forward current transfer ratio	h_{FE}	100	300			$V_{CE} = 5\text{ V}$, $I_C = 10\text{ mA}$, $I_F = 0$

TRANSFER CHARACTERISTICS

PARAMETER	SYMBOL	TIL111			UNIT	TEST CONDITIONS	
		MIN.	TYP.	MAX.			
On-state collector current	Phototransistor operation	$I_{C(on)}$	2	7	mA	$V_{CE} = 0.4\text{ V}$, $I_F = 16\text{ mA}$, $I_B = 0$	
	Photodiode operation	$I_{C(on)}$	7	20	μA	$V_{CB} = 0.4\text{ V}$, $I_C = 16\text{ mA}$, $I_E = 0$	
Off-state collector current	Phototransistor operation	$I_{C(off)}$		1	50	nA	$V_{CE} = 10\text{ V}$, $I_C = 0$, $I_B = 0$
	Photodiode operation	$I_{C(off)}$		0.1	20		$V_{CB} = 10\text{ V}$, $I_C = 0$, $I_E = 0$
Collector-emitter saturation voltage	$V_{CE(sat)}$		0.25	0.4	V	$I_C = 2\text{ mA}$, $I_F = 16\text{ mA}$, $I_B = 0$	

SWITCHING CHARACTERISTICS (At 25°C Free-Air Temperature)

PARAMETER	SYMBOL	TIL111			UNIT	TEST CONDITIONS
		MIN.	TYP.	MAX.		
Rise time	Phototransistor operation	t_r	5	10	μs	$V_{CC} = 10\text{ V}$, $I_{C(on)} = 2\text{ mA}$, $R_L = 100\ \Omega$
Fall time						
Rise time	Photodiode operation	t_r	1		μs	$V_{CC} = 10\text{ V}$, $I_{C(on)} = 20\ \mu\text{A}$, $R_L = 1\text{ k}\Omega$
Fall time						

ISOLATION CHARACTERISTICS

PARAMETER	SYMBOL	TIL111			UNIT	TEST CONDITIONS
		MIN.	TYP.	MAX.		
Input-to-output internal resistance	r_{io}	10^{11}			Ω	$V_{ISO} = \pm 1.5\text{ kV}$
Input-to-output capacitance	C_{io}		1	1.3	pF	$V_{in-out} = 0$, $f = 1\text{ MHz}$, See Note 6
Isolation voltage	V_{iso}		7500		VAC-PEAK	$I_{i.o} \leq 1\ \mu\text{A}$, 1 minute
			5300		VAC-RMS	$I_{i.o} \leq 1\ \mu\text{A}$, 1 minute

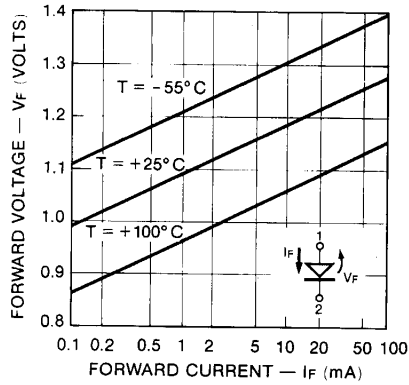

Fig. 1. Forward Voltage vs. Current

C1686

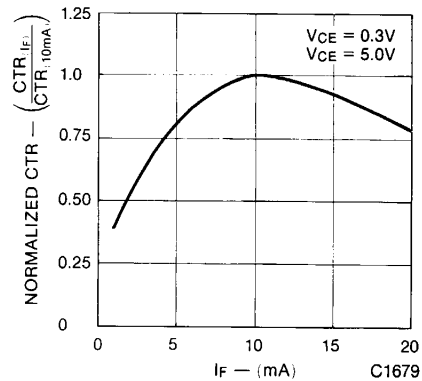

Fig. 2. Normalized CTR vs. Forward Current

C1679

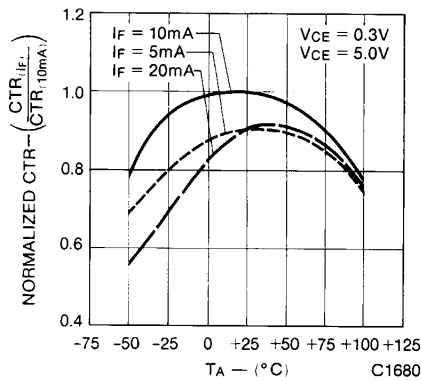

Fig. 3. Normalized CTR vs. Temperature

C1680

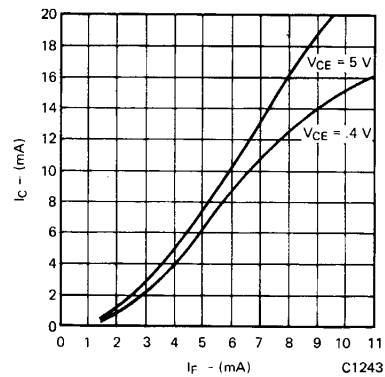

Fig. 4. Collector Current vs. Forward Current

C1243

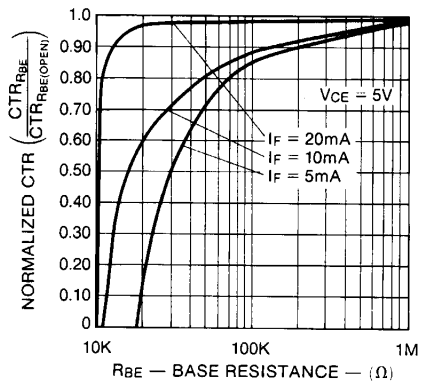

Fig. 5. CTR vs. R_{BE} (Unsaturated)

C1681

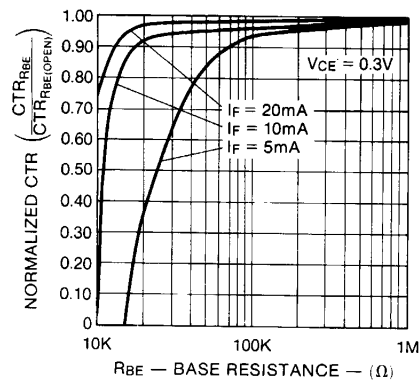
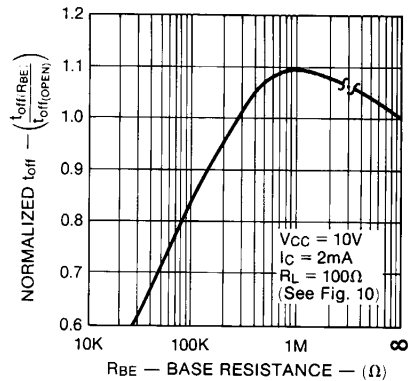

Fig. 6. CTR vs. R_{BE} (Saturated)

C1682



C1683

Fig. 7. Normalized T_{OFF} vs. R_{BE}

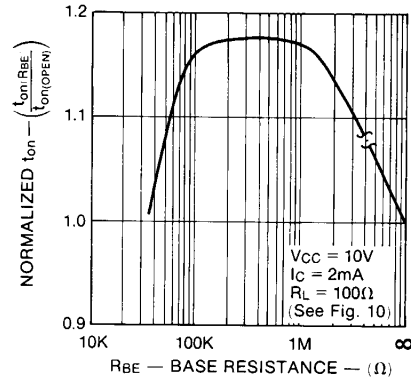

C1684

Fig. 8. Normalized T_{ON} vs. R_{BE}

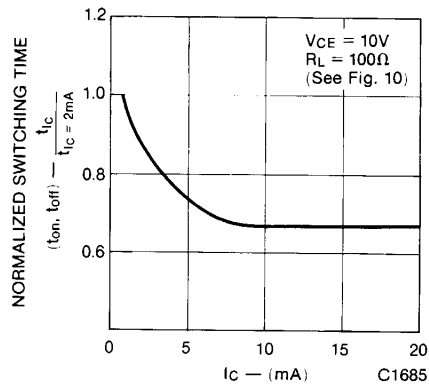

C1685

Fig. 9. Switching Time vs. I_C

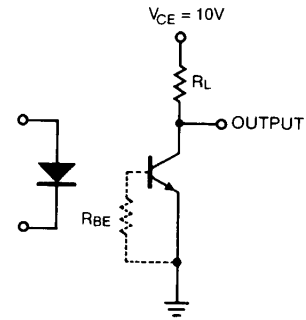

C1296A

Fig. 10. Switching Time Test Circuit

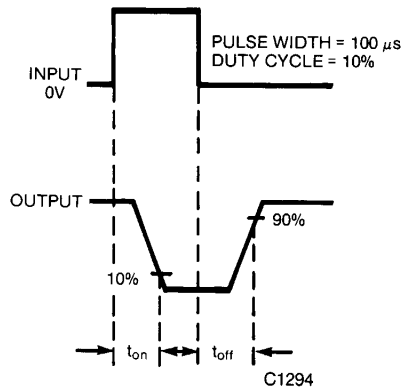

C1294

Fig. 11. Switching Time Waveforms