

PACKAGE DIMENSIONS

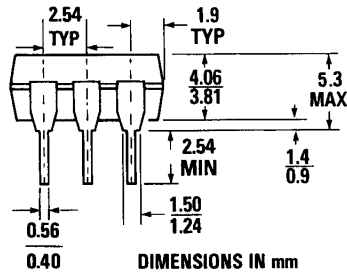

DIMENSIONS IN mm
PACKAGE CODE K

ST1603A

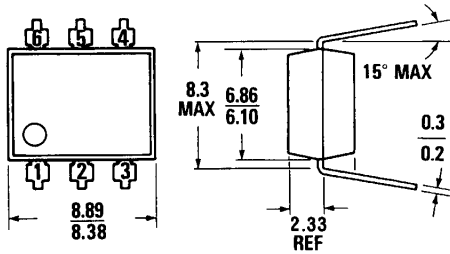
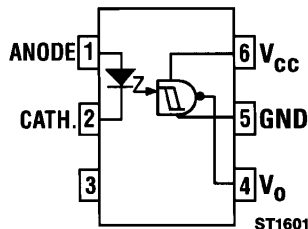

Equivalent Circuit

DESCRIPTION

The H11L series has a medium-to-high speed integrated circuit detector optically coupled to a gallium-arsenide infrared emitting diode. The output incorporates a Schmitt trigger, which provides hysteresis for noise immunity and pulse shaping. The detector circuit is optimized for simplicity of operation and utilizes an open collector output for maximum application flexibility.

FEATURES

- High data rate, 1 MHz typical (NRZ)
- Free from latch up and oscillation throughout voltage and temperature ranges.
- Microprocessor compatible drive
- Logic compatible output sinks 16 mA at 0.4 V maximum
- Guaranteed on/off threshold hysteresis
- High common mode rejection ratio
- Fast switching: $t_r, t_f=100$ ns typical
- Wide supply voltage capability, compatible with all popular logic systems
- Underwriters Laboratory (UL) recognized — file #E90700

APPLICATIONS

- Logic to logic isolator
- Programmable current level sensor
- Line receiver—eliminate noise and transient problems
- A.C. to TTL conversion—square wave shaping
- Digital programming of power supplies
- Interfaces computers with peripherals

ABSOLUTE MAXIMUM RATINGS

TOTAL PACKAGE

Storage temperature -55°C to 150°C
 Operating temperature -55°C to 100°C
 Lead solder temperature 260°C for 10 sec

INPUT DIODE

Power dissipation (25°C ambient) 100 mW
 Derate linearly (above 25°C ambient) 1.33 mW/ $^{\circ}\text{C}$
 Continuous forward current 60 mA
 Peak forward current ($1\ \mu\text{s}$ pulse, 300pps) 3 A
 Reverse voltage 6 V

DETECTOR

Power dissipation (at 25°C ambient) 150 mW
 Derate linearly (above 25°C ambient) 2 mW/ $^{\circ}\text{C}$
 V_{45} allowed range 0 to 16 V
 V_{65} allowed range 0 to 16 V
 I_o output current 50 mA



MICROPROCESSOR COMPATIBLE GaAs SCHMITT TRIGGER OPTOCOUPLERS

ELECTRICAL CHARACTERISTICS ($T_A = 0-70^\circ\text{C}$ Unless Otherwise Specified)

INDIVIDUAL COMPONENT CHARACTERISTICS

PARAMETER	SYMBOL	MIN.	TYP.	MAX.	UNITS	TEST CONDITIONS
INPUT DIODE						
Forward voltage	V_F		1.1	1.5	V	$I_f = 10 \text{ mA}$
	V_F	0.75	0.95		V	$I_f = 0.3 \text{ mA}$
Reverse current	I_R			10	μA	$V_R = 3 \text{ V}$
Capacitance	C_J			100	pF	$V = 0, f = 1 \text{ MHz}$
OUTPUT DETECTOR						
Operating voltage range	V_{CC}	3		15	V	
Supply current	$I_{c(off)}$		1.0	5.0	mA	$I_e = 0, V_{CC} = 5 \text{ V}$
Output current, high	I_{OH}			100	μA	$I_e = 0, V_{CC} = V_O = 15 \text{ V}$

TRANSFER CHARACTERISTICS

CHARACTERISTIC	SYMBOL	MIN.	TYP.	MAX.	UNITS	TEST CONDITIONS
Supply current	$I_{e(on)}$		1.6	5	mA	$I_f = 10 \text{ mA}, V_{CC} = 5 \text{ V}$
Output voltage, low	V_{OL}		0.2	0.4	V	$R_L = 270 \Omega, V_{CC} = 5 \text{ V}, I_e = I_{F(on)} \text{ max.}$
Turn-on threshold current	(H11L1) $I_{F(on)}$		1.0	1.6	mA	$R_L = 270 \Omega, V_{CC} = 5 \text{ V}$
	(H11L2) $I_{F(on)}$		6.0	10.0	mA	$R_L = 270 \Omega, V_{CC} = 5 \text{ V}$
	(H11L3) $I_{F(on)}$		3.0	5.0	mA	$R_L = 270 \Omega, V_{CC} = 5 \text{ V}$
Turn-off threshold current	$I_{F(off)}$	0.3	1.0		mA	$R_L = 270 \Omega, V_{CC} = 5 \text{ V}$
Hysteresis ratio	$I_{F(off)}/I_{F(on)}$	0.50	0.75	0.90		$R_L = 270 \Omega, V_{CC} = 5 \text{ V}$



MICROPROCESSOR COMPATIBLE GaAs SCHMITT TRIGGER OPTOCOUPLERS

DYNAMIC CHARACTERISTICS						
PARAMETER	SYMBOL	MIN.	TYP.	MAX.	UNITS	TEST CONDITIONS
SWITCHING SPEED						
Turn-on time	t_{ON}		1.0		μS	$C=0, R_E=1.2\ k\Omega$
	t_{ON}		0.65		μS	$C=270\ pF, R_E=1.2\ k\Omega$ $f \leq 100\ KHz, t_p \geq 1\ \mu s$
Fall time	t_f		0.1		μS	$C=0, R_E=1.2\ k\Omega$
	t_f		0.05		μS	$C=270\ pF, R_E=1.2\ k\Omega$ $f \leq 100\ KHz, t_p \geq 1\ \mu s$
Turn-off time	t_{OFF}		2.0		μS	$C=0, R_E=1.2\ k\Omega$
	t_{OFF}		1.20		μS	$C=270\ pF, R_E=1.2\ k\Omega$ $f \leq 100\ KHz, t_p \geq 1\ \mu s$
Rise time	t_r		0.1		μS	$C=0, R_E=1.2\ k\Omega$
	t_r		0.07		μS	$C=270\ pF, R_E=1.2\ k\Omega$ $f \leq 100\ KHz, t_p \geq 1\ \mu s$
Data rate			1.0*		MHz	

ISOLATION CHARACTERISTICS						
CHARACTERISTIC	SYMBOL	MIN.	TYP.	MAX.	UNITS	TEST CONDITIONS
Surge isolation voltage	V_{ISO}	7500			V_{PEAK}	1 Minute
Surge isolation voltage	V_{ISO}	5300			V_{RMS}	1 Minute

*Maximum data rate will vary depending on the bias conditions and is usually highest when R_E and C are matched to $I_{F(ON)}$ and V_{CC} is between 3 and 15 V. With this optimized bias, most units will operate over 1.5 MHz (NRZ).

SWITCHING CHARACTERISTICS (25°C) H11L1

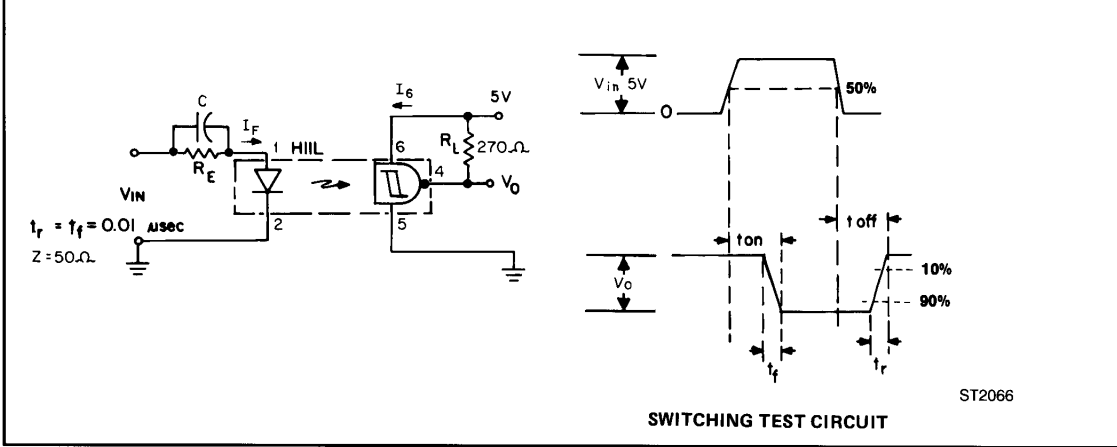

SWITCHING TEST CIRCUIT

TYPICAL CHARACTERISTICS

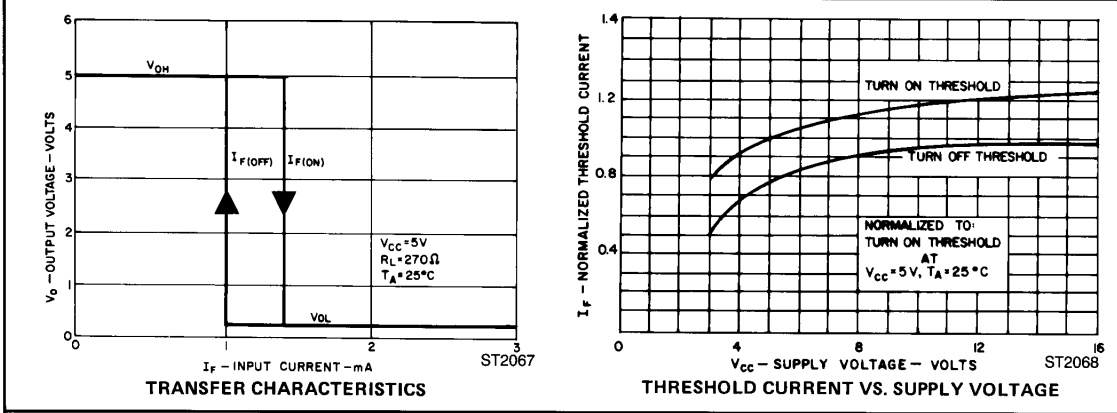

TRANSFER CHARACTERISTICS

THRESHOLD CURRENT VS. SUPPLY VOLTAGE

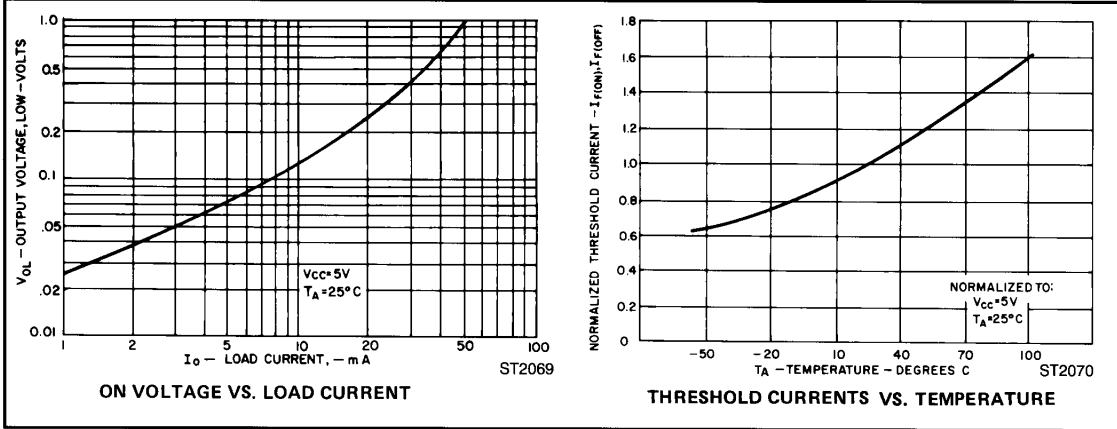

ON VOLTAGE VS. LOAD CURRENT

THRESHOLD CURRENTS VS. TEMPERATURE

TYPICAL CHARACTERISTICS (Cont'd)

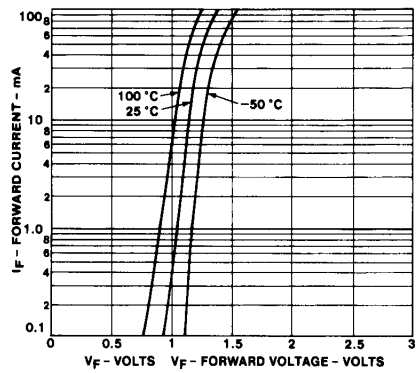

ST2015

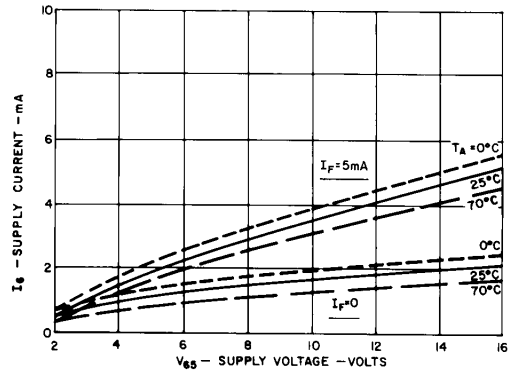

ST2016

FORWARD VOLTAGE VS. FORWARD CURRENT

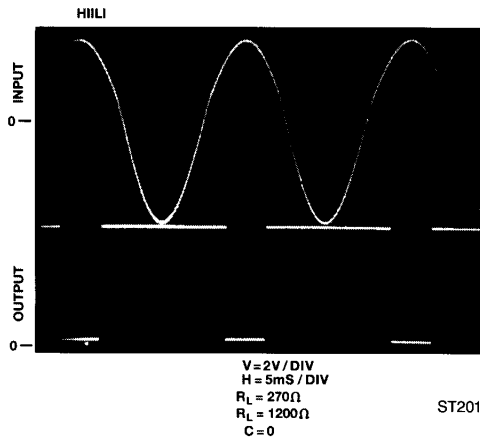

ST2017

SUPPLY CURRENT VS. SUPPLY VOLTAGE

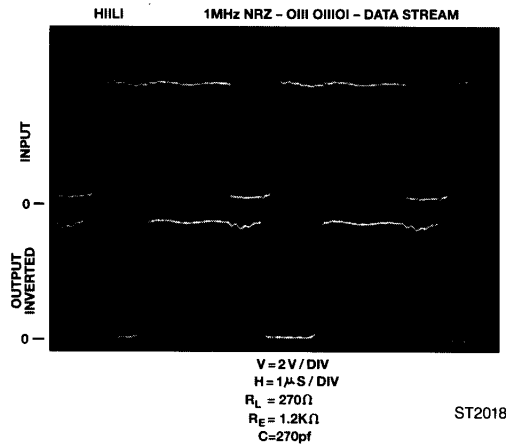

ST2018



MICROPROCESSOR COMPATIBLE GaAs SCHMITT TRIGGER OPTOCOUPLERS

TYPICAL APPLICATION

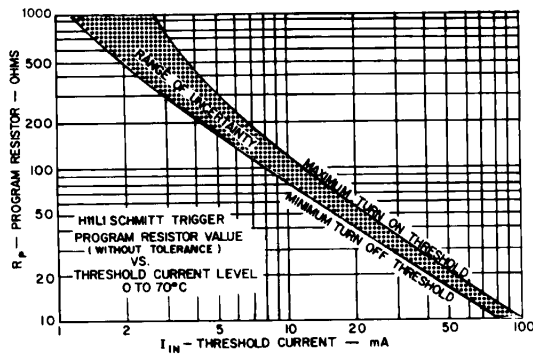

ST2019

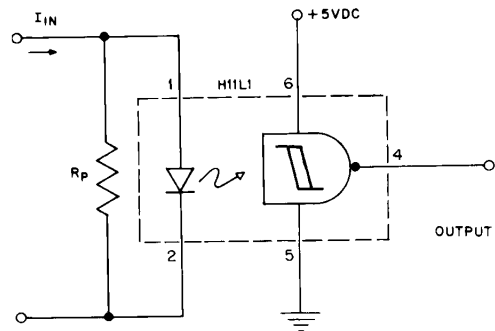

PROGRAMMABLE CURRENT THRESHOLD SENSING CIRCUIT