

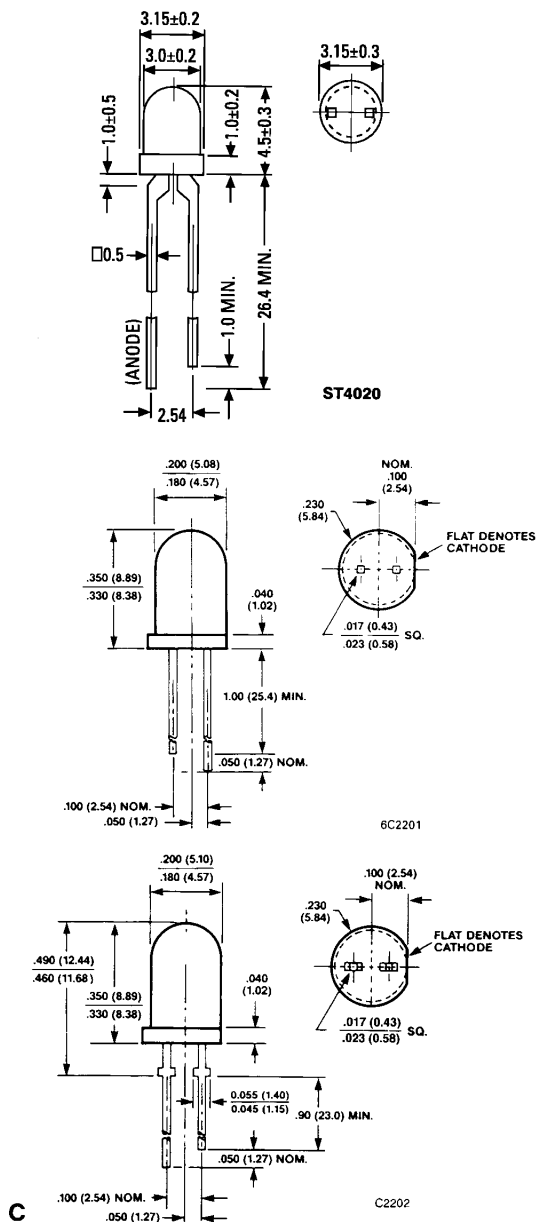

DOUBLE HETEROJUNCTION AlGaAs LOW CURRENT RED LED LAMPS

T-1^{3/4} HLMP-D150A/D155A
T-1 HLMP-K150/K155

PACKAGE DIMENSIONS



1. ALL DIMENSIONS ARE IN INCHES (mm)
2. TOLERANCES ARE ± 0.010 " UNLESS OTHERWISE SPECIFIED
3. AN EPOXY MENISCUS MAY EXTEND ABOUT .040" (1 mm) DOWN THE LEADS

DESCRIPTION

A recently developed double heterojunction (DH) AlGaAs/GaAs material technology is the basis of the light emitting chip utilized in these solid state lamps. Exceptional light output typifies these devices and provides for their use over a broad range of drive currents. At a dominant wavelength of 637 nanometers, the light is perceived as a deep red color. These lamps are ideally suited for use in applications where high light output is required with minimum power input.

FEATURES

- Luminous intensity specified at 1 mA
- High light output at low currents
- Wide viewing angle
- Low power/low forward voltage
- Outstanding material efficiency
- CMOS/MOS compatible
- TTL compatible
- Deep red color

APPLICATIONS

- Low power circuits
- Battery powered equipment
- Telecommunication indicators



DOUBLE HETEROJUNCTION AlGaAs LOW CURRENT RED LED LAMPS

PHYSICAL CHARACTERISTICS

SIZE	TYPE	LENS EFFECT	I_v (mcd) MIN.	@ 1mA TYP.	VIEWING ANGLE 2 θ 1/2 DEGREES	PKG.
T-1	HLMP-K150	Red Tinted Diffused	1.2	2	60	A
T-1	HLMP-K155	Clear	2	3	45	A
T-1 $\frac{1}{4}$	HLMP-D150A	Red Tinted Diffused	1.2	3	65	B
T-1 $\frac{1}{4}$	HLMP-D155A	Clear	5	10	24	C

ELECTRO-OPTICAL CHARACTERISTICS ($T_A = 25^\circ\text{C}$ Unless Otherwise Specified)

PARAMETER	SYMBOL	MIN.	TYP.	MAX.	UNITS	TEST CONDITIONS
Forward voltage	V_f		1.6	1.8	V	$I_f = 1 \text{ mA}$
Peak wavelength	λ_p		645		nm	$I_f = 1 \text{ mA}$
Dominant wavelength	λ_d		637		nm	$I_f = 1 \text{ mA}$
Spectral line half width	$\Delta\lambda_{1/2}$		20		nm	$I_f = 1 \text{ mA}$
Capacitance	C		30		pF	$V_r = 0, f = 1 \text{ MHz}$
Reverse breakdown voltage	V_R	5.0	15.0		V	$I_R = 100 \mu\text{A}$

ABSOLUTE MAXIMUM RATINGS ($T_A = 25^\circ\text{C}$ Unless Otherwise Specified)

Power dissipation	87 mW
Operating temperature	-20°C to +100°C
Storage temperature	-55°C to +100°C
Lead soldering time at 260°C	5 seconds
Peak forward current (see Note 1)	300 mA
Reverse voltage ($I_R = 100 \mu\text{A}$)	5V
Average forward current (see Note 2)	20 mA

NOTES

1. Maximum I_{peak} at $f = 1 \text{ kHz}$, $DF = 6.7\%$
2. Derate linearly as shown in Figure 4.

TYPICAL ELECTRO-OPTICAL CHARACTERISTIC CURVES
(25°C Free Air Temperature)

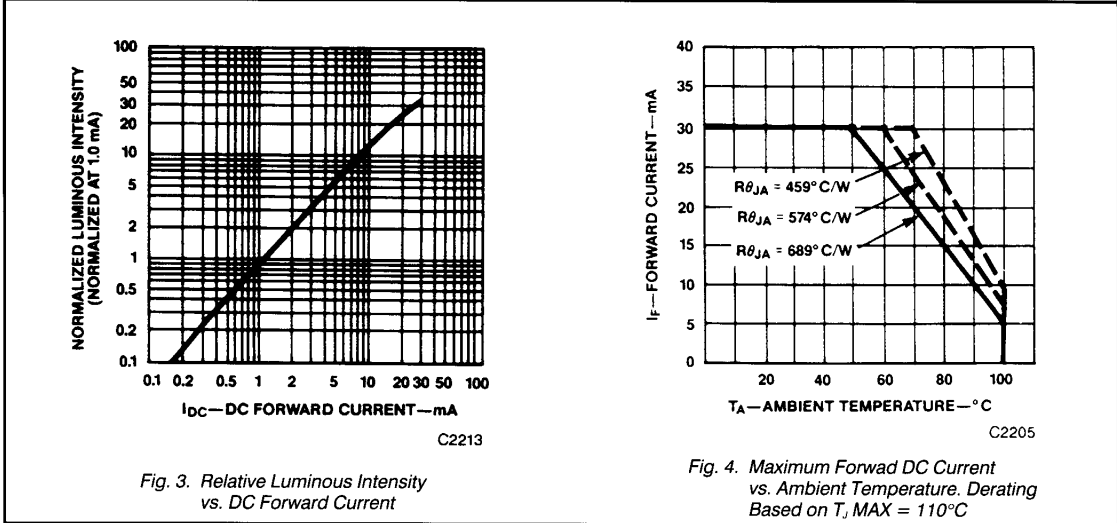
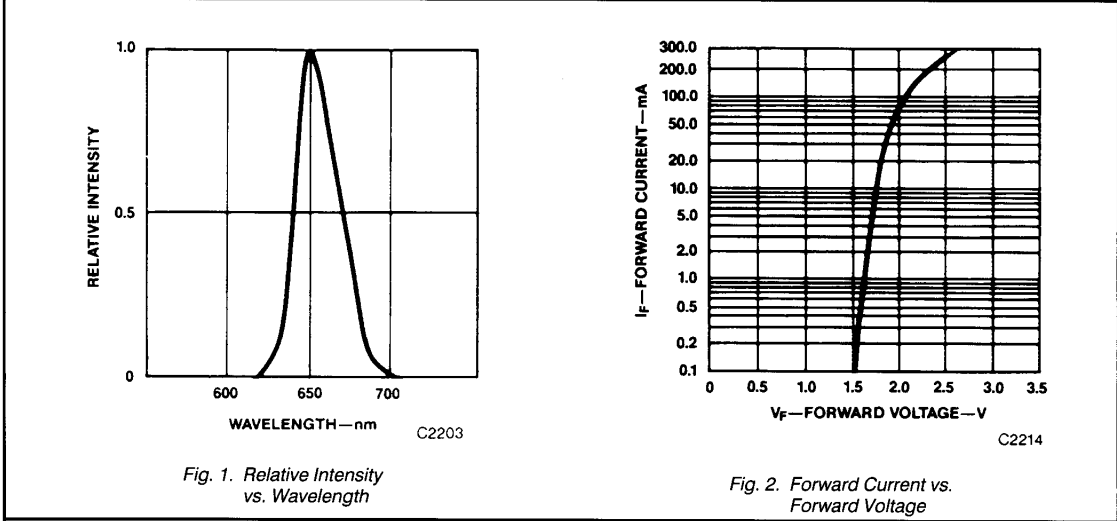

TYPICAL ELECTRO-OPTICAL CHARACTERISTIC CURVES
(25°C Free Air Temperature) (Cont'd)

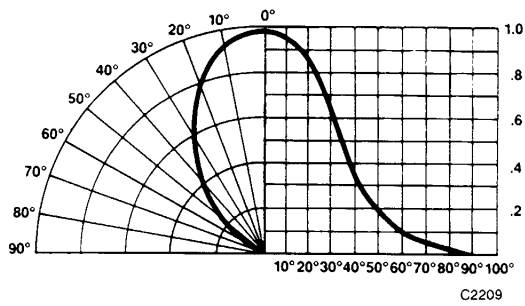

Fig. 5. Relative Luminous Intensity vs. Angular Displacement. HLMP-D150A

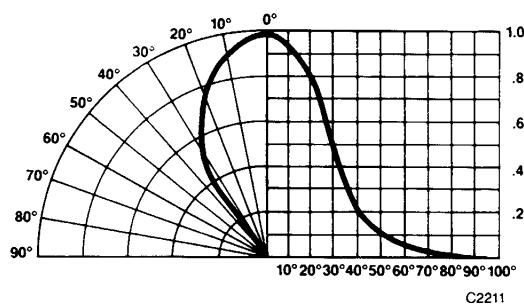

Fig. 6. Relative Luminous Intensity vs. Angular Displacement. HLMP-K150

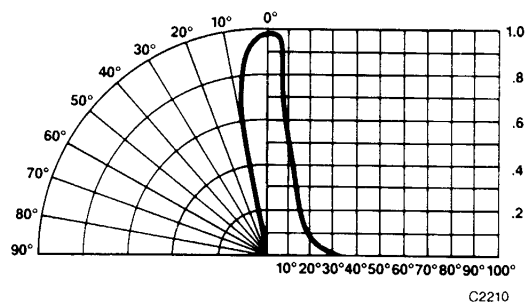

Fig. 7. Relative Luminous Intensity vs. Angular Displacement. HLMP-D155A

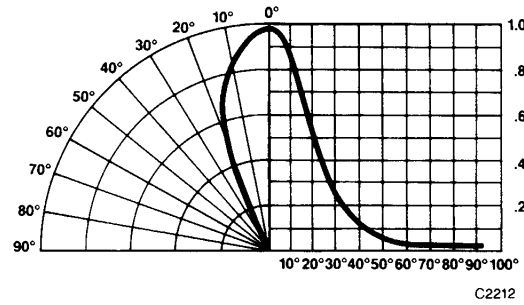

Fig. 8. Relative Luminous Intensity vs. Angular Displacement. HLMP-K155