

GLASS PASSIVATED SUPER FAST RECTIFIER

VOLTAGE RANGE 50 to 400 Volts CURRENT 5.0 Amperes

FEATURES

- * High reliability
- * Low leakage
- * Low forward voltage
- * High current capability
- * Super fast switching speed
- * High surge capability
- * Good for switching mode circuit

MECHANICAL DATA

- * Case: Molded plastic
- * Epoxy: Device has UL flammability classification 94V-0
- * Lead: MIL-STD-202E method 208C guaranteed
- * Mounting position: Any
- * Weight: 1.18 grams

MAXIMUM RATINGS AND ELECTRICAL CHARACTERISTICS

Ratings at 25 °C ambient temperature unless otherwise specified.
Single phase, half wave, 60 Hz, resistive or inductive load.
For capacitive load, derate current by 20%.

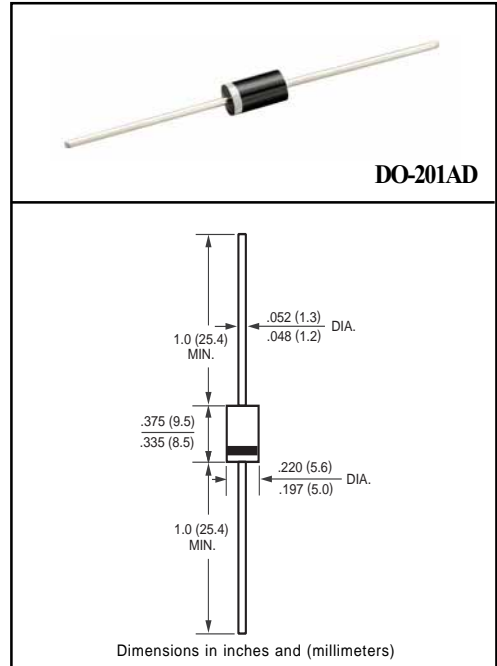

MAXIMUM RATINGS (At TA = 25°C unless otherwise noted)

RATINGS	SYMBOL	SF51	SF52	SF53	SF54	SF55	SF56	UNITS
Maximum Recurrent Peak Reverse Voltage	V _{RRM}	50	100	150	200	300	400	Volts
Maximum RMS Volts	V _{RMS}	35	70	105	140	210	280	Volts
Maximum DC Blocking Voltage	V _{DC}	50	100	150	200	300	400	Volts
Maximum Average Forward Current at TA = 55°C	I _O	5.0						Amps
Peak Forward Surge Current I _{FM} (surge): 8.3 ms single half sine-wave superimposed on rated load (JEDEC method)	I _{FSM}	150						Amps
Typical Junction Capacitance (Note 2)	C _J	50				30		pF
Operating and Storage Temperature Range	T _J , T _{STG}	-65 to +150						°C

ELECTRICAL CHARACTERISTICS (At TA = 25°C unless otherwise noted)

CHARACTERISTICS	SYMBOL	SF51	SF52	SF53	SF54	SF55	SF56	UNITS
Maximum DC Reverse Current at Rated DC Blocking Voltage	@ TA = 25°C	5.0						uAmps
	@ TA = 125°C	150						
Maximum Forward Voltage at 5.0A DC	V _F	0.95				1.25		Volts
Maximum Reverse Recovery Time (Note 1)	t _{rr}	35						nSec

NOTES : 1. Test Conditions: I_F=0.5A, I_R=-1.0A, I_{RR}=-0.25A.
2. Measured at 1 MHz and applied reverse voltage of 4.0 volts.

RATING AND CHARACTERISTIC CURVES (SF51 THRU SF56)

FIG. 1 - TEST CIRCUIT DIAGRAM AND REVERSE RECOVERY TIME CHARACTERISTIC

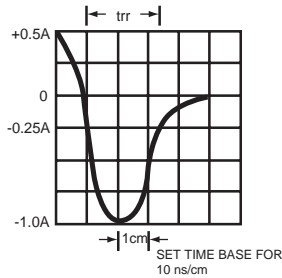
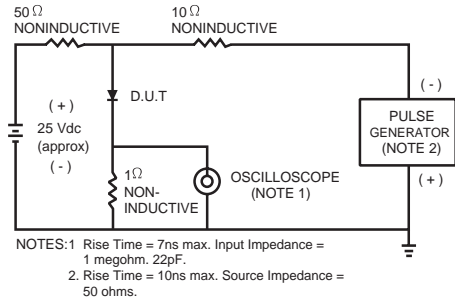

FIG. 2 - TYPICAL FORWARD CURRENT DERATING CURVE

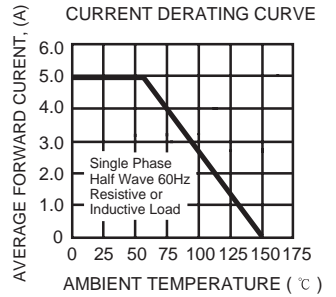

FIG. 3 - TYPICAL REVERSE CHARACTERISTICS

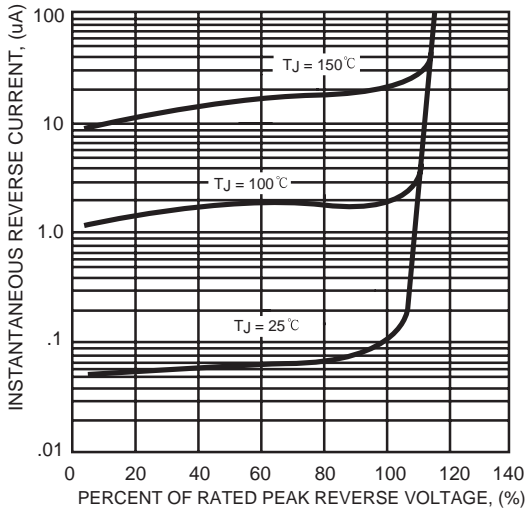

FIG. 4 - TYPICAL INSTANTANEOUS FORWARD CHARACTERISTICS

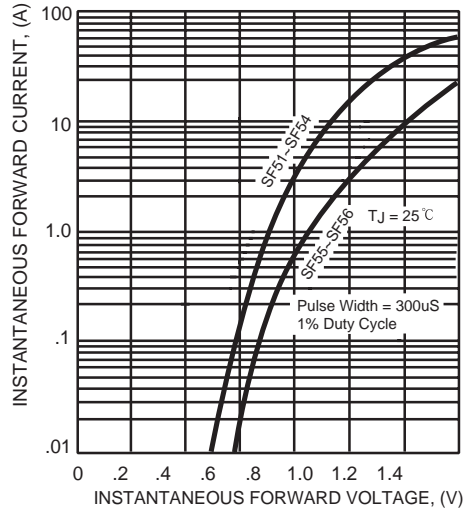

FIG. 5 - MAXIMUM NON-REPETITIVE FORWARD SURGE CURRENT

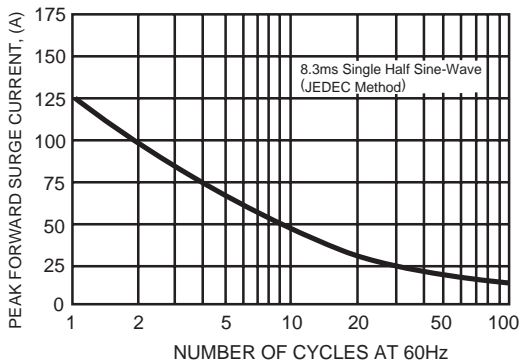

FIG. 6 - TYPICAL JUNCTION CAPACITANCE

