

Typical Applications

- WLAN or Wireless Local Loop
- Digital Communication Systems
- Spread-Spectrum Communication Systems
- Part of 2.4GHz Chipset
- Portable Battery-Powered Equipment
- UHF Digital and Analog Receivers

Product Description

The RF2444 is a monolithic integrated UHF receiver front end suitable for 2.4GHz ISM band applications. The IC contains all of the required components to implement the RF functions of the receiver except for the passive filtering and LO generation. It contains an LNA (low-noise amplifier), a second RF amplifier and a doubly balanced mixer. The output of the LNA is made available as an output to permit the insertion of a bandpass filter between the LNA and the RF/Mixer section. The mixer outputs can be selectively disabled to allow for the IF filter to be used in the transmit mode.

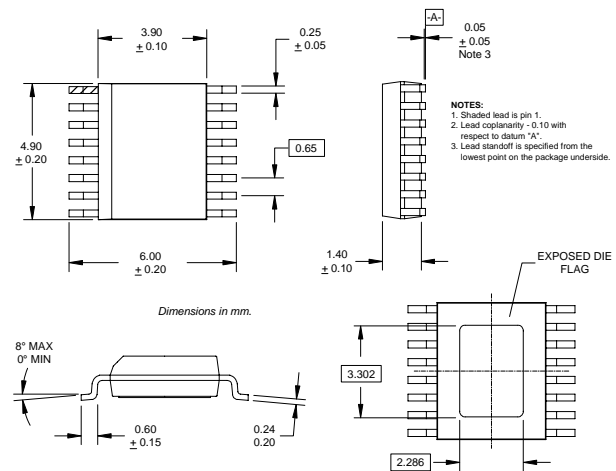

Optimum Technology Matching® Applied

- Si BJT
- GaAs HBT
- GaAs MESFET
- Si Bi-CMOS
- SiGe HBT
- Si CMOS

Package Style: SSOP-16 EDF Slug

Features

- Single 2.7V to 3.6V Power Supply
- 2400MHz to 2500MHz Operation
- Two Gain Settings: 28dB or 12dB
- 4.5dB Cascaded NF, High Gain Mode
- 20mA DC Current Consumption
- Input IP₃: -23dBm or -8dBm

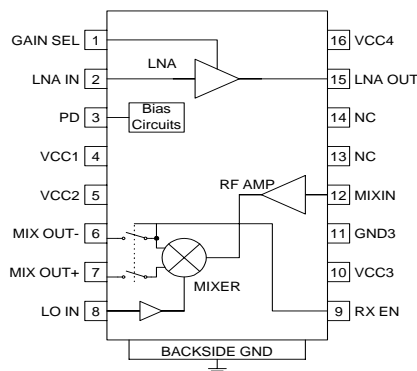

Functional Block Diagram

Ordering Information

RF2444 High Frequency LNA/Mixer
RF2444 PCBA-H Fully Assembled Evaluation Board (2.5GHz)

RF Micro Devices, Inc.
7625 Thorndike Road
Greensboro, NC 27409, USA

Tel (336) 664 1233
Fax (336) 664 0454
<http://www.rfmd.com>

RF2444

Absolute Maximum Ratings

Parameter	Rating	Unit
Supply Voltage	-0.5 to 3.6	V _{DC}
Input LO and RF Levels	+6	dBm
Operating Ambient Temperature	-40 to +85	°C
Storage Temperature	-40 to +150	°C
Moisture Sensitivity	JEDEC Level 5 @ 220°C	

Refer to "Handling of PSOP and PSSOP Products" on page 16-15 for special handling information.



Caution! ESD sensitive device.

RF Micro Devices believes the furnished information is correct and accurate at the time of this printing. However, RF Micro Devices reserves the right to make changes to its products without notice. RF Micro Devices does not assume responsibility for the use of the described product(s).

Parameter	Specification			Unit	Condition
	Min.	Typ.	Max.		
Overall					T = 25°C, V _{CC} = 3.3V, RF = 2400 MHz, LO = 2120 MHz, -1.0 dBm
RF Frequency Range		2400 to 2500		MHz	
IF Frequency Range	10	280	500	MHz	
Cascade Gain		28		dB	IF = 280 MHz, GAIN SEL = 1
		12		dB	IF = 280 MHz, GAIN SEL = 0
Cascade IP3		-23		dBm	Referenced to the input, GAIN SEL = 1
		-8		dBm	Referenced to the input, GAIN SEL = 0
Cascade Noise Figure		4.5		dB	Single sideband, GAIN SEL = 1
		18		dB	Single sideband, GAIN SEL = 0
Input P1dB		-28		dBm	GAIN SEL = 1
		-14		dBm	GAIN SEL = 0
LNA					
Noise Figure		2.3		dB	GAIN SEL = 1
		7		dB	GAIN SEL = 0
Input VSWR			2:1		No external matching
Input IP3		-3		dBm	GAIN SEL = 1
		-3		dBm	GAIN SEL = 0
Gain		10		dB	GAIN SEL = 1
		-6		dB	GAIN SEL = 0
Reverse Isolation		22		dB	
Output Impedance		50		Ω	
RF Amp and Mixer					
Noise Figure		10		dB	Single sideband
Input Impedance		50		Ω	
Input IP3		-17		dBm	
Conversion Power Gain		18		dB	With Current Combiner (1 kΩ between open collectors and 250 Ω single ended load)
Output Impedance		4		kΩ	Open Collector
LO Input					
LO Level	-15	-10	0	dBm	
LO to RF Rejection		42		dB	LO input to LNA input
LO to IF Rejection		15		dB	LO input to IF output
LO Input VSWR			2:1		
Power Down Control					
Logic Controls "ON"	V _{CC} -0.3			V	Voltage at the input of RX EN, PD and GAIN SEL
Logic Controls "OFF"			300	mV	
Turn on Time		400	1000	nS	From PD Going high.
Turn on Time		100	200	nS	From RX EN Going high. PD = "1"

8

FRONT-ENDS

Parameter	Specification			Unit	Condition
	Min.	Typ.	Max.		
Power Supply					
Voltage	2.7	3.3	3.6	V	GAIN SEL = 1, RX EN =1, PD = 1 GAIN SEL = 0, RX EN =1, PD = 1 GAIN SEL = X, RX EN =0, PD = 1 GAIN SEL = X, RX EN =X, PD = 0
Current Consumption		20	26	mA	
		20	25	mA	
		12	16	mA	
			1	μA	

RF2444

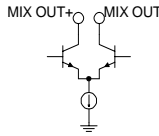
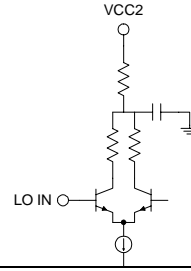
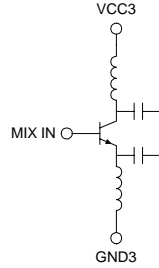
Pin	Function	Description	Interface Schematic
1	GAIN SEL	LNA gain control. When GAIN SEL is $>V_{CC} - 300\text{mV}$, LNA gain is at 10 dB. When GAIN SEL is $<300\text{mV}$, the LNA gain is -6dB.	See pin 16.
2	LNA IN	This pin is NOT internally DC blocked. An external blocking capacitor must be provided if the pin is connected to a device with DC present. If a blocking capacitor is required, a value of 2pF is recommended.	See pin 16.
3	PD	The power enable pin. When PD is $>V_{CC} - 300\text{mV}$, the part is biased on. When PD is $<300\text{mV}$, then the part is turned off and typically draws less than 1 μA .	
4	VCC1	Supply voltage for bias circuits and logic control. A 10pF external bypass capacitor is required and an additional 0.01 μF is required if no other low frequency bypass capacitors are nearby. The trace length between the pin and the bypass capacitors should be minimized. The ground side of the bypass capacitors should connect immediately to ground plane.	
5	VCC2	Supply voltage for LO_Buffer. A 10pF bypass capacitor is required and an additional 0.01 μF is required if there is no other low frequency bypass capacitor in the area. The trace length between the pin and the bypass capacitors should be minimized. The ground side of the bypass capacitors should connect immediately to ground plane.	See pin 8.
6	MIXOUT-	The inverting open collector output of the mixer. This pin needs to be externally biased and DC isolated from other parts of the circuit. This output can drive a Balun, with MIXOUT+, to convert to unbalanced to drive a SAW filter. The Balun can be either broadband (transformer) or narrowband (discrete LC matching). Alternatively, MIXOUT+ may be used alone to drive a SAW single-ended, with an RF choke (high Z at IF) from VCC to MIXOUT-.	
7	MIXOUT+	The non-inverting open collector output of the mixer. This pin needs to be externally biased and DC isolated from other parts of the circuit. This output can drive a Balun, with MIXOUT-, to convert to unbalanced to drive a SAW filter. The Balun can be either broadband (transformer) or narrowband (discrete LC matching). Alternatively, MIXOUT+ may be used alone to drive a SAW single-ended, with an RF choke (high Z at IF) from VCC to MIXOUT+.	See pin 6.
8	LO IN	LO input pin. This input needs a DC blocking cap. External matching is recommended to 50 Ω .	
9	RX EN	This control pin allows the mixer output pins to be put into a high impedance state. This allows the transmit signal path to share the same IF filter as the receiver.	
10	VCC3	Supply voltage for mixer preamp.	See pin 12.
11	GND3	Ground pin for mixer preamp. This lead inductance should be kept small.	See pin 12.
12	MIX IN	Mixer RF Input port. This pin is NOT internally DC blocked. An external blocking capacitor must be provided if the pin is connected to a device with DC present. A value of $>22\text{pF}$ is recommended. To minimize the noise figure it is recommended to have a bandpass filter before this input. This will prevent the noise at the image frequency from being converted to the IF.	

Pin	Function	Description	Interface Schematic
13	NC		
14	NC		
15	LNA OUT	RF signal output for external 50Ω filtering. The use of a filter here is optional but does provide for lower noise floor and better out-of-band rejection.	See pin 16.
16	VCC4	Supply voltage for the LNA. This pin should be bypassed with a 10 pF capacitor to ground as close to the pin as possible. The shunt inductance from this pin to ground via the supply decoupling must be tuned to match the LNA output to 50Ω at the desired operating frequency.	

Theory of Operation

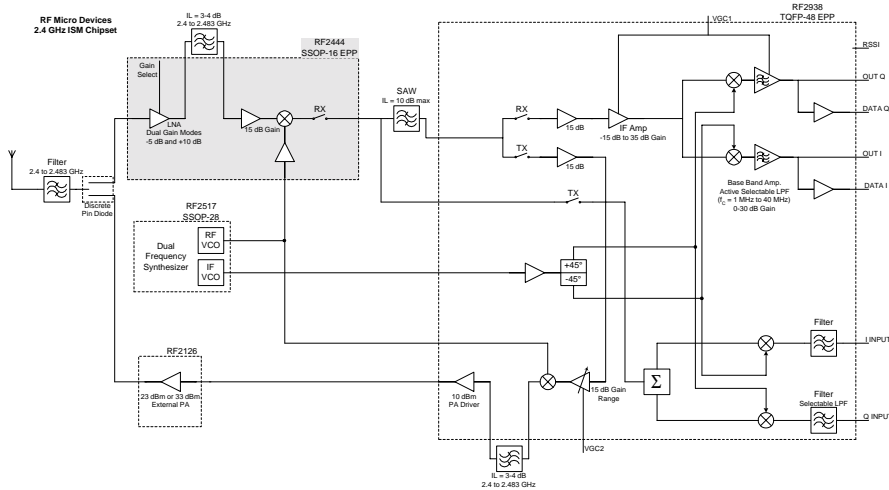

Figure 1. Entire Chipset Functional Block Diagram

The RF2444 contains the LNA/Mixer for this chipset. The LNA is made from two stages including a common emitter amplifier stage with a power gain of 13dB and an attenuator which has an insertion loss of 3dB in high gain mode, and 17dB in low gain mode. The attenuator was put after the LNA so that system noise figure degradation would be minimized. A single gain stage was used prior to the image filter to maximize IP3 which minimizes the risk of large out-of-band signals jamming the desired signal.

The mixer on the RF2444 is also two stages. The first stage is a common emitter amp used to boost the total power gain prior to the lossy SAW filter, to convert to a differential signal to the input of the mixer, and to improve the noise figure of the mixer. The second stage is a double balanced mixer whose output is differential open collector. It is recommended that a "current combiner" is used (as shown in figure 2) at the mixer output to maximize conversion gain, but other loads can also be used. The current combiner is used to do a differential to single ended conversion for the SAW filter. C1, C2 and L1 are used to tune the circuit for a specific IF frequency. L2 is a choke to supply DC current to the mixer that is also used as a tuning element, along with C3, to match to the SAW filter's input impedance. RL is the SAW filter's input impedance.

The mixer power conversion gain is +19dB when R1 is set to 1kΩ. The conversion gain can be adjusted up ~5dB or down ~7dB by changing the value of R1. Once R1 is chosen, L2 and C3 can be used to tune the output for the SAW filter.

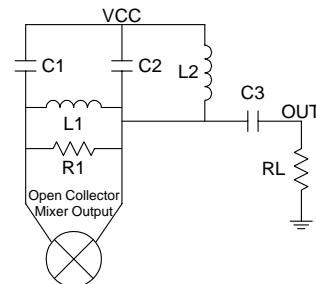
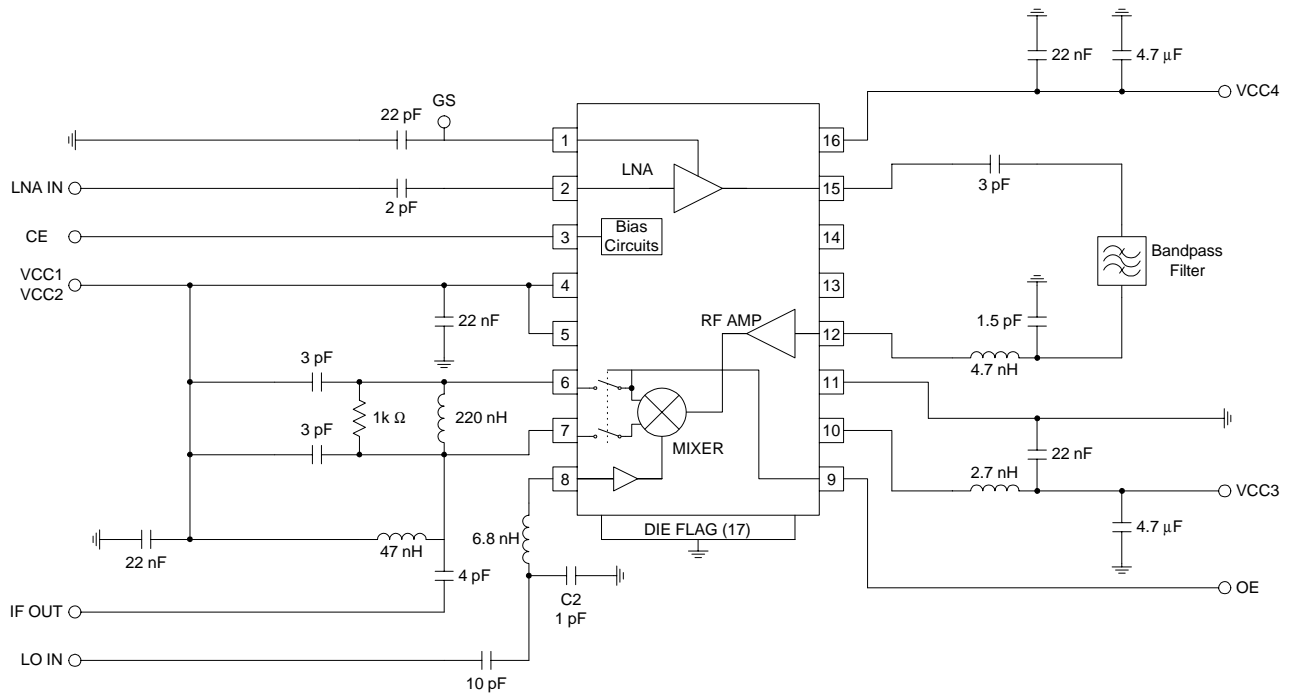

Figure 2. Current Combiner for Mixer Load

The cascaded power gain of the LNA/Mixer is 29dB, which after insertion loss in the image filter (~3dB) and IF SAW filter (~10dB), still gives 16dB of gain prior to the IF amps. Because of this, the noise figure of the IF amps should not significantly degrade system noise figure.

The LNA input should be matched for a good return loss for optimum gain and noise figure. To allow the designer to match each of these ports, 2-port s-parameter data is available for the LNA, and 1-port data is available for MIXER IN and LO IN.

Application Schematic



RF2444

Evaluation Board Schematic

(Download [Bill of Materials](http://www.rfmd.com) from www.rfmd.com.)

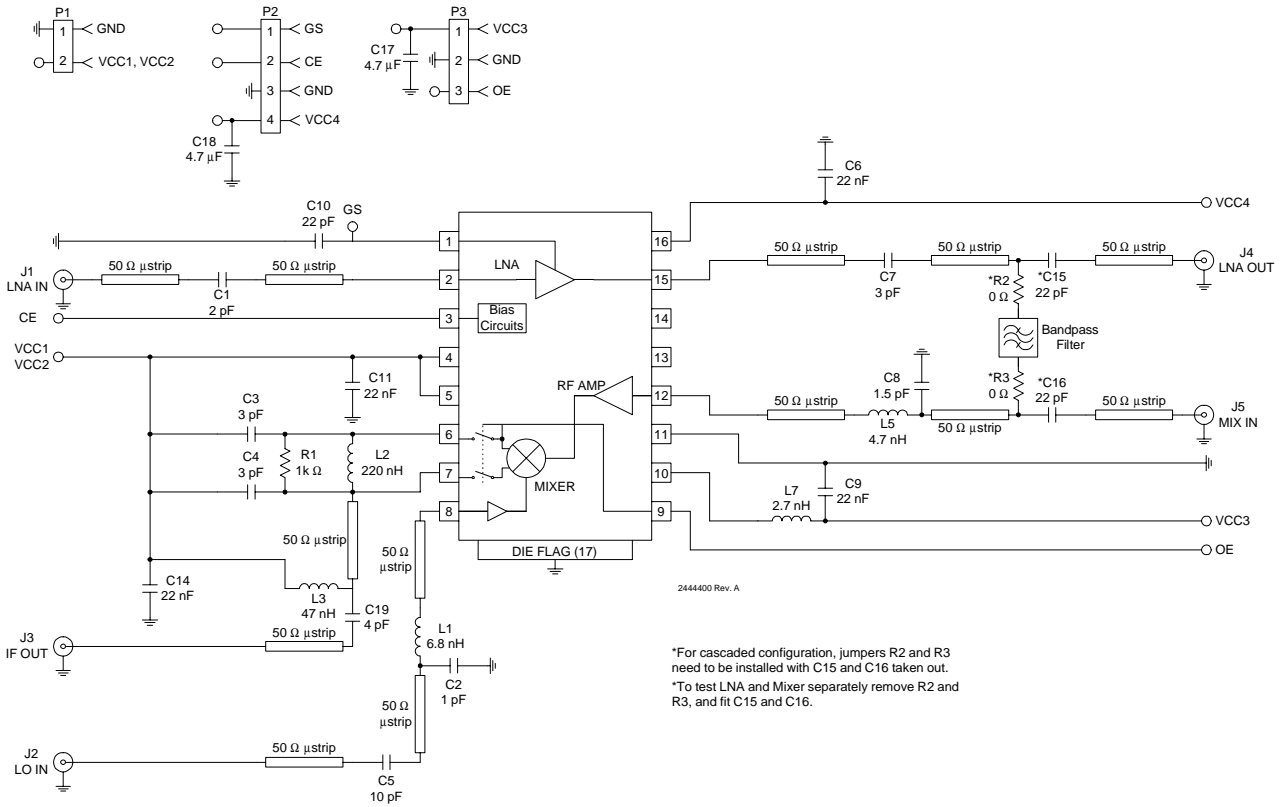

Evaluation Board Layout
 Board Thickness 0.031", Board Material FR-4

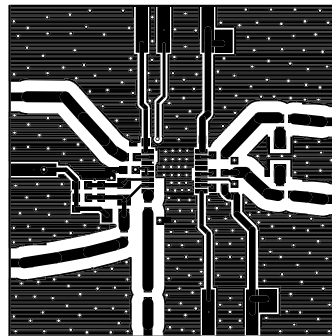
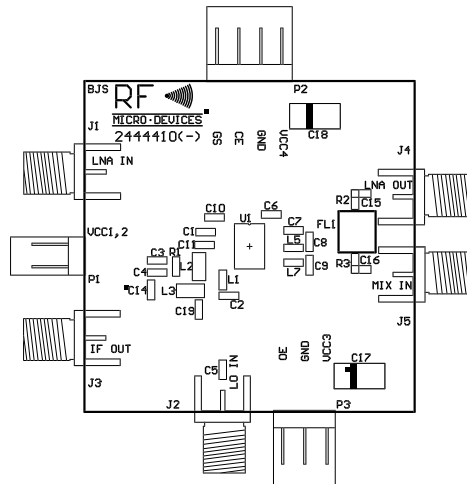

NOTE: In the following charts, all cascaded data measured with a bandpass filter inserted between LNA OUT and MIX IN, having cut frequencies: $f_L=2400\text{MHz}$, $f_M=2484\text{MHz}$, and insertion loss=1.2dB.

LNA + Mixer Gain versus VCC (2.45 GHz),
Attenuator Off

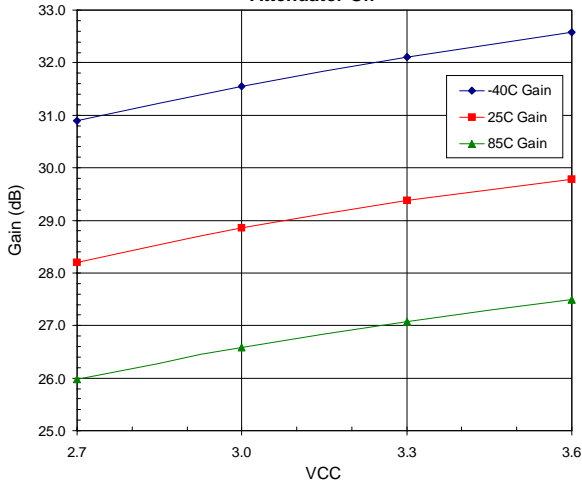

LNA + Mixer IIP3 versus VCC (2.45 GHz),
Attenuator Off

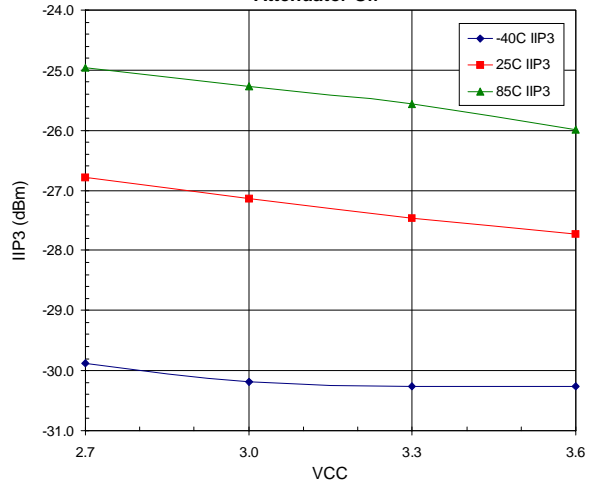

LNA + Mixer Gain versus RF Frequency (3.3 V),
Attenuator Off

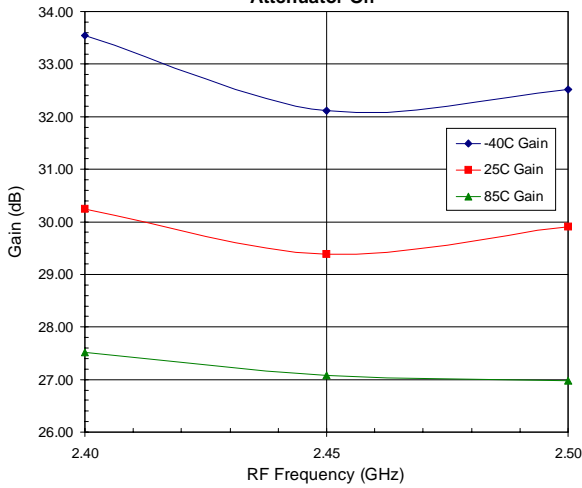

LNA + Mixer IIP3 versus RF Frequency (3.3V),
Attenuator Off

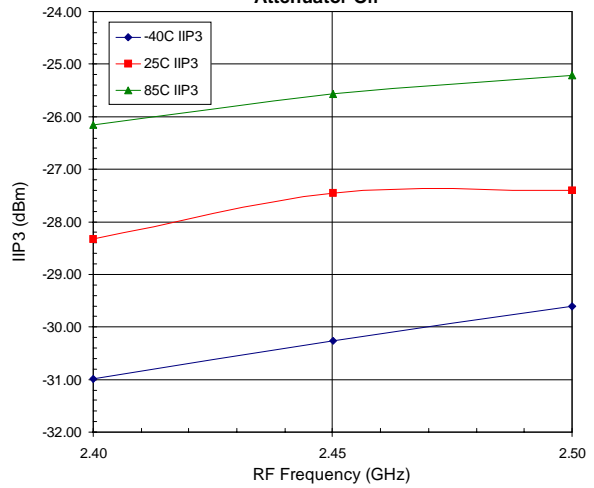

LNA + Mixer Gain versus VCC (2.45 GHz),
Attenuator On

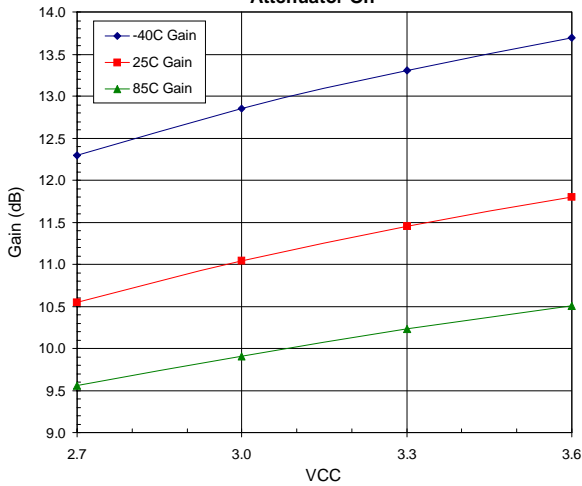

LNA + Mixer IIP3 versus VCC (2.45 GHz),
Attenuator On

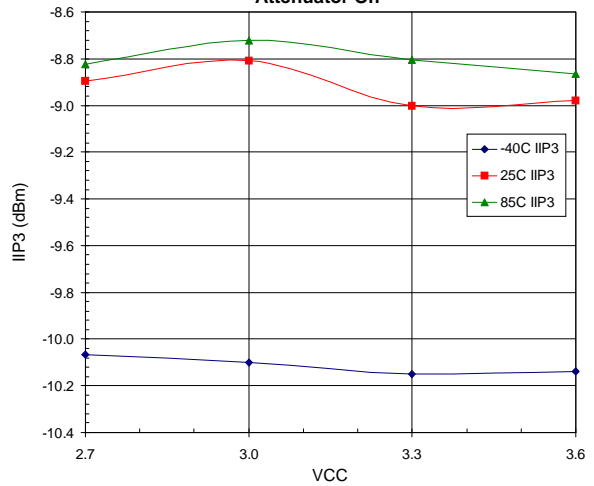

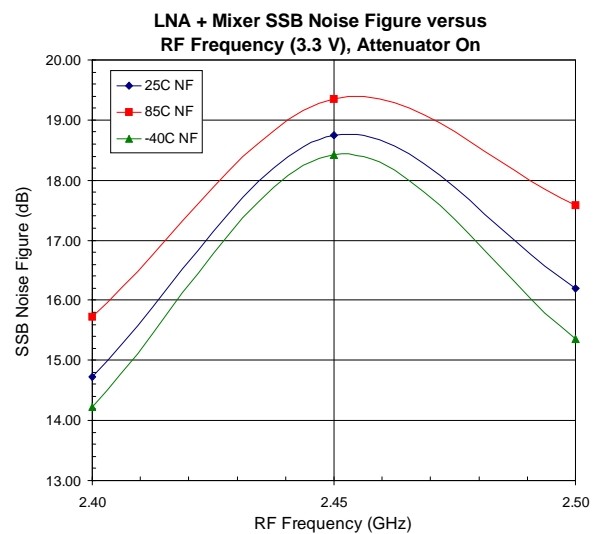
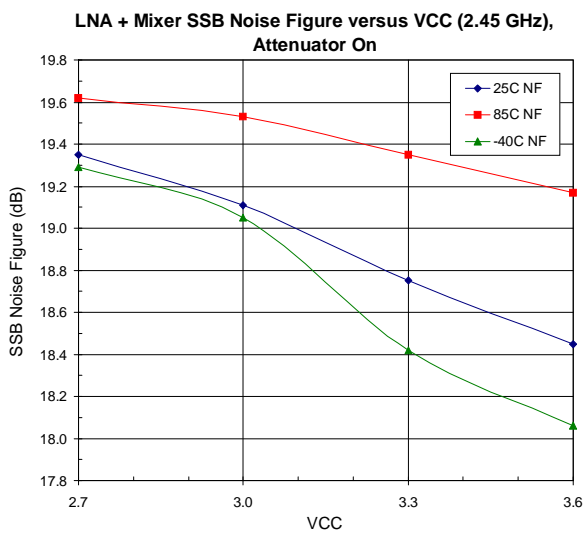
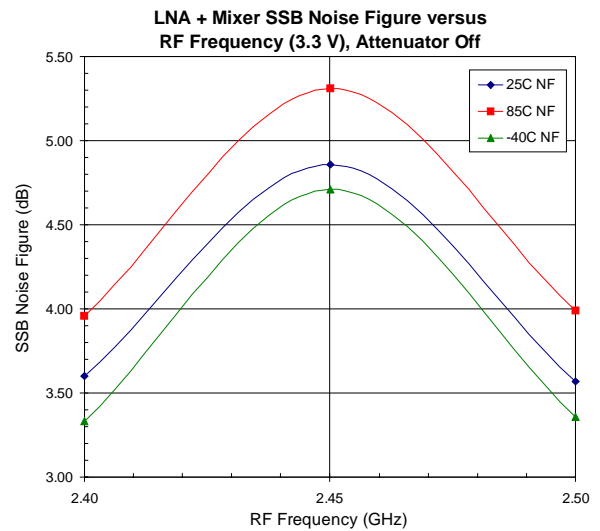
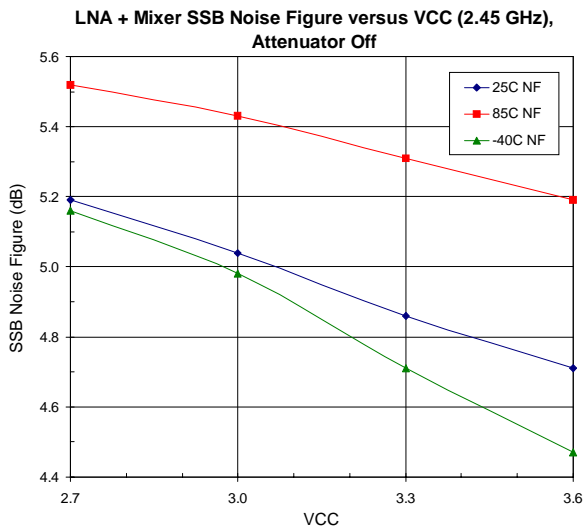
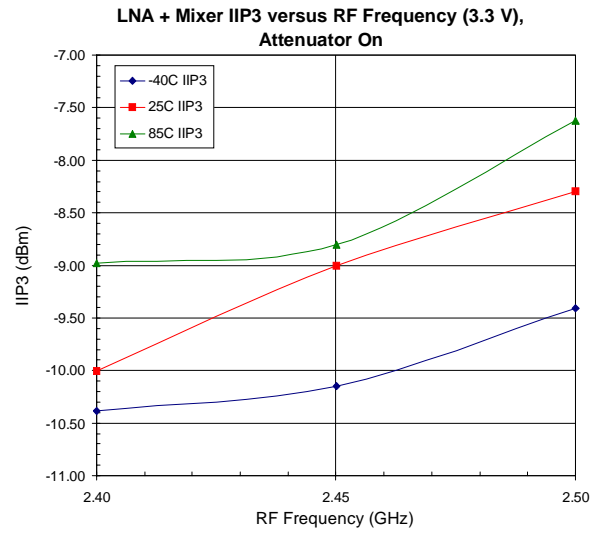
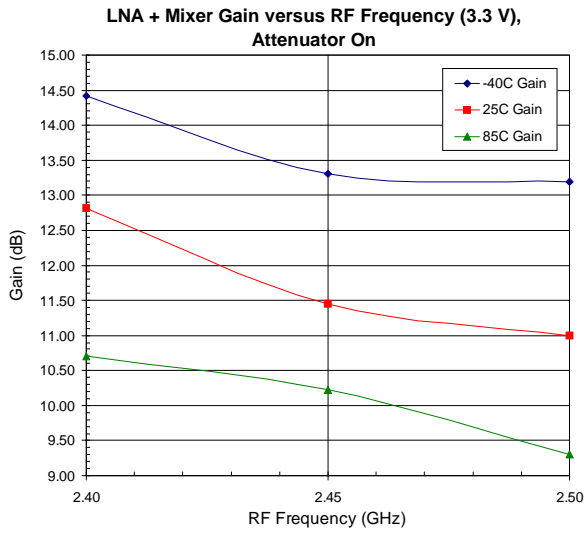

LNA + Mixer Gain versus IF Frequency (3.3 V)

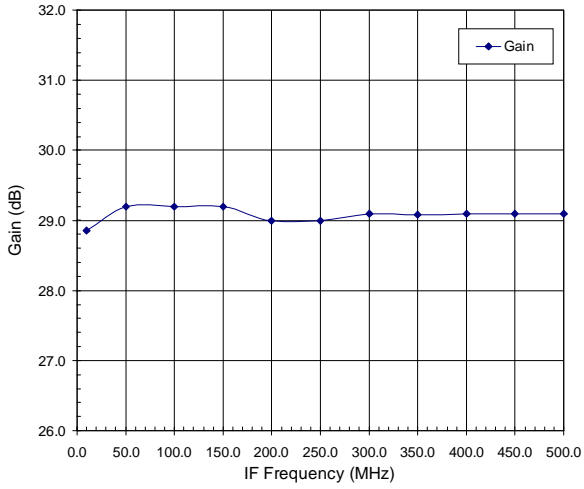

LNA + Mixer IIP3 versus IF Frequency (3.3 V)

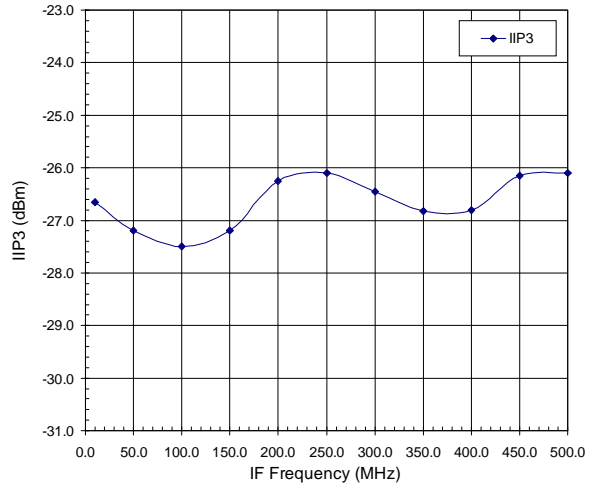

LNA I_{cc} versus VCC (PD = 1, RX EN = 0)

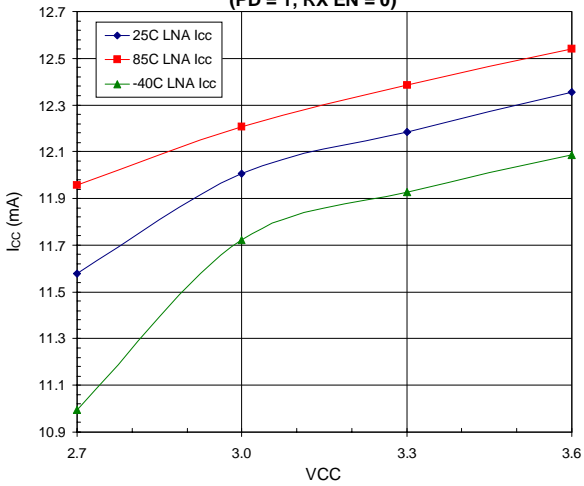

Total I_{cc} versus VCC (PD = 1, RX EN = 1)

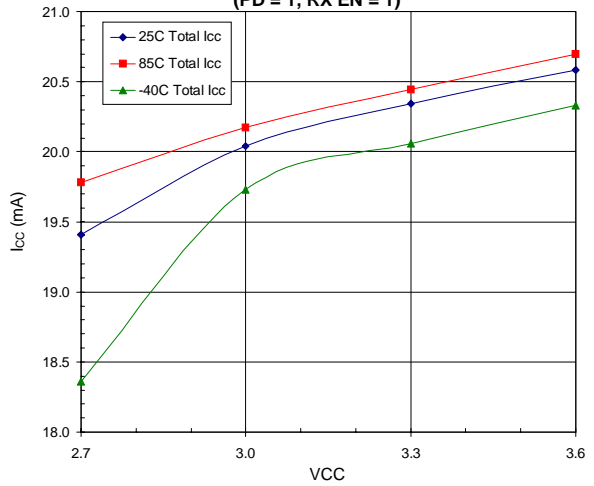

Isolation

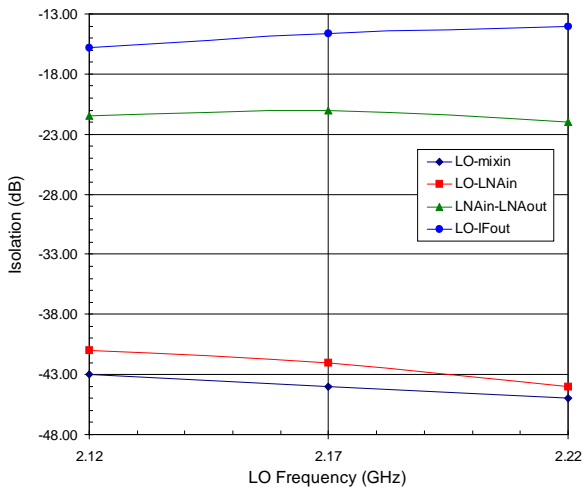

**LNA Gain versus VCC (2.45 GHz),
Attenuator Off**

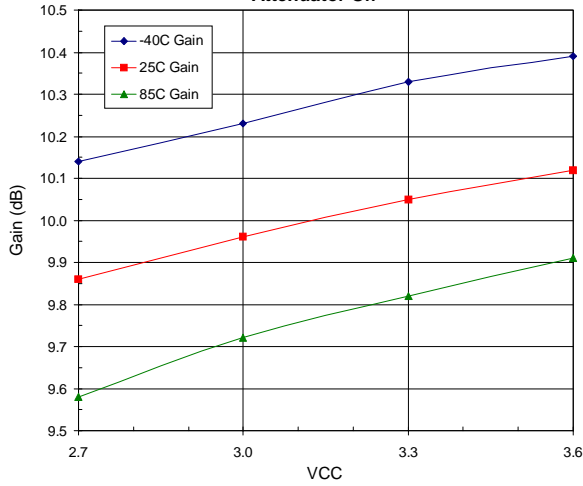

**LNA IIP3 versus VCC (2.45 GHz),
Attenuator Off**

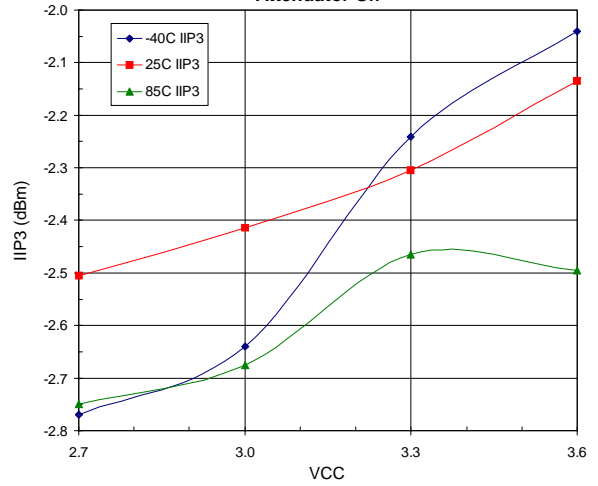

**LNA Gain versus VCC (2.45 GHz),
Attenuator On**

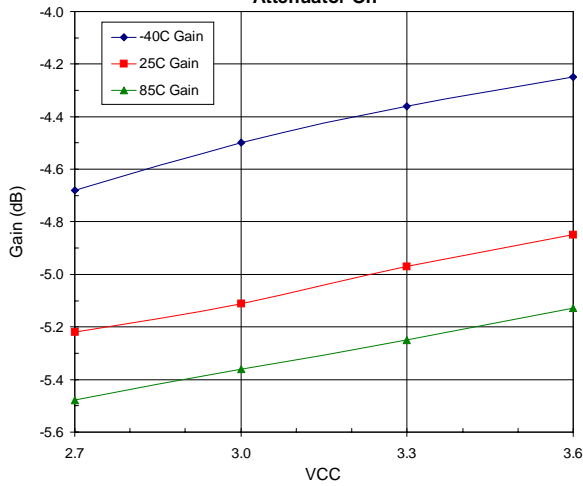

**LNA IIP3 versus VCC (2.45 GHz),
Attenuator On**

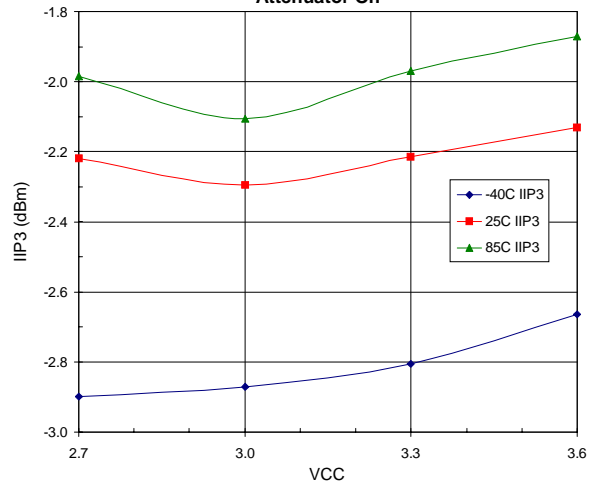

**LNA Gain versus RF Frequency (3.3 V),
Attenuator Off**

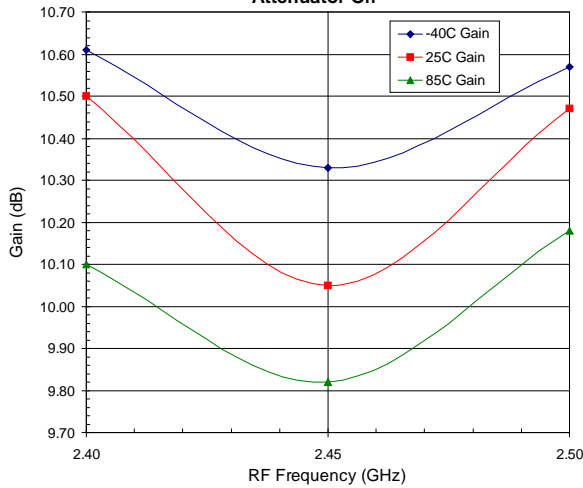

**LNA IIP3 versus RF Frequency (3.3 V),
Attenuator Off**

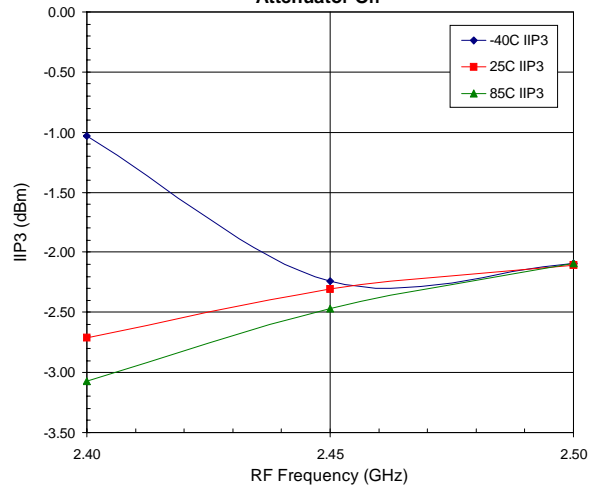

RF2444

LNA Gain versus RF Frequency (3.3 V),
Attenuator On

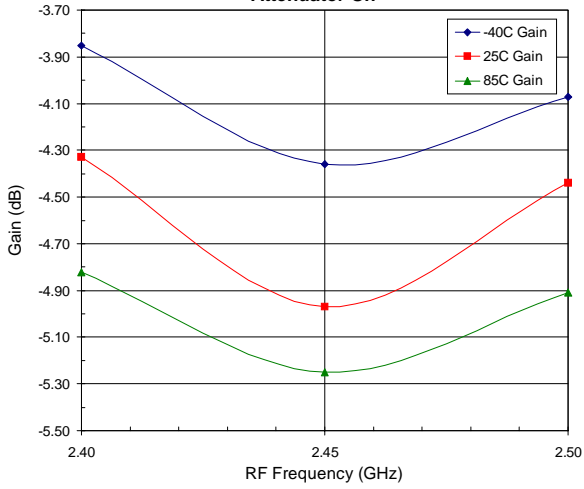

LNA IIP3 versus RF Frequency (3.3 V),
Attenuator On

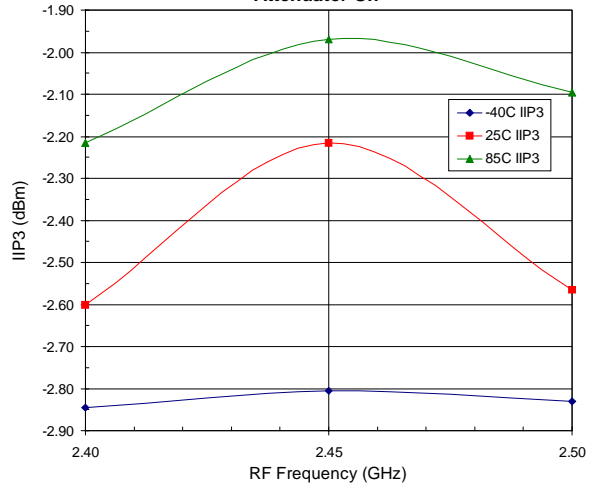

LNA Noise Figure versus VCC (2.45 GHz),
Attenuator Off

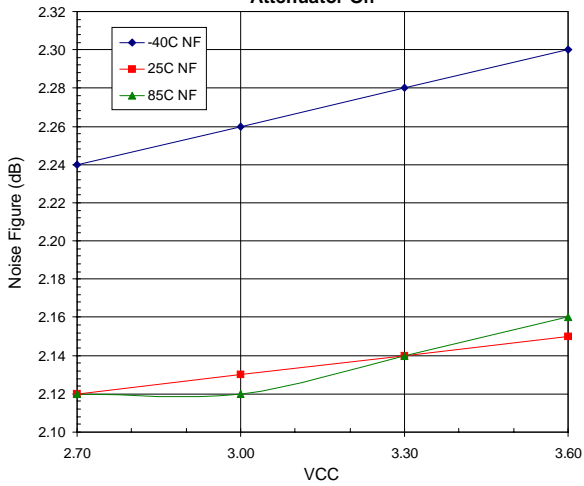

LNA Noise Figure versus RF Frequency (3.3 V),
Attenuator Off

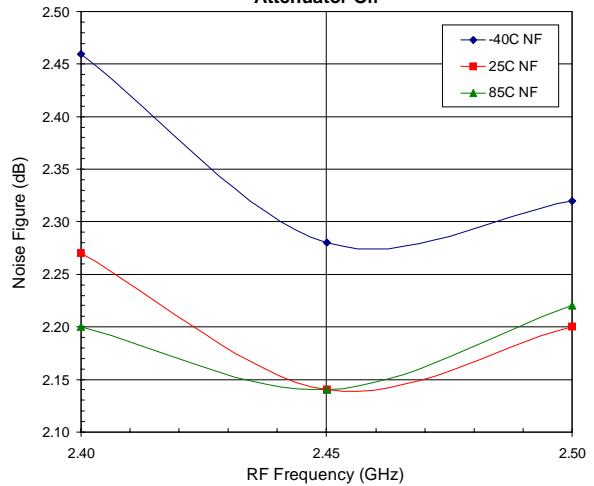

LNA Noise Figure versus VCC (2.45 GHz),
Attenuator On

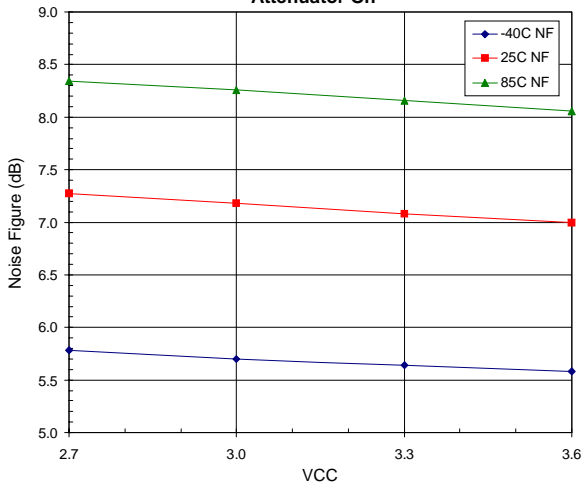

LNA Noise Figure versus RF Frequency (3.3 V),
Attenuator On

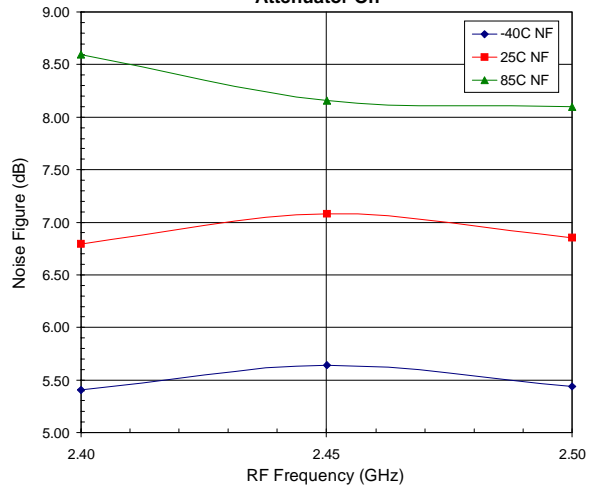

Mixer Gain versus VCC (2.45 GHz)

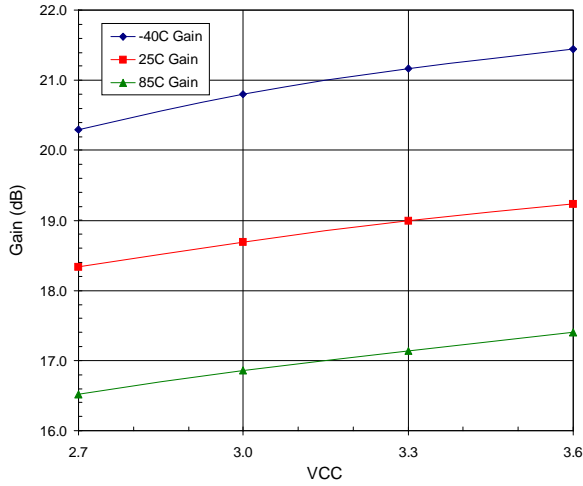

Mixer IIP3 versus VCC (2.45 GHz)

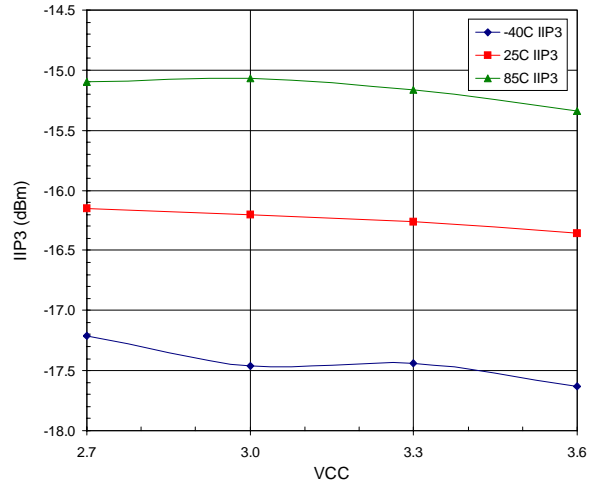

Mixer Gain versus RF Frequency (3.3 V)

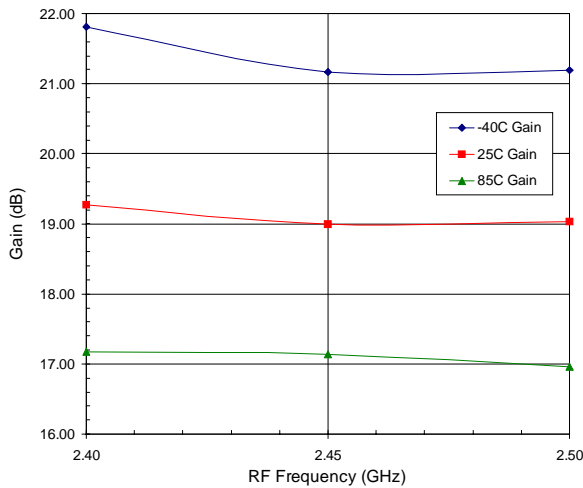

Mixer IIP3 versus RF Frequency (3.3 V)

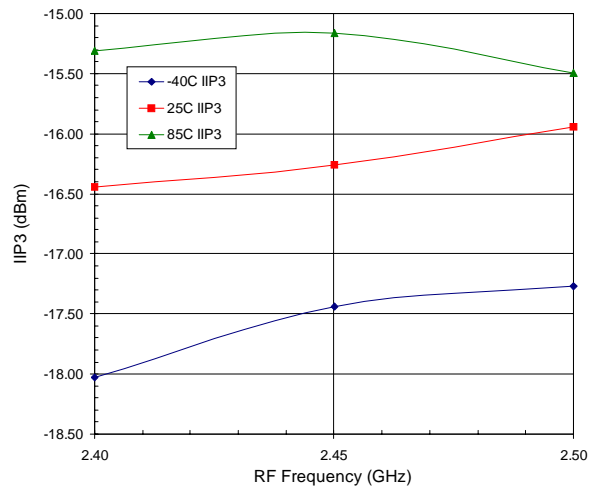

Mixer SSB Noise Figure versus VCC (2.45 GHz)

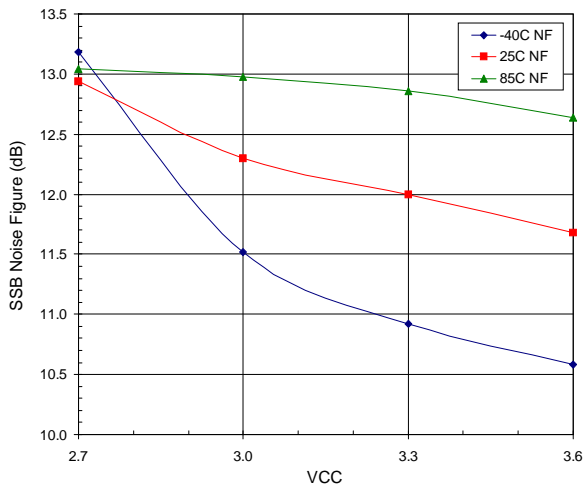

Mixer SSB Noise Figure versus RF Frequency (3.3 V)

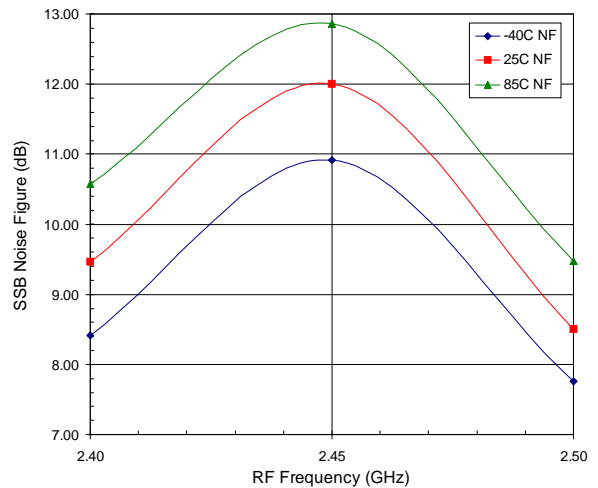

RF2444

