

Typical Applications

- TDMA/EDGE Handsets
- TDMA IS-136 Handsets
- GAIT Handsets
- TDMA/GSM Dual-Band Handsets
- GSM/DCS/EDGE Handsets

Product Description

The RF2488 is a dual-band LNA/Mixer designed to support dual-band, multi-mode handset applications. The unique dual IF outputs provide interface to two independent IF SAW filters supporting applications that combine IS136 with GSM, DCS or EDGE air interfaces. The device includes four mixers, providing the ability to use two independent IF bandwidths accessible from either the low or high band LNAs. Each LNA has a gain bypass mode controlled by the GAIN SEL pin. An image reject filter is required between each LNA and its mixer. Power management is implemented based on a three-pin logic level interface. Power consumption is minimized by shutting down all but the active sections of the device.

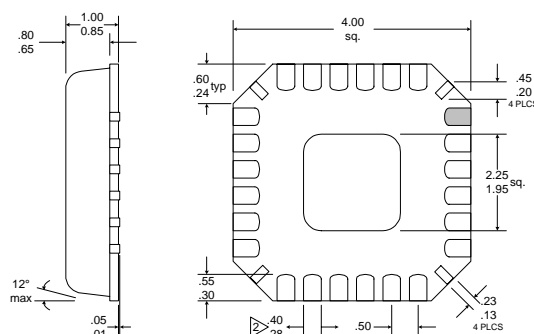

- NOTES:
- 1 Shaded Pin is Lead 1.
  - 2 Dimension applies to plated terminal: to be measured between 0.02 mm and 0.25 mm from terminal end.
  - 3 Pin 1 identifier must exist on top surface of package by identification mark or feature on the package body. Exact shape and size is optional.
  - 4 Package Warpage: 0.05 mm max.
  - 5 Die Thickness Allowable: 0.305 mm max.

Optimum Technology Matching® Applied

- |                                     |  |                                      |
|-------------------------------------|--|--------------------------------------|
| <input type="checkbox"/> Si BJT     | <input type="checkbox"/> GaAs HBT            | <input type="checkbox"/> GaAs MESFET |
| <input type="checkbox"/> Si Bi-CMOS | <input checked="" type="checkbox"/> SiGe HBT | <input type="checkbox"/> Si CMOS     |

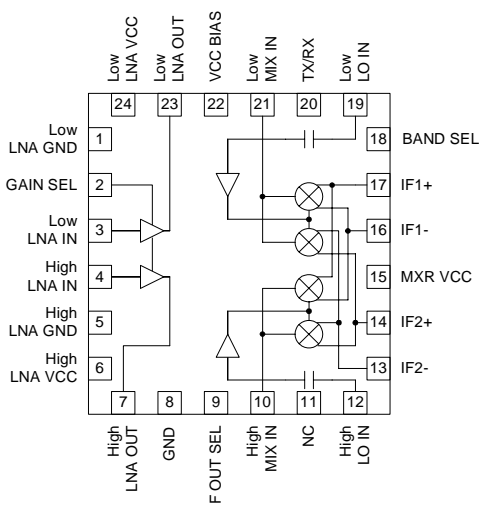

Functional Block Diagram

Package Style: LCC, 24-Pin, 4 x 4

Features

- Complete Dual-Band Front-End
- Switchable LNA Gain
- Low Noise and High Intercept Point
- Low Current Consumption
- Single 2.7V to 3.3V Power Supply
- Supports Dual IF Bandwidths

Ordering Information

- |             |                                  |
|-------------|----------------------------------|
| RF2488      | Multi-Mode Dual-Band LNA Mixer   |
| RF2488 PCBA | Fully Assembled Evaluation Board |

RF Micro Devices, Inc.  
7625 Thorndike Road  
Greensboro, NC 27409, USA

Tel (336) 664 1233  
Fax (336) 664 0454  
<http://www.rfmd.com>

### Absolute Maximum Ratings

Parameter	Rating	Unit
Supply Voltage	-0.5 to +3.6	V
Input LO and RF Levels	10	dBm
Operating Ambient Temperature	-40 to +85	°C
Storage Temperature	-40 to +125	°C



**Caution!** ESD sensitive device.

RF Micro Devices believes the furnished information is correct and accurate at the time of this printing. However, RF Micro Devices reserves the right to make changes to its products without notice. RF Micro Devices does not assume responsibility for the use of the described product(s).

Parameter	Specification			Unit	Condition
	Min.	Typ.	Max.		
<b>Operating Range</b>					
Supply Voltage	2.7	3	3.3	V	@ 3V in any mode. T=25°C
Supply Current		22	24	mA	
RF Frequency Range	800		1000	MHz	
	1800		2000	MHz	
LO Frequency Range	885		1400	MHz	
	1885		2400	MHz	
IF Frequency Range	85		400	MHz	
Temperature Range	-40		+85	°C	
<b>Low Noise Amplifier</b>					T <sub>AMB</sub> =25°C, V <sub>CC</sub> =3V
<b>Low Band</b>					Frequency=869MHz to 894MHz
Gain	17	18	19	dB	High Gain, GAIN SEL=High
	-11	-9	-8	dB	Low Gain, GAIN SEL=Low
Gain Variations versus Temperature			±0.75	dB	-40°C to +85°C
Noise Figure		1.25	1.35	dB	High Gain, GAIN SEL=High
		10	12	dB	Low Gain, GAIN SEL=Low
Input 3rd Order Intercept	0	3		dBm	High Gain, GAIN SEL=High
	22	25		dBm	Low Gain, GAIN SEL=Low
Return Loss	10			dB	LNA Input-External Match, GAIN SEL=High
	10			dB	LNA Input-External Match, GAIN SEL=Low
	10			dB	LNA Output-External Match, GAIN SEL=High
	10			dB	LNA Output-External Match, GAIN SEL=Low
Supply Current		4	5	mA	High Gain, GAIN SEL=High
		0.3	0.5	mA	Low Gain, GAIN SEL=Low
<b>Mixer Low Band</b>					T <sub>AMB</sub> =25°C, V <sub>CC</sub> =3V, IF=135MHz;
					Mixer RF Input Frequency=869MHz to 894MHz; LO Input Frequency=1004MHz to 1029MHz
Conversion Gain	9	10	11	dB	
LO Input Level	-9	-6	0	dBm	
Noise Figure (SSB)	10	10	12	dB	
Input 3rd Order Intercept	6	7		dBm	
Return Loss	10			dB	Mixer RF Input
	10			dB	LO Input
Terminating Impedance, IF Output		500		Ω	Mixer "ON"
Mixer Supply Current		12	13	mA	

Parameter	Specification			Unit	Condition
	Min.	Typ.	Max.		
<b>Low Band Cascaded Electrical Specification</b>					
Gain	24	26	28	dB	$T_{AMB}=25^{\circ}C$ , $V_{CC}=3V$ , $IF=135MHz$ . Assumes 3dB loss for image filter. High Gain, GAIN SEL=High Low Gain, GAIN SEL=Low
	-4	-2	0	dB	
Gain Variations versus Temperature			$\pm 1.0$	dB	
Noise Figure		2.1	2.5	dB	High Gain, GAIN SEL=High
		22	24	dB	Low Gain, GAIN SEL=Low
Input 3rd Order Intercept	-10	-8		dBm	High Gain, GAIN SEL=High
	16	18		dBm	Low Gain, GAIN SEL=Low
Return Loss	10			dB	LNA Input-External Match, GAIN SEL=High
	10			dB	LNA Input-External Match, GAIN SEL=Low
	10			dB	Mixer RF Input
	10			dB	Mixer LO Input
Isolation	50			dB	LO IN to LNA IN, GAIN SEL=High
	35			dB	LO IN to LNA IN, GAIN SEL=Low
	40	45		dB	LNA Out to Mixer RF In
		>50		dB	LO In to IF Out
		>40		dB	Mixer RF In to IF Out
IF Output Impedance		500		$\Omega$	Mixer "ON"
Supply Current		16	18	mA	High Gain, GAIN SEL=High
		13	15	mA	Low Gain, GAIN SEL=Low
<b>Low Noise Amplifier High Band</b>					
Gain	16	17	18	dB	$T_{AMB}=25^{\circ}C$ , $V_{CC}=3V$ Frequency=1930MHz to 1990MHz High Gain, GAIN SEL=High Low Gain, GAIN SEL=Low
	-8	-6	-4	dB	
Gain Variations versus Temperature			$\pm 1.0$	dB	-40°C to 85°C
Noise Figure		1.6	1.7	dB	High Gain, GAIN SEL=High
		8	11	dB	Low Gain, GAIN SEL=Low
Input 3rd Order Intercept	0	2		dBm	High Gain, GAIN SEL=High
	16	18		dBm	Low Gain, GAIN SEL=Low
Return Loss	10			dB	LNA Input-External Match, GAIN SEL=High
	10			dB	LNA Input-External Match, GAIN SEL=Low
	10			dB	LNA Output-External Match, GAIN SEL=High
	10			dB	LNA Output-External Match, GAIN SEL=Low
Supply Current		6	7	mA	High Gain, GAIN SEL=High
		0.3	0.5	mA	Low Gain, GAIN SEL=Low
<b>Mixer High Band</b>					
Conversion Gain	10	11	12	dB	$T_{AMB}=25^{\circ}C$ , $V_{CC}=3V$ , $IF=135MHz$ ; Mixer RF Input Frequency=1930MHz to 1990MHz; LO Output Frequency=2065MHz to 2125MHz
LO Input Level	-9	-6	0	dBm	
Noise Figure (SSB)		10	12	dB	
Input 3rd Order Intercept	5	7		dBm	
Return Loss, Mixer RF Input	10			dB	
LO Input	10			dB	
Terminating Impedance IF Output		500		$\Omega$	Mixer "ON"
Mixer Supply Current		16	17	mA	

Parameter	Specification			Unit	Condition
	Min.	Typ.	Max.		
<b>High Band Cascaded Electrical Specification</b>					
Gain	22	24	26	dB	$T_{AMB}=25^{\circ}C$ , $V_{CC}=3V$ , $IF=135MHz$ . Assumes 3dB loss for image filter. High Gain, GAIN SEL=High Low Gain, GAIN SEL=Low
	-2	0	2	dB	
Gain Variations versus Temperature			$\pm 1.5$	dB	
Noise Figure		2.6	3.0	dB	High Gain, GAIN SEL=High
		20	25	dB	Low Gain, GAIN SEL=Low
Input 3rd Order Intercept	-10	-8		dBm	High Gain, GAIN SEL=High
	16	18		dBm	Low Gain, GAIN SEL=Low
Return Loss	10			dB	LNA Input-External Match, GAIN SEL=High
	10			dB	LNA Input-External Match, GAIN SEL=Low
	10			dB	Mixer RF Input
	10			dB	Mixer LO Input
Isolation	50			dB	LO IN to LNA IN, GAIN SEL=High
	50			dB	LO IN to LNA IN, GAIN SEL=Low
	40	45		dB	LNA Out to Mixer RF In
		>50		dB	LO In to IF Out
		>60		dB	Mixer RF In to IF Out
Half IF Spur		-68	-60	dBc	
IF Output Impedance		500		$\Omega$	Mixer "ON"
Supply Current		22	24	mA	High Gain, GAIN SEL=High
		18	22	mA	Low Gain, GAIN SEL=Low
<b>Logic Levels</b>					
Input Low			0.5	V	$V_{CC}=2.7V$ to 2.9V
Input High	2.0			V	$V_{CC}=2.7V$ to 2.9V
Input Current		10	100	$\mu A$	
Input Impedance	2	20		k $\Omega$	

Pin	Function	Description	Interface Schematic
1	Low LNA GND	Low band LNA ground connection. As an option, an external inductor to ground may be used to reduce LNA gain.	See pin 3.
2	GAIN SEL	CMOS compatible signal controlling both the low band and high band LNA gain. Logic (0)=Low Gain, Logic (1)=High Gain.	
3	Low LNA IN	Low band LNA input. The maximum VSWR is 2:1 (Cell/GSM RX band) for both the gain and bypass mode. This pin is internally DC-biased and should be DC blocked with a capacitor suitable for the frequency of operation.	
4	High LNA IN	High band LNA input. The maximum VSWR is 2:1 (DCS/PCS RX band) for both the gain and bypass mode. This pin is internally DC-biased and should be DC blocked with a capacitor suitable for the frequency of operation.	
5	High LNA GND	High band LNA ground connection. Immediate grounding required adjacent to pin.	See pin 4.
6	High LNA VCC	High band LNA supply voltage. Local bypass capacitor required.	
7	High LNA OUT	High band LNA Output. Bias for the LNA is provided through this pin, hence it should be connected to V <sub>CC</sub> through an inductor.	See pin 4.
8	GND	Direct connection to ground.	
9	IF OUT SEL	IF output select state control pin. This CMOS compatible signal controls the selection of the IF mixer output path (see the State Control Truth Table). Local bypass capacitor required.	
10	High MIX IN	High band RF mixer input. Although the base of the mixer input transistor is AC coupled, this pin serves a dual purpose of providing a DC-bias path via external inductor to GND. The typical input impedance is 8Ω real and requires external matching to 50Ω.	
11	NC		
12	High LO IN	High band local oscillator input. This pin is internally AC-coupled and matched to 50Ω.	See pin 19.
13	IF2-	IF output. Open collector output, requires external matching components and DC connection to V <sub>CC</sub> .	
14	IF2+	IF output. Open collector output, requires external matching components and DC connection to V <sub>CC</sub> .	See pin 13.
15	MXR VCC	Mixer supply voltage. Local bypass capacitor required.	

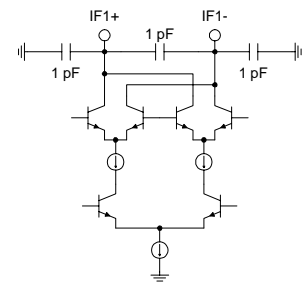
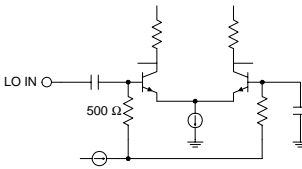
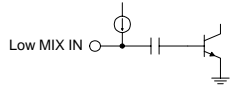
Pin	Function	Description	Interface Schematic
16	IF1-	IF output. Open collector output, requires external matching components and DC connection to $V_{CC}$ .	
17	IF1+	IF output. Open collector output, requires external matching components and DC connection to $V_{CC}$ .	See pin 16.
18	BAND SEL	This CMOS compatible pin controls the selection of the low or high band signal path (See the State Control Truth Table). Local bypass capacitor required.	
19	Low LO IN	LO band local oscillator input. This pin is AC-coupled and matched to $50\Omega$ .	
20	TX/RX	This CMOS compatible TX/RX mode select Power Control Pin. CMOS compatible signal controlling the functional state of the device (See the State Control Truth Table). Local bypass capacitor required.	
21	Low MIX IN	Low band RF mixer input. Although the base of the mixer input transistor is AC coupled, this pin serves a dual purpose of providing a DC bias path via external inductor to GND. The typical input impedance is $8\Omega$ real and requires external matching to $50\Omega$ .	
22	VCC BIAS	Bias supply voltage. Local bypass capacitor required.	
23	Low LNA OUT	Low band LNA output. Bias for the LNA is provided through this pin, hence it should be connected to VCC through an inductor.	See pin 3.
24	Low LNA VCC	Low band LNA RF supply voltage. Local bypass capacitor required.	

RF2488 State Control Truth Table

State	TX/RX	Band Sel	IF Out Sel	Active Circuits
0	0	0	0	Low Band LNA, IF1 Mixer
1	0	0	1	Low Band LNA, IF2 Mixer
2	0	1	0	High Band LNA, IF1 Mixer
3	0	1	1	High Band LNA, IF2 Mixer
4	1	0	0	All Off
5	1	0	1	All Off
6	1	1	0	All Off
7	1	1	1	All Off

## Detailed Description

The RF2488 is fabricated on a high performance Silicon Germanium process that allows optimization of key RF parameters (including noise figure, gain and linearity) for very low current consumption. The RF2488 is packaged in a small 24-pin, 4mmx4mm, leadless chip carrier. It can be operated on a single supply voltage from 2.7V to 3.3V. To reduce power consumption the RF2488 has a standby mode that draws less than 10uA.

The RF2488 has two frequency bands of operation. Each is comprised of an LNA and two downconverting mixers with combined RF inputs, and two separate intermediate frequency outputs. The LNA outputs and mixer RF inputs are typically connected through an image reject SAW filter, which provides image rejection and out-of-band blocking with low in-band insertion loss. Either of the two IF outputs can be selected whether operating in low band or high band mode. This feature allows different IF frequencies and SAW filters to be used for different air interfaces in multi-mode phones. The modes are selected using the external BAND SEL and IF SEL pins; these can be switched using standard CMOS logic levels.

### LNA

There are two LNA circuits: one for high band and one for low band. They have two gain conditions: high gain and low gain. The gain state is selected using the external GAIN SEL pin that can be switched with standard CMOS logic levels.

The LNAs require a DC-blocking capacitor at the input and an inductor to ground; the inductor is used to provide additional input linearity and can be removed if the linearity is not required. The LNA output requires an output match, which is determined by the input impedance of the IR SAW filter (typically 50Ω). The match must include an inductor to supply to provide the LNA with a DC path to  $V_{CC}$ .

In high gain mode, the low band LNA exhibits 18dB of gain combined with a noise figure of <1.4dB and a input IP3 (IIP3) of 3dB. In low gain mode, the device switches to a highly linear state, with IIP3 in excess of 20dBm and a gain of -9dB with a current drain of less than 500uA.

In high gain mode, the high band LNA exhibits 17dB of gain combined with a noise figure of <1.7dB and a IIP3 of 2dB. In low gain mode, the device switches to a highly linear state, with IIP3 in excess of 15dBm and a gain of -6dB with a current drain of less than 500uA.

### Mixers

The mixers are all single-balanced mixers, with low noise figure, high linearity and high gain. The RF input match can be tuned for a wide range of RF input frequencies. In low band mode, the match consists of an inductive choke to ground and a 7Ω to 50Ω step up input match. In high band mode, the match consists of a resonant circuit that provides a DC choke to ground and a 7Ω to 50Ω step up input match.

The LO input port is internally matched to 50Ω and is internally DC-blocked for easy interface across a wide bandwidth. The LO input can be driven with signals as low as -9dBm with no performance degradation. The matching of the IF outputs is discussed in the applications section.

Application Schematic

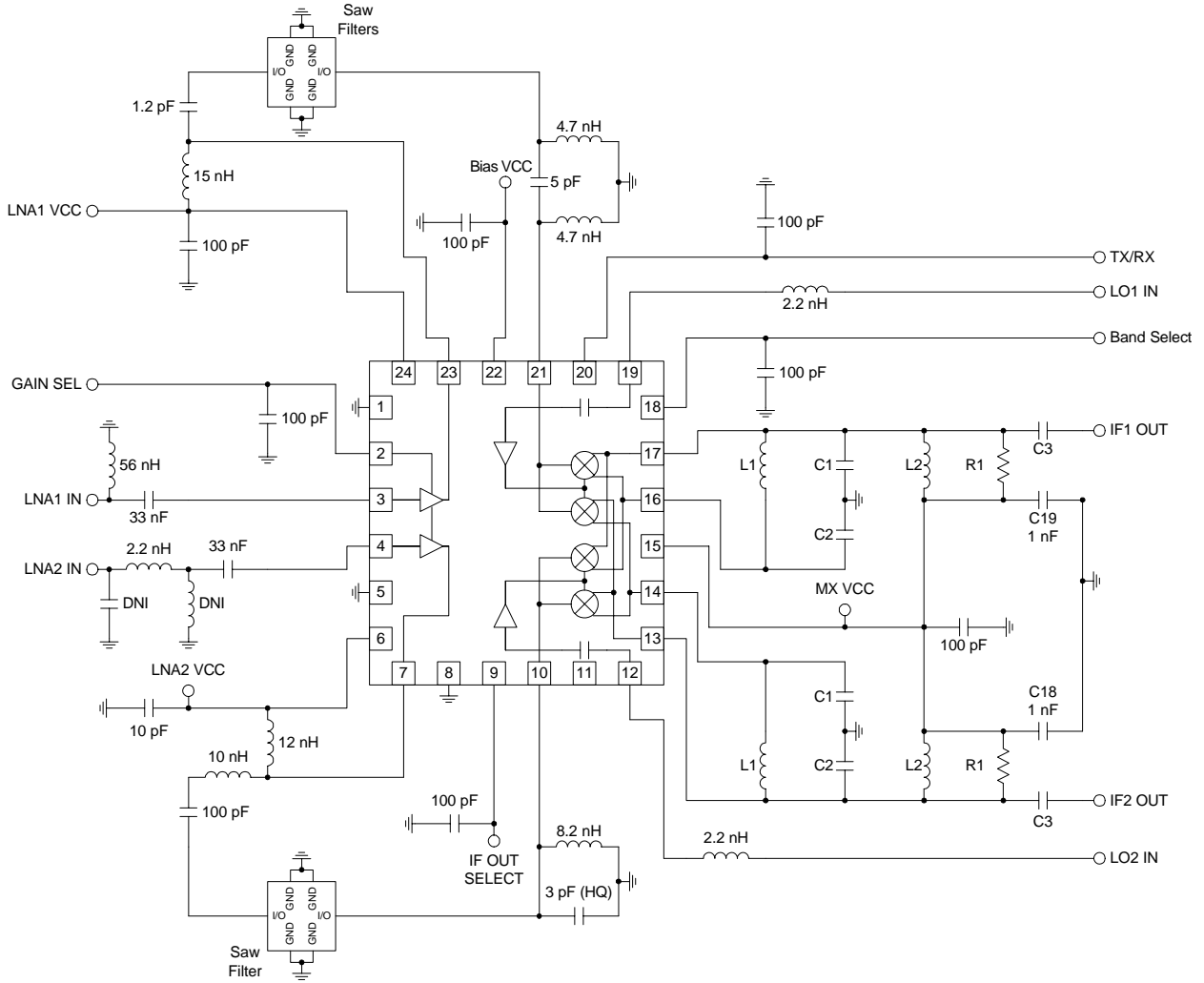

FRONT-ENDS



## Application Information

### Calculating the mixer output match

The evaluation boards mixer output match is explained below.

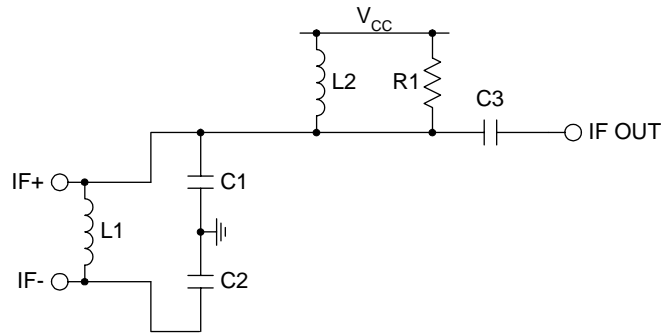

The match is made up of six components, each of which is discussed below.

#### Inductor L1

This inductor, along with capacitors C1 and C2 determine the resonant frequency of the current combining circuit, as well as the output impedance at the resonant point. The output impedance will be dependent on the parasitic resistance of the inductor  $R_P$ . A high Q inductor will result in a high output impedance.

#### Inductor L2

This inductor functions as a choke at the IF frequency, and should be made as large as possible, to not interact with the current combiner network. In addition, it provides a DC path from  $V_{CC}$  to the mixer core transistors.

#### Capacitors C1 and C2

These capacitors should be equal, and along with L1, define the resonant frequency.

#### Capacitor C3

This capacitor is used to provide a DC-block.

#### Resistor R1

This is primarily used to set the output impedance of the network. The impedance at the resonant frequency can be measured, and R1 can be placed in parallel to reduce the real impedance to the desired value. Alternatively, an approximation can be made using the following equation.

$$R_1 = \left( \frac{1}{R_{OUT}} - \frac{1}{R_P} \right)^{-1}$$

This is only an approximation, because it assumes the capacitors have infinite Q, and does not take into account PCB parasitics.

The following equation can be used to approximately calculate the resonant frequency of the circuit.

$$f_{IF} = \frac{1}{2\pi \sqrt{\frac{L1}{2}(C1 + C_{EQ})}}$$

Where  $C_{EQ}$  is the capacitance seen looking into IF+ and IF-, this is made up of an on-chip network that is used for high frequency filtering and any on-chip and PCB stray capacitances.

The internal network is shown below.

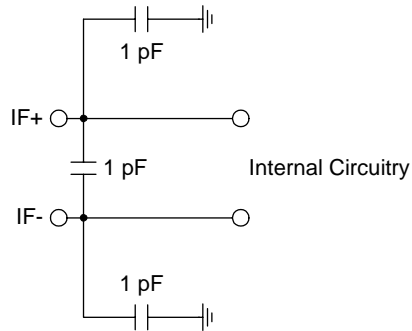



Evaluation Board Layout  
Board Size 2.3" x 1.9"

Board Thickness 0.062", Board Material FR-4, Multi-Layer  
Assembly Top

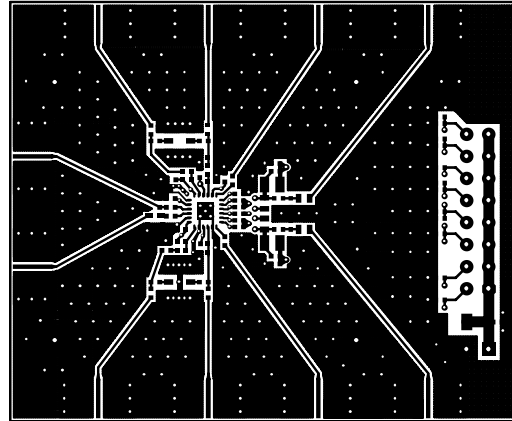
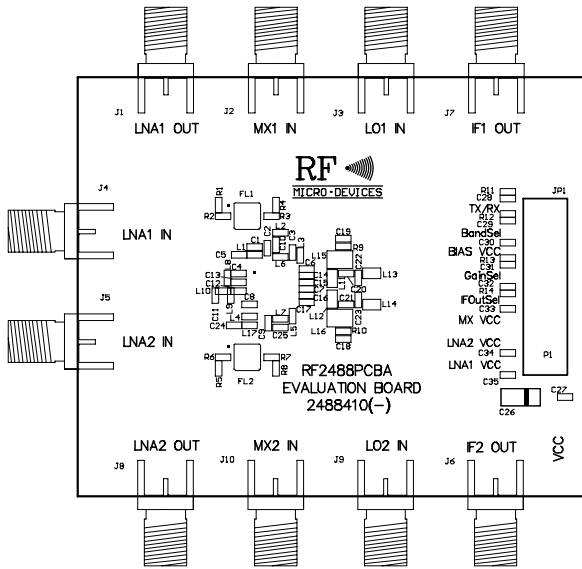

Inner 1

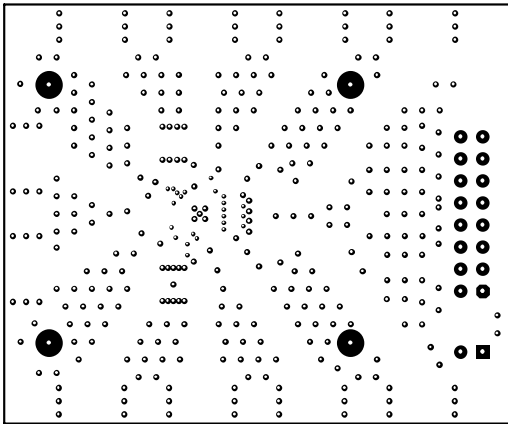

Inner 2

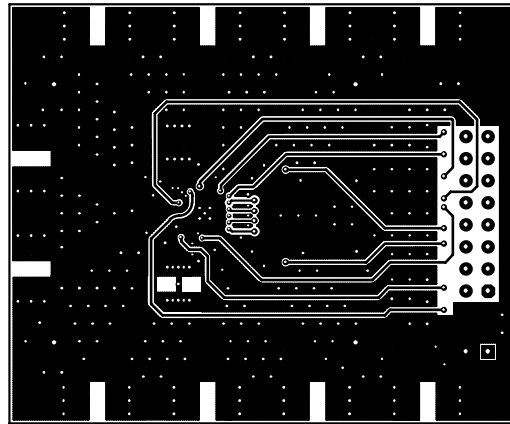

Back

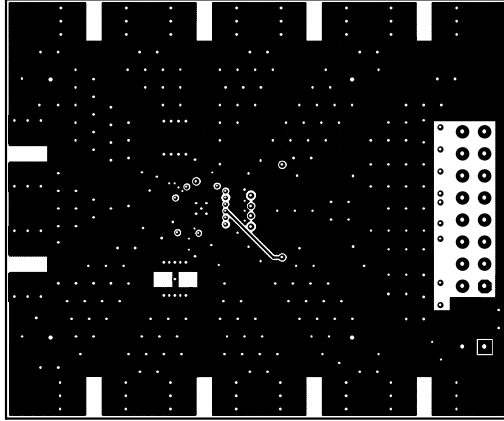

### LNA1 Gain versus Frequency

Gain Select=High,  $V_{CC}=3$  V

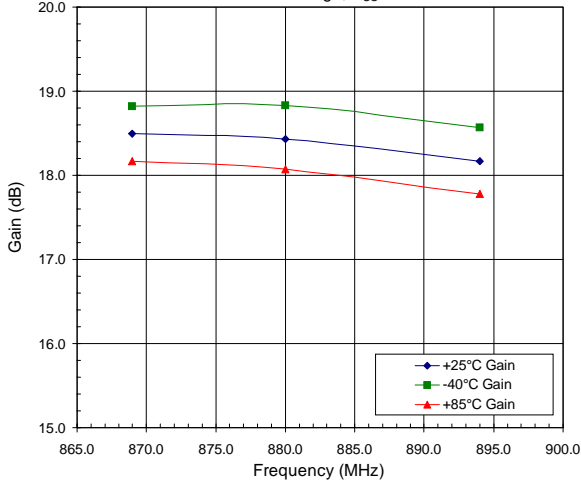

### LNA1 Gain versus Supply Voltage

Gain Select=High, 880 MHz

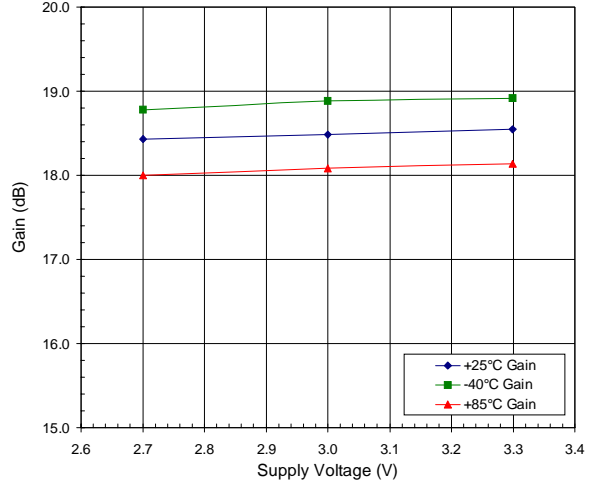

### LNA1 Noise Figure versus Frequency

Gain Select=High,  $V_{CC}=3$  V

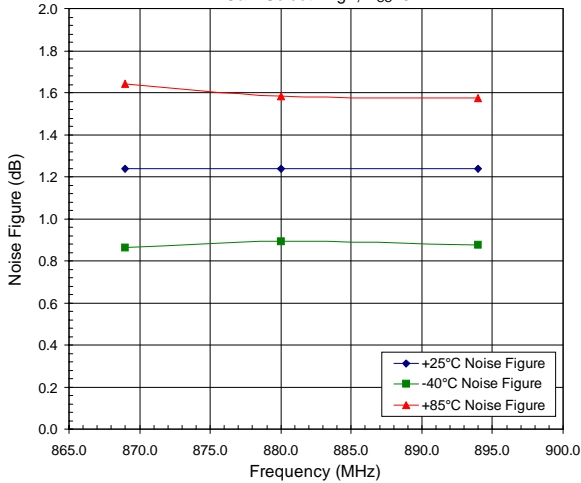

### LNA1 Noise Figure versus Supply Voltage

Gain Select=High, 880 MHz

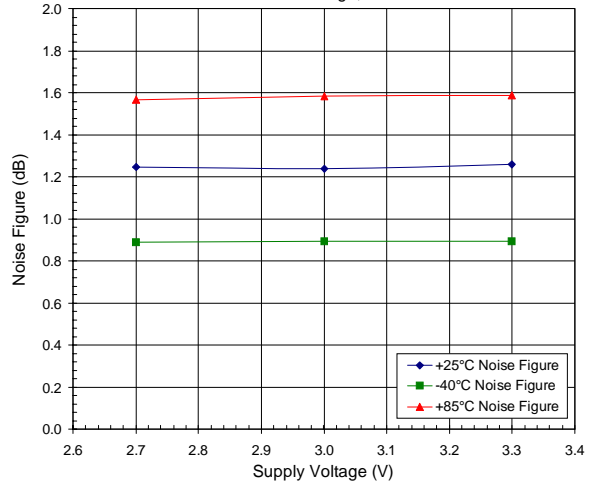

### LNA1 Input IP3 versus Frequency

Gain Select=High, -25 dBm per tone, 1 MHz Separation,  $V_{CC}=3$  V

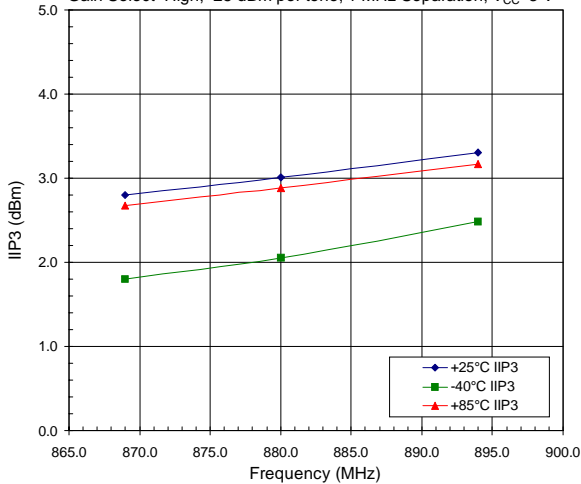

### LNA1 Input IP3 versus Supply Voltage

Gain Select=High, 880/881 MHz, -25 dBm per tone

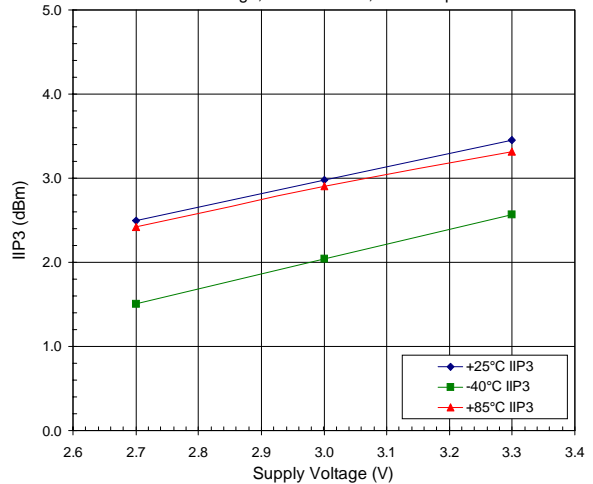

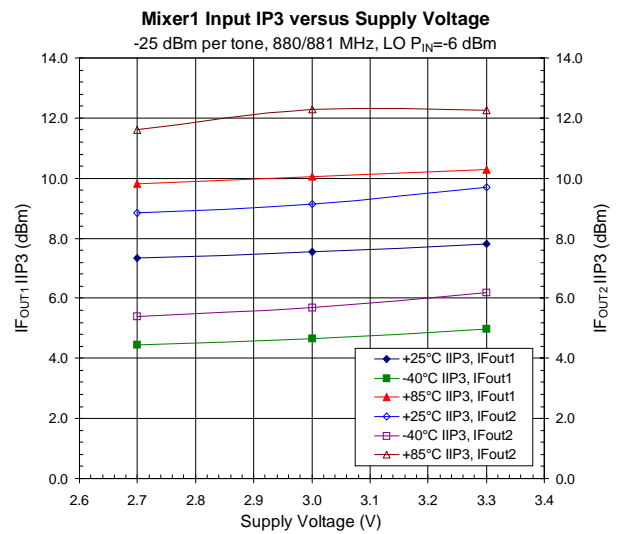
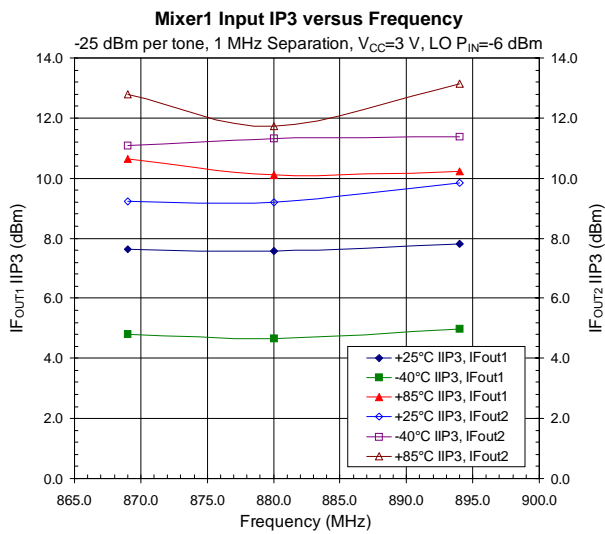
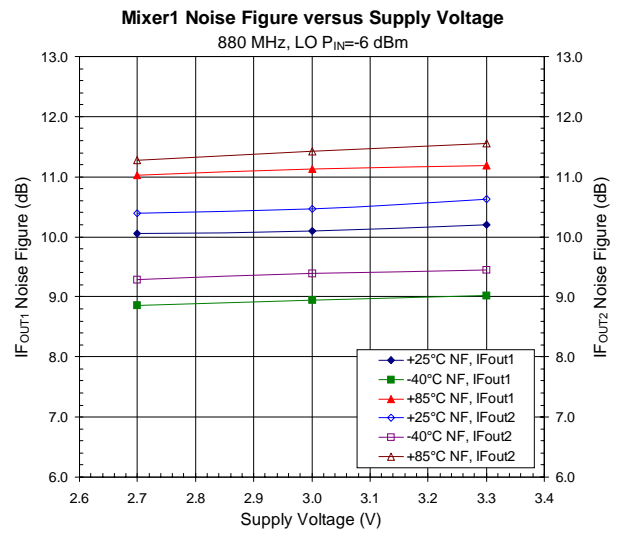
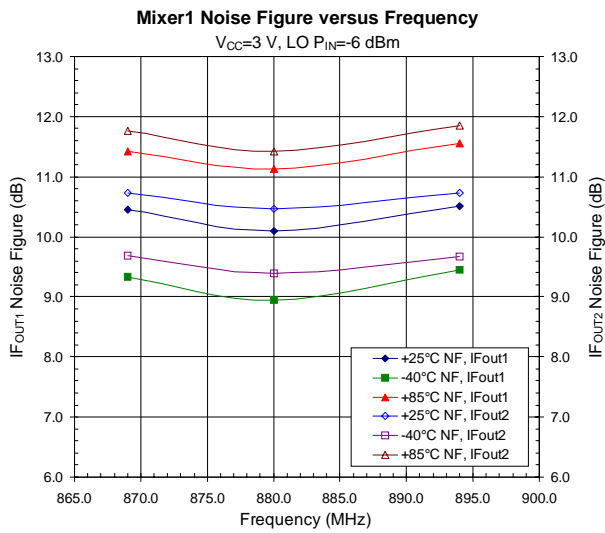
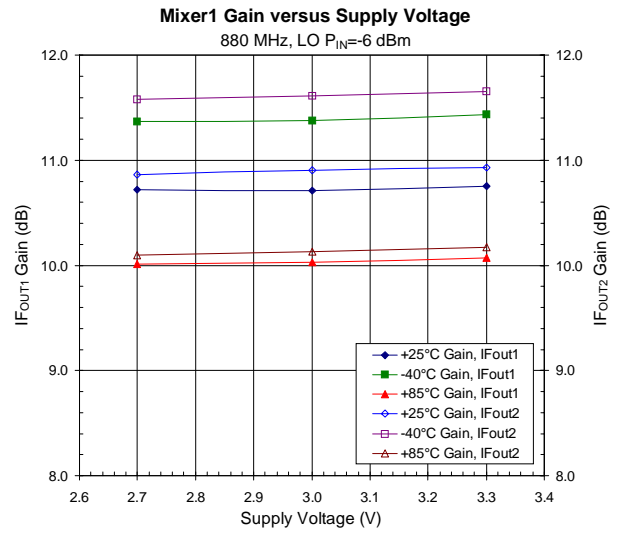
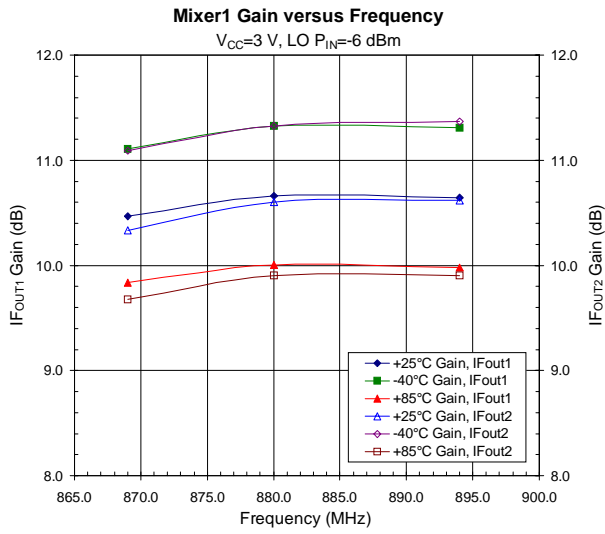

### LNA2 Gain versus Frequency

Gain Select=High,  $V_{CC}=3$  V

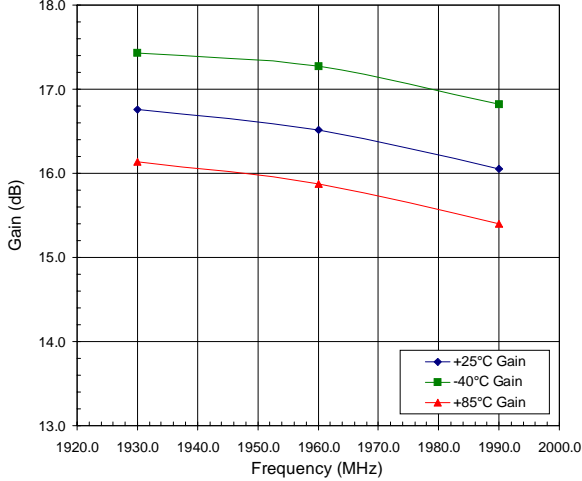

### LNA2 Gain versus Supply Voltage

Gain Select=High, 1960 MHz

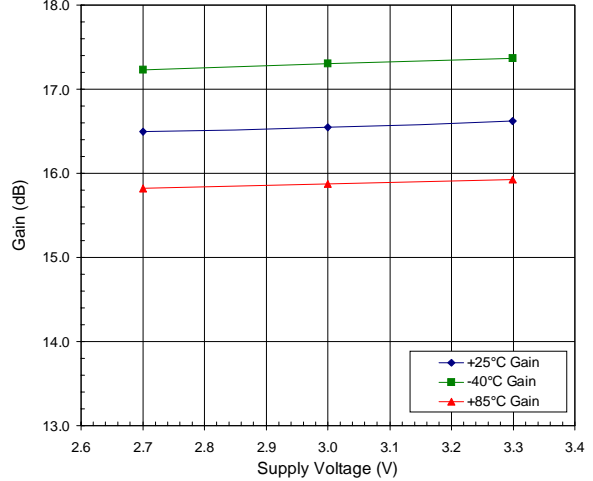

### LNA2 Noise Figure versus Frequency

Gain Select=High,  $V_{CC}=3$  V

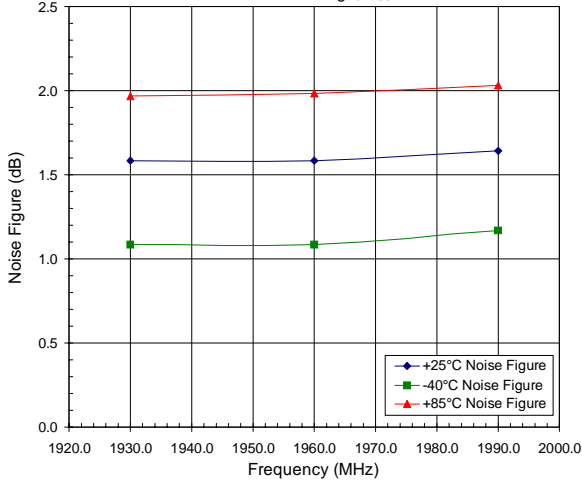

### LNA2 Noise Figure versus Supply Voltage

Gain Select=High, 1960 MHz

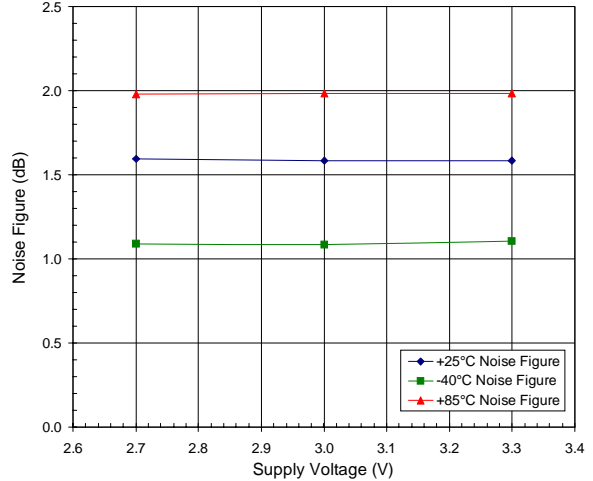

### LNA2 Input IP3 versus Frequency

Gain Select=High, -25 dBm per tone, 1 MHz Separation,  $V_{CC}=3$  V

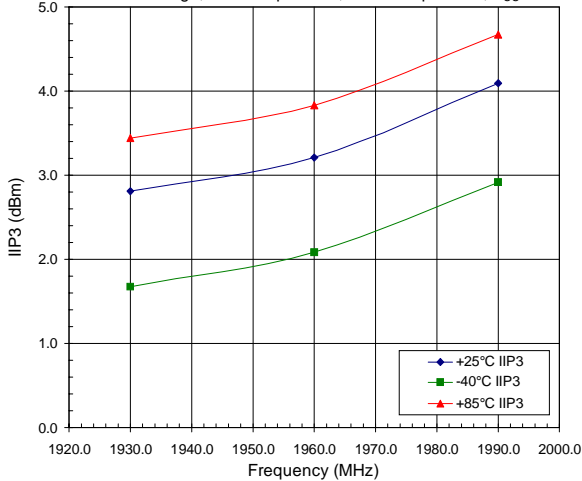

### LNA2 Input IP3 versus Supply Voltage

Gain Select=High, 1960/1961 MHz, -25 dBm per tone

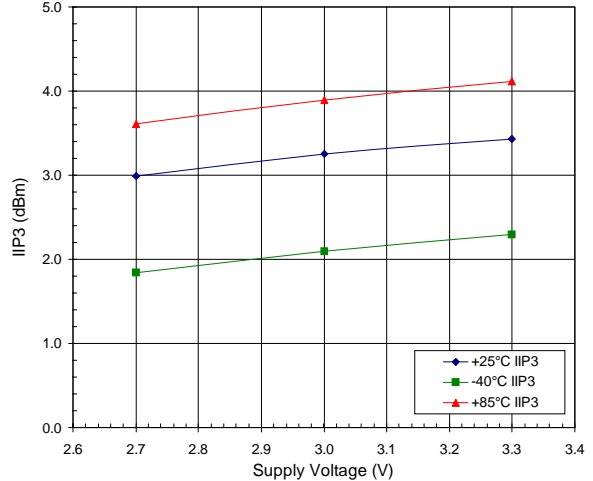



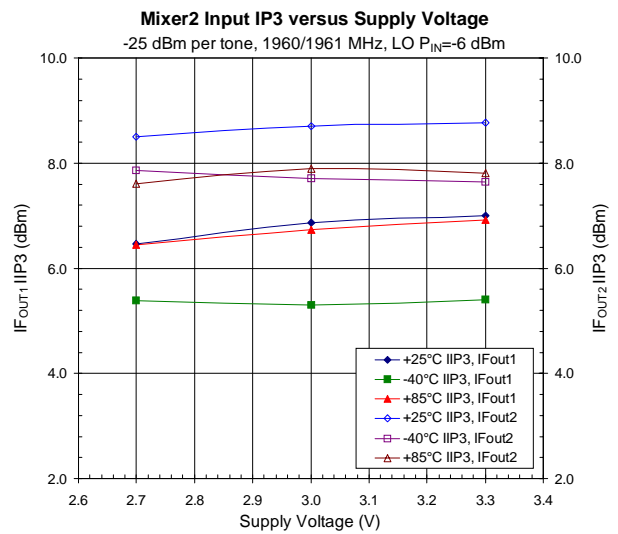
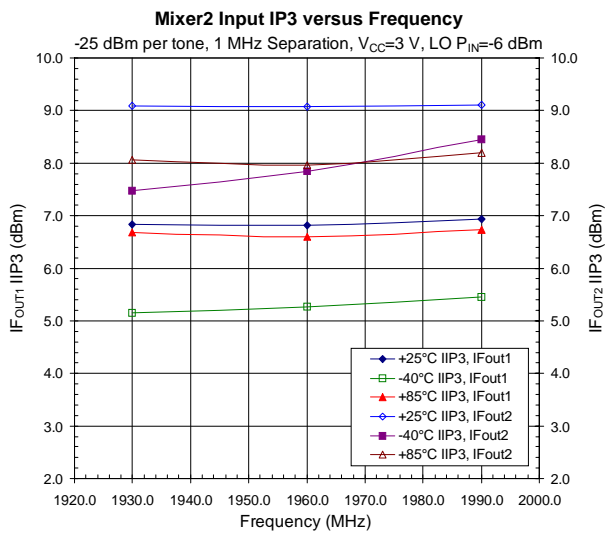
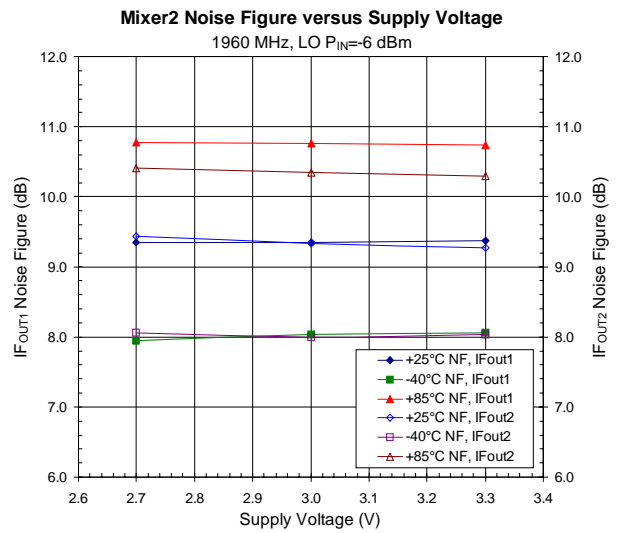
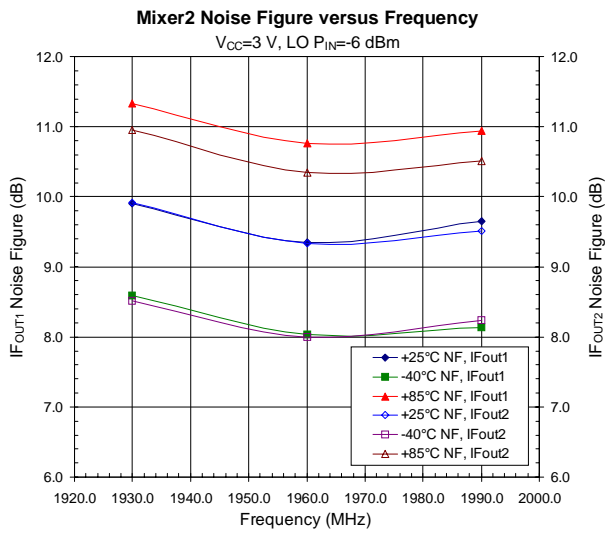
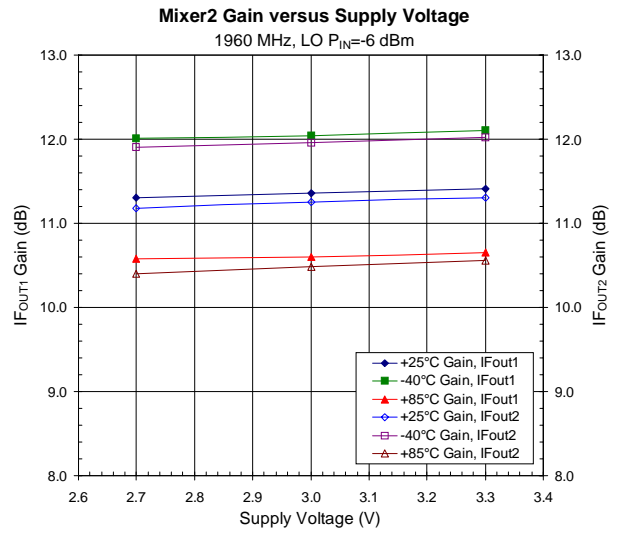
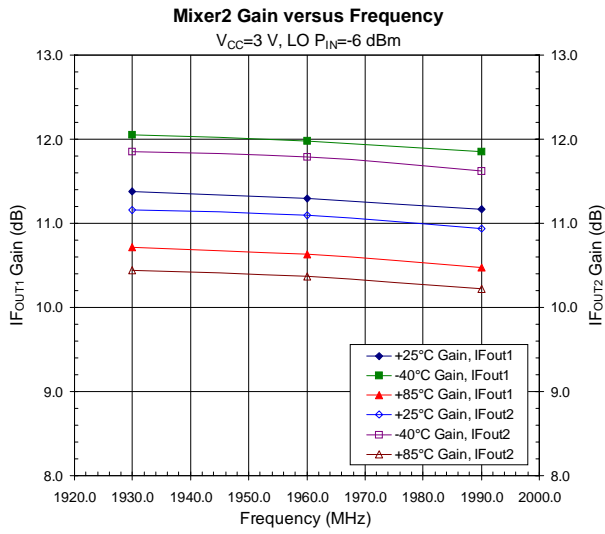

**LNA1+Mixer1 Gain versus Frequency**

Gain Select=High,  $V_{CC}=3\text{ V}$ ,  $LO\ P_{IN}=-6\text{ dBm}$

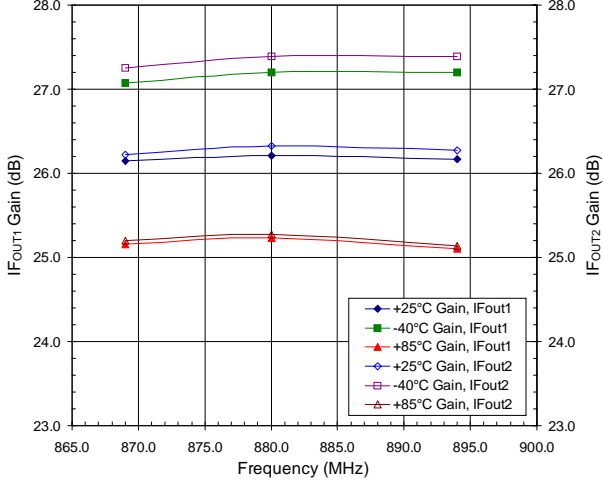

**LNA1+Mixer1 Gain versus Supply Voltage**

Gain Select=High, 880 MHz,  $LO\ P_{IN}=-6\text{ dBm}$

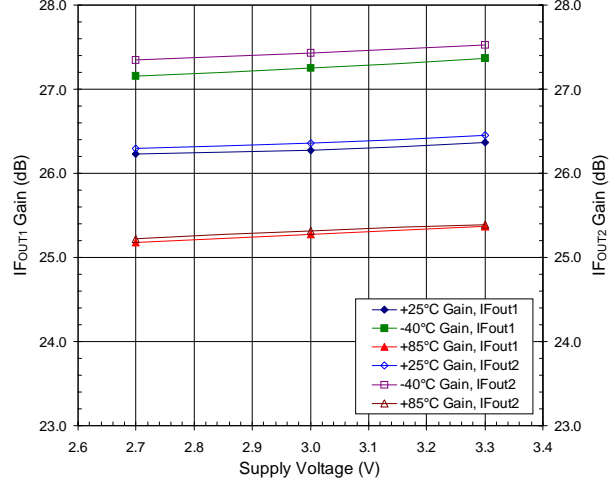

**LNA1+Mixer1 Noise Figure versus Frequency**

Gain Select=High,  $V_{CC}=3\text{ V}$ ,  $LO\ P_{IN}=-6\text{ dBm}$

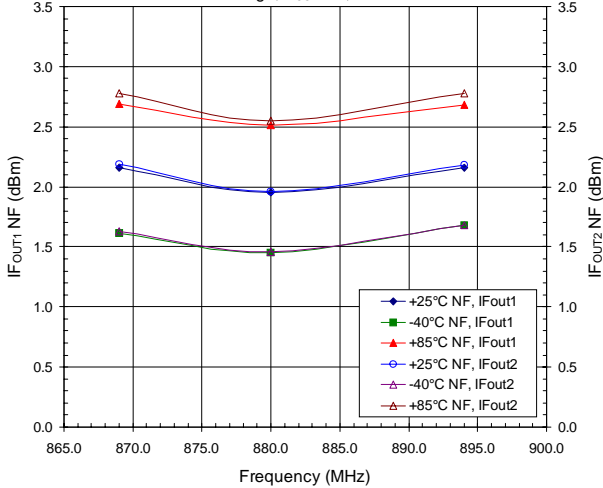

**LNA1+Mixer1 Noise Figure versus Supply Voltage**

Gain Select=High, 880 MHz,  $LO\ P_{IN}=-6\text{ dBm}$

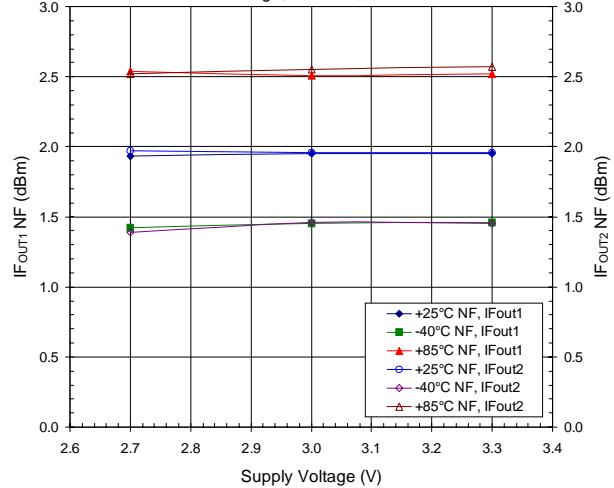

**LNA1+Mixer1 Input IP3 versus Frequency**

Gain Select=High, -40 dBm per tone, 1 MHz Separation,  $V_{CC}=3\text{ V}$ ,  $LO=-6\text{ dBm}$

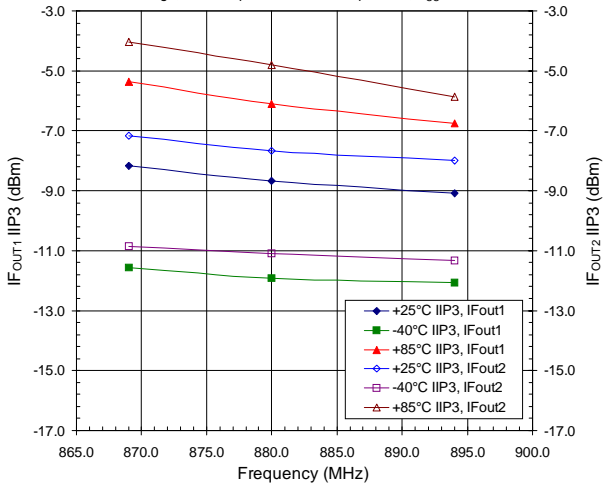

**LNA1+Mixer1 Input IP3 versus Supply Voltage**

Gain Select=High, 880/881 MHz, -40 dBm per tone,  $LO=-6\text{ dBm}$

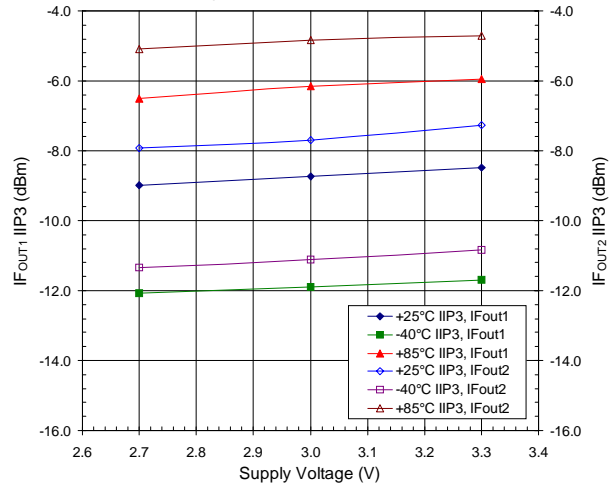

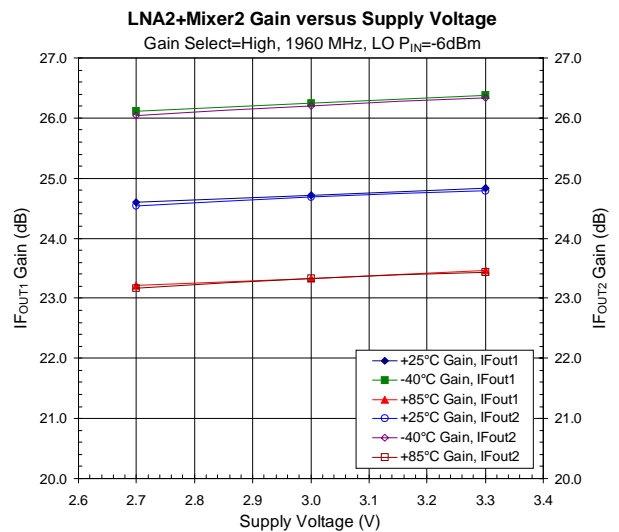
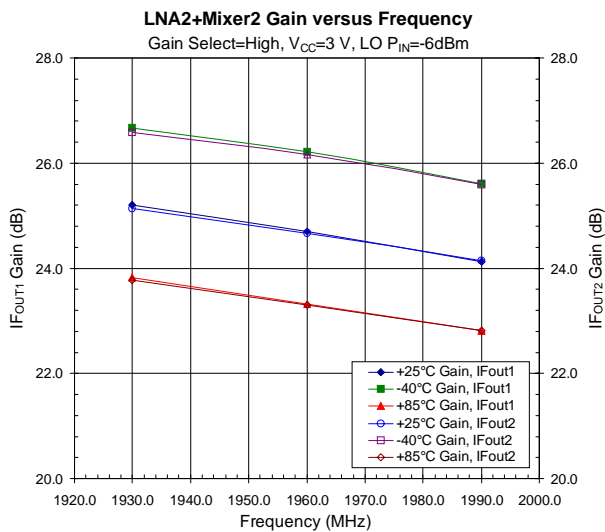
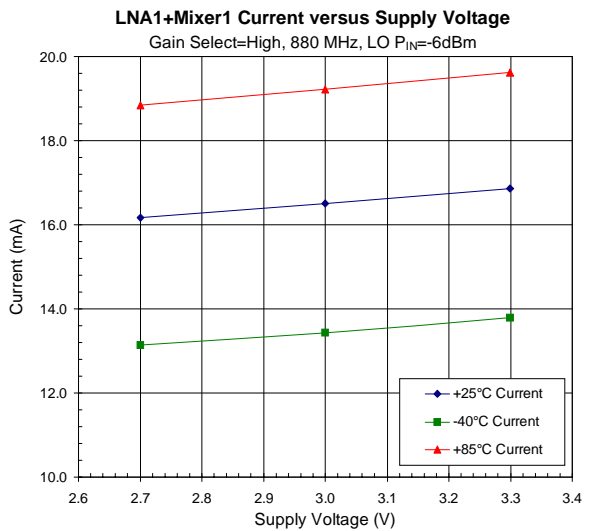
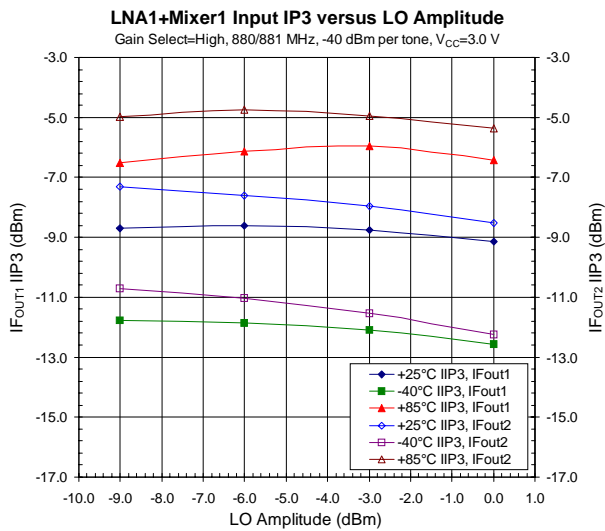
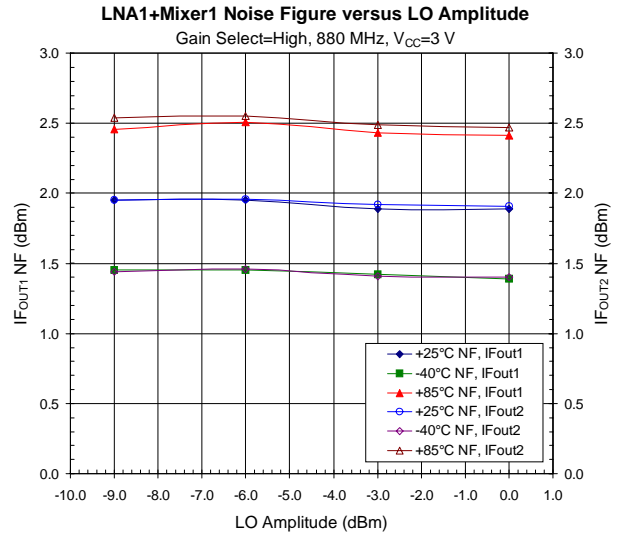
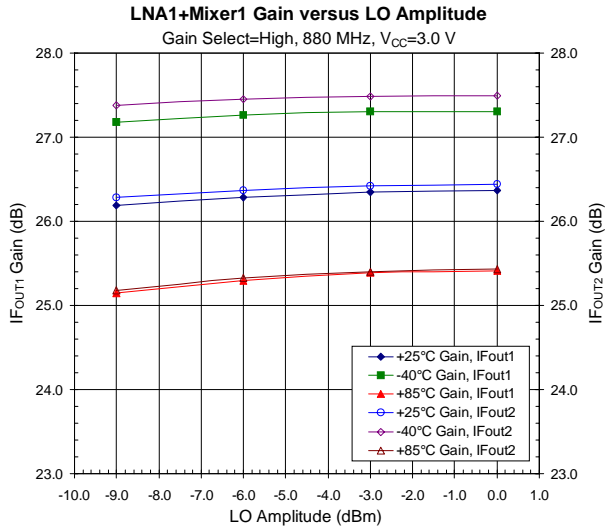

**LNA2+Mixer2 Noise Figure versus Frequency**

Gain Select=High,  $V_{CC}=3\text{ V}$ ,  $LO\ P_{IN}=6\text{ dBm}$

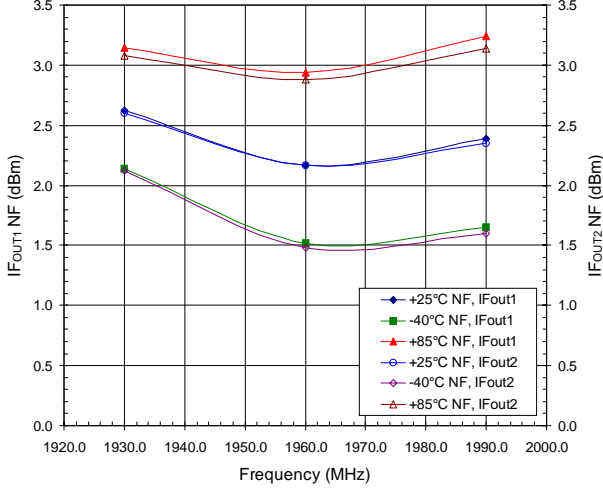

**LNA2+Mixer2 Noise Figure versus Supply Voltage**

Gain Select=High, 1960 MHz,  $LO\ P_{IN}=6\text{ dBm}$

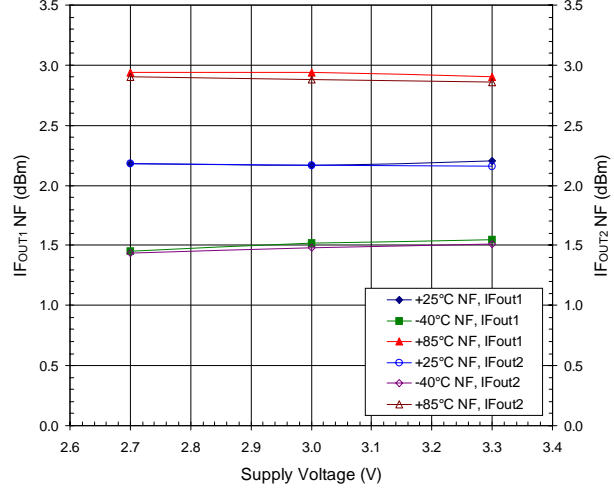

**LNA2+Mixer2 Input IP3 versus Frequency**

Gain Select=High, -40 dBm per tone, 1 MHz Separation,  $V_{CC}=3\text{ V}$ ,  $LO=-6\text{ dBm}$

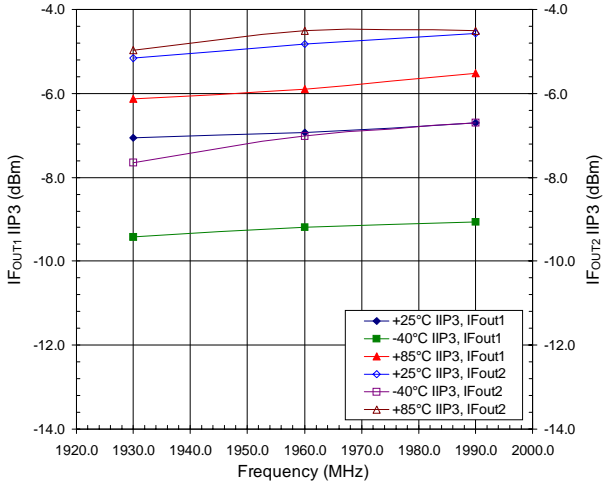

**LNA2+Mixer2 Input IP3 versus Supply Voltage**

Gain Select=High, 1960/1961 MHz, -40 dBm per tone,  $LO=-6\text{ dBm}$

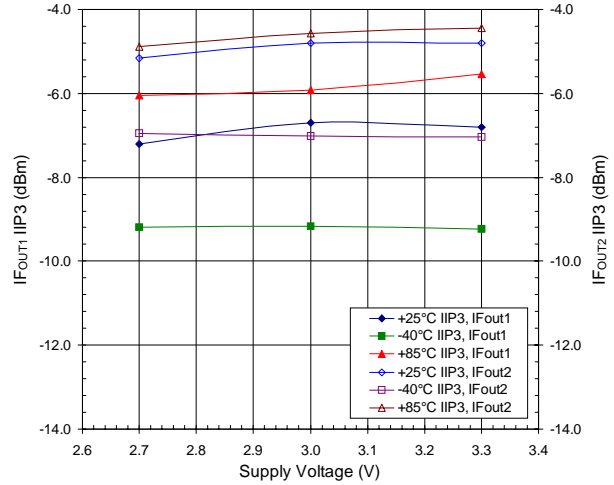

**LNA2+Mixer2 Gain versus LO Amplitude**

Gain Select=High, 1960 MHz,  $V_{CC}=3.0\text{ V}$

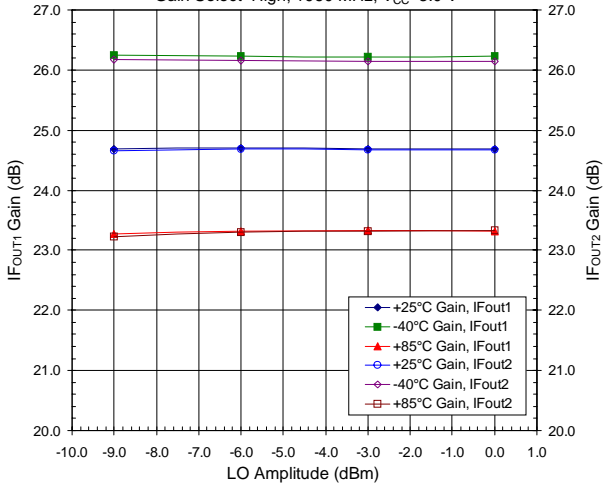

**LNA2+Mixer2 Noise Figure versus LO Amplitude**

Gain Select=High, 1960 MHz,  $V_{CC}=3\text{ V}$

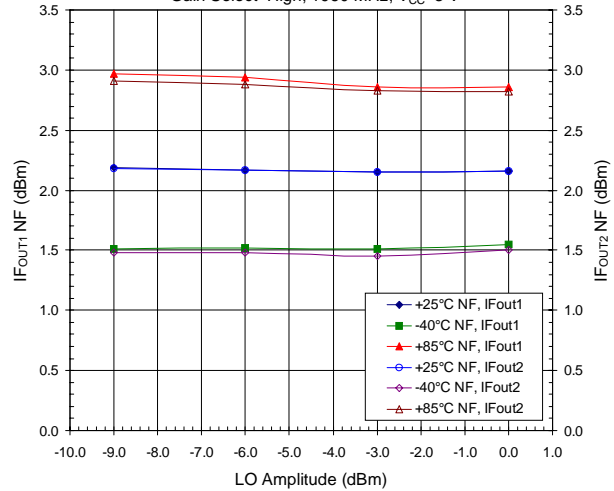

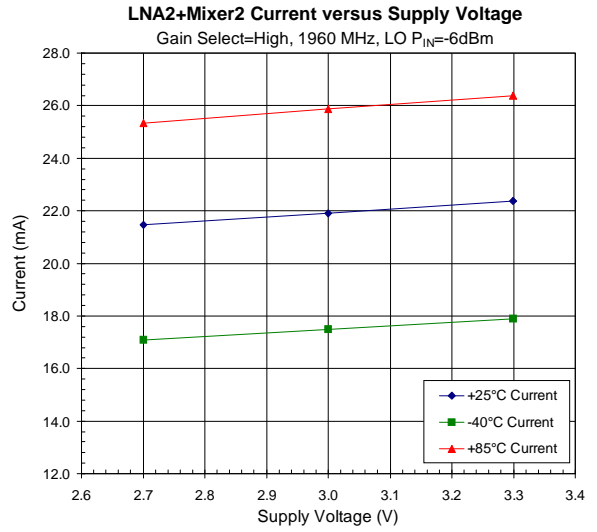
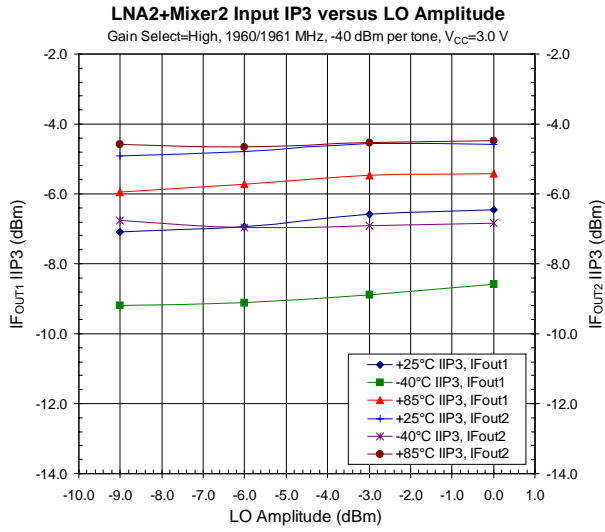

**RF2488**

*Preliminary*

∞

FRONT-ENDS