

Dual, Low-Noise, 200mA LDO Regulator

General Description

The RT9182 is a dual-channel, low noise, and low dropout regulator supplying up to 200mA current at each channel. The output voltage ranges from 1.5V to 3.3V in 100mV increments and 2% accuracy by operating from a +2.7V to +6.5V input.

The RT9182 uses an internal PMOS as the pass device, which consumes 165µA supply current (both LDOs on) independent of load current and dropout conditions. The $\overline{\text{SHDN}}$ pin controls both outputs simultaneously and consumes nearly zero operation current in the disable mode making the IC suitable for battery-power devices. Other features include a reference voltage bypass pin to improve low noise performance, current limiting, and over temperature protection.

Ordering Information

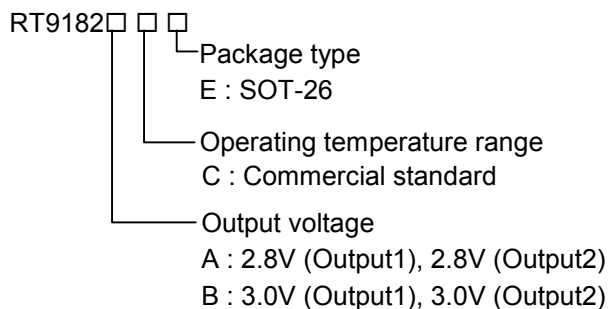

Marking Information

Part Number	Marking
RT9182ACE	2M
RT9182BCE	2Q

Features

- Up to 200mA Output Current (Each LDO)
- Shutdown Function
- 29µV_{RMS} Low Noise Output
- Current Limiting and Thermal Protection
- Short Circuit Protection
- 120mV Dropout at 100mA Load
- Two LDOs in SOT-26 Package

Applications

- Cellular Phones
- Laptop, Notebook, and Palmtop Computers
- Battery-powered Equipment
- Hand-held Equipment

Pin Configurations

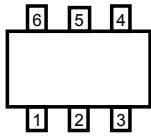
Part Number	Pin Configurations
RT9182□CE (Plastic SOT-26)	<div style="display: flex; align-items: center;">  <div style="margin-left: 20px;"> <p>TOP VIEW</p> <ol style="list-style-type: none"> 1. VOUT2 2. GND 3. BP 4. $\overline{\text{SHDN}}$ 5. VIN 6. VOUT1 </div> </div>

Typical Application Circuit

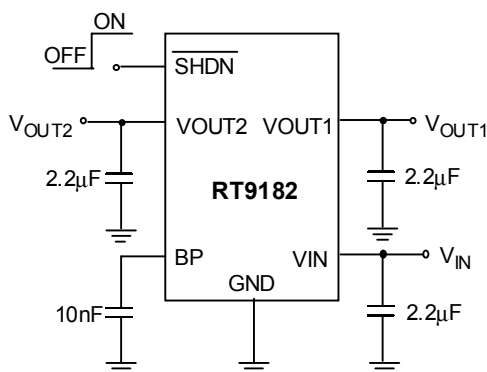

Pin Description

Pin Name	Pin Function
VOUT2	Output2 Voltage
GND	Ground
BP	Reference Noise Bypass
$\overline{\text{SHDN}}$	Active Low Shutdown Input
VIN	Power Input
VOUT1	Output1 Voltage

Function Block Diagram

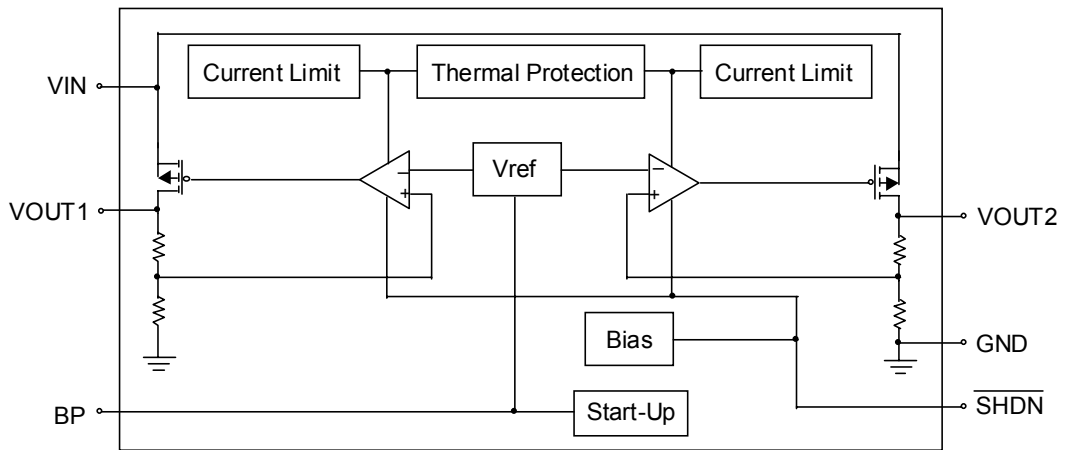

Absolute Maximum Ratings

- Input Voltage 7V
- Power Dissipation, P_D @ $T_A = 25^\circ\text{C}$
SOT-26 748mW
- Junction Temperature Range $-40^\circ\text{C} \sim 125^\circ\text{C}$
- Storage Temperature Range $-65^\circ\text{C} \sim 150^\circ\text{C}$
- Operating Temperature Range $-40^\circ\text{C} \sim 85^\circ\text{C}$
- Lead Temperature (Soldering, 10 sec.) 260°C

Electrical Characteristics

($V_{IN} = 3.6\text{V}$, $C_{IN} = C_{OUT} = 2.2\mu\text{F}$, $\overline{\text{SHDN}} = V_{IN}$, typical values at $T_A = 25^\circ\text{C}$, for each LDO unless otherwise specified.)

Parameter	Symbol	Test Conditions	Min	Typ	Max	Units
Input Voltage Range	V_{IN}		2.7	--	6.5	V
Output Voltage Accuracy (Load Regulation)	ΔV_{OUT}	$I_L = 1\text{mA to } 200\text{mA}$	-2	--	+2	%
Maximum Output Current	I_{MAX}	Continuous	200	--	--	mA
Current Limit	I_{LIMIT}	$R_{LOAD} = 1\Omega$	200	--	550	mA
GND Pin Current	I_G	No Load	--	165	260	μA
		$I_{OUT} = 100\text{mA}$ (Both LDOs)	--	165	260	μA
Dropout Voltage (Note)	V_{DROP}	$I_{OUT} = 1\text{mA}$	--	1.2	--	mV
		$I_{OUT} = 100\text{mA}$	--	120	--	mV
		$I_{OUT} = 200\text{mA}$	--	255	--	mV
Line Regulation	ΔV_{LINE}	$V_{IN} = (V_{OUT} + 0.4\text{V or } 2.7\text{V}) \text{ to } 6.5\text{V}$ $I_{OUT} = 1\text{mA}$	-0.2	--	+0.2	%/V
$\overline{\text{SHDN}}$ Input High Threshold	V_{IH}	$V_{IN} = 2.7\text{V to } 6.5\text{V}$	1.6	--	--	V
$\overline{\text{SHDN}}$ Input Low Threshold	V_{IL}	$V_{IN} = 2.7\text{V to } 6.5\text{V}$	--	--	0.4	V
$\overline{\text{SHDN}}$ Input Bias Current	I_{SD}	$\overline{\text{SHDN}} = \text{GND or } V_{IN}$	--	--	100	nA
Shutdown Supply Current	I_{GSD}	$\overline{\text{SHDN}} = \text{GND}$	--	0.01	1	μA
Thermal Shutdown Temperature			--	140	--	$^\circ\text{C}$
Thermal Shutdown Hysteresis	T_{SD}		--	10	--	$^\circ\text{C}$
Output Voltage Noise	e_{NO}	10Hz to 100kHz, $C_{BP} = 10\text{nF}$ $C_{OUT} = 4.7\mu\text{F}$, $I_{LOAD} = 1\text{mA}$	--	29	--	μVRMS
Output Voltage AC PSRR		100Hz, $C_{BP} = 10\text{nF}$, $C_{OUT} = 4.7\mu\text{F}$ $I_{LOAD} = 100\text{mA}$	--	62	--	dB

Note : Dropout voltage definition: $V_{IN} - V_{OUT}$ when V_{OUT} is 50mV below the value of V_{OUT} (normal)

Typical Operating Characteristics

$V_{OUT} = 2.8V$, $I_{LOAD} = 100mA$, $V_{IN} = 3.6V$, $C_{OUT} = 4.7\mu F$, $C_{BP} = 10nF$, and $C_{IN} = 2.2\mu F$, unless otherwise noted.

Quiescent Current vs. Supply Voltage

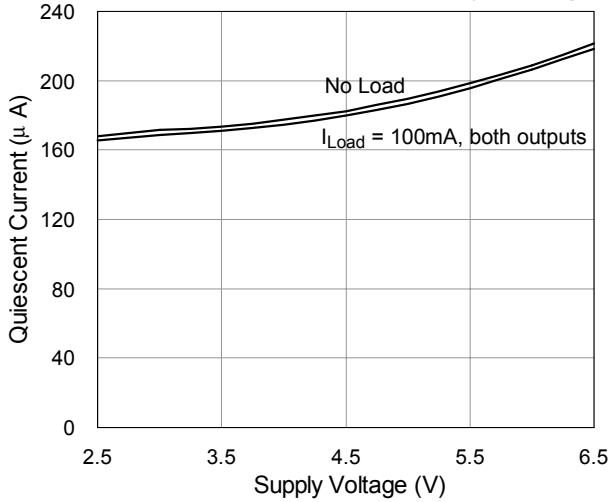

Output Voltage Accuracy vs. Temp.

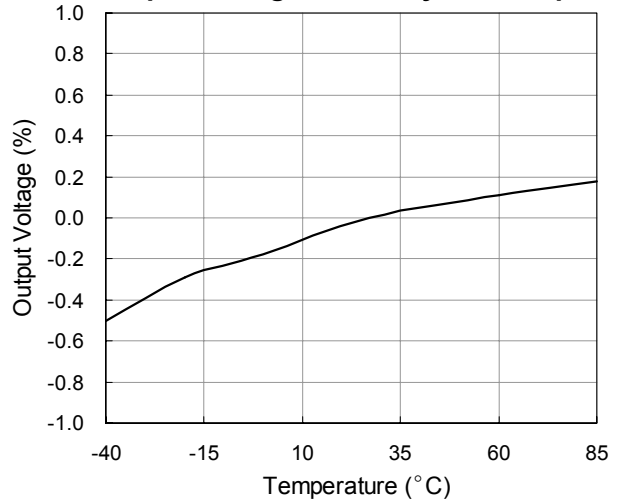

Quiescent Current vs. Load Current

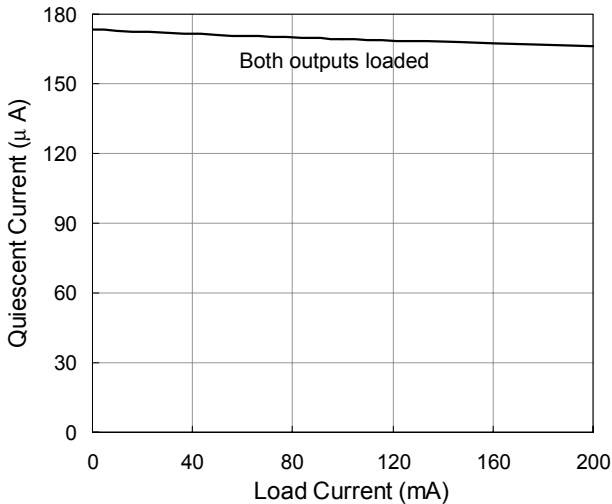

Dropout Voltage vs. Temp.

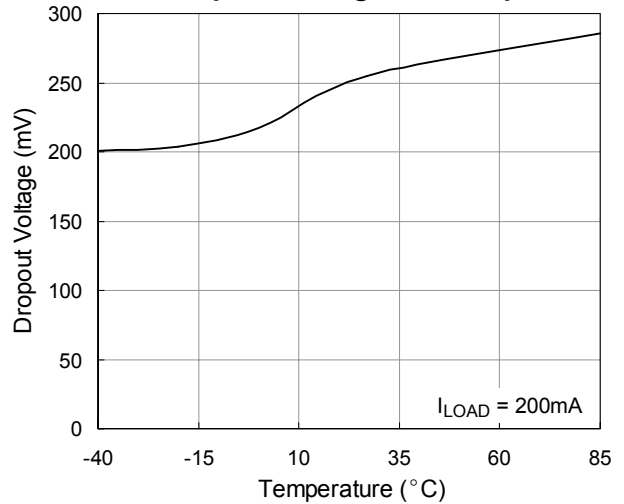

Quiescent Current vs. Temp.

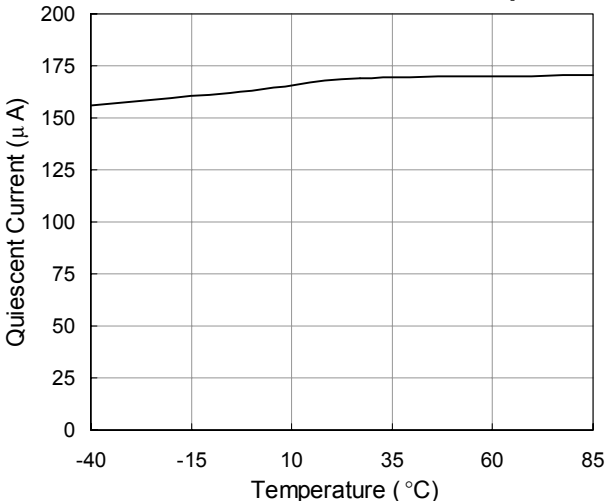

PSRR vs. Frequency

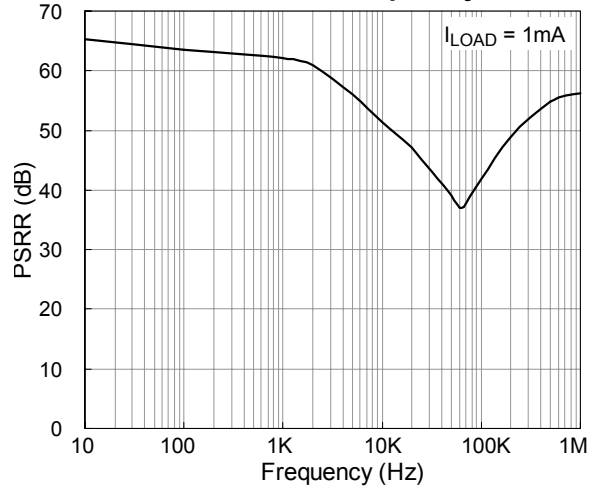

Channel-to-Channel Isolation vs. Frequency

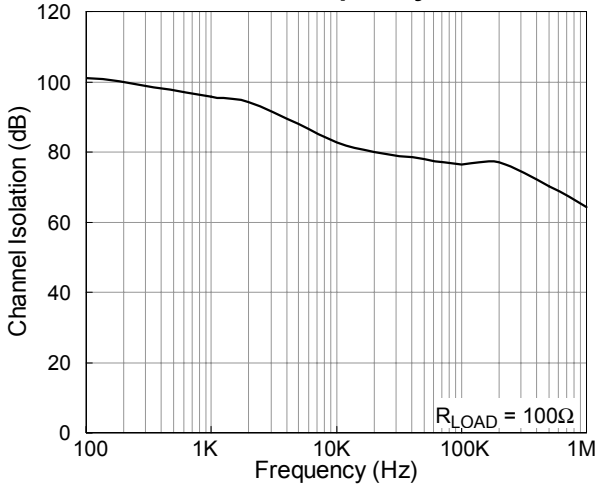

Noise Density vs. Frequency

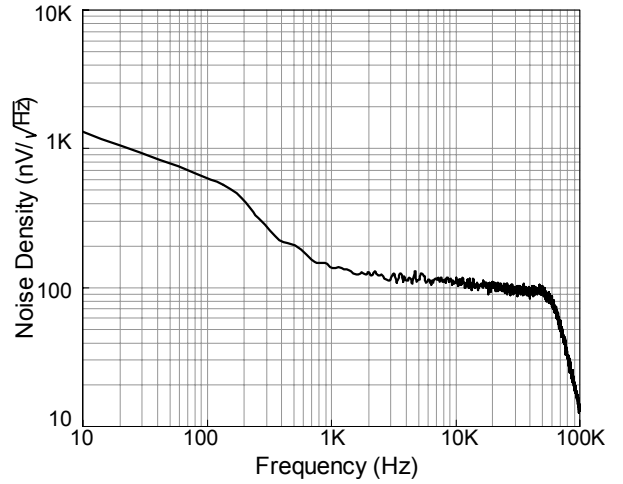

Line Transient Response

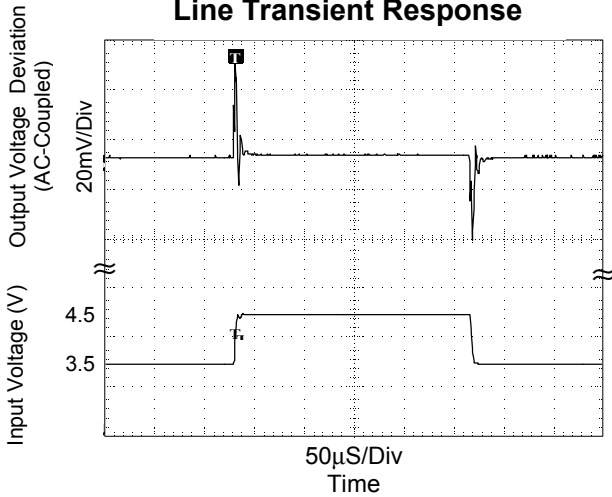

Load Transient Response (I_LOAD = 0 to 80mA)

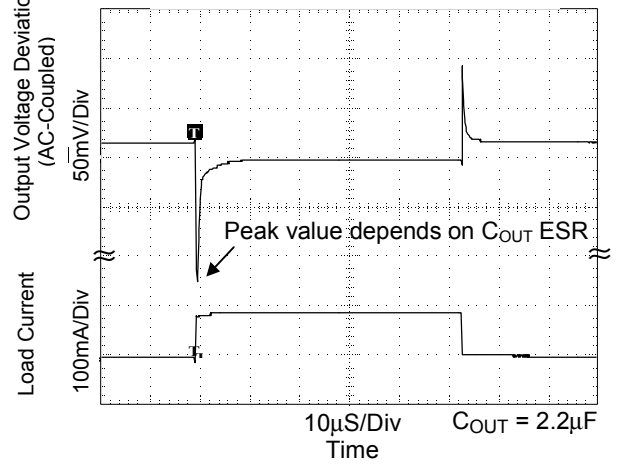

Shutdown Response

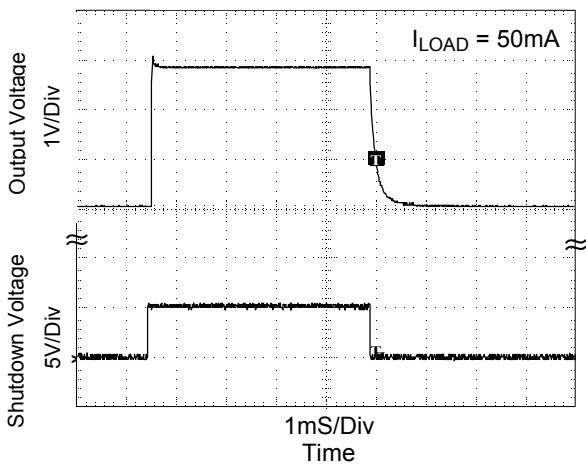

Output Noise (10Hz to 100kHz)

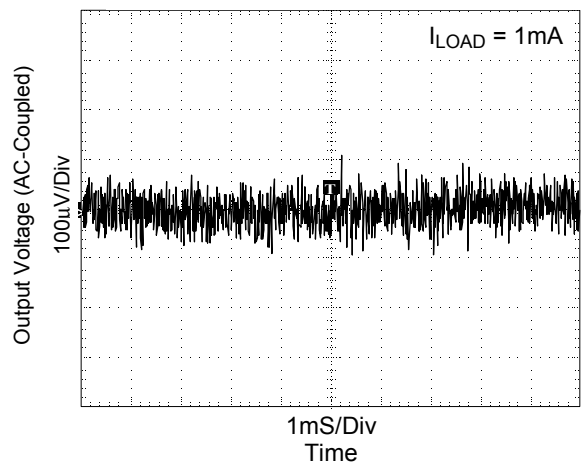

Functional Description

The RT9182 is integrated with two low noise, low dropout, and low quiescent current linear regulators designed primarily for battery-powered applications. Output voltages are optional ranging from 1.5V to 3.3V, and each channel can supply current up to 200mA.

Shutdown

The RT9182 is shutdown by pulling the $\overline{\text{SHDN}}$ input low, and turned on by driving the input high. If this feature is not to be used, the $\overline{\text{SHDN}}$ input should be tied to VIN to keep the regulator on at all times (the $\overline{\text{SHDN}}$ input must **not** be left floating).

Internal P-Channel Pass Transistor

The RT9182 features double typical 1.5Ω P-channel MOSFET pass transistors. It provides several advantages over similar designs using PNP pass transistors, including longer battery life. The P-channel MOSFET requires no base drive, which reduces quiescent current considerably. PNP-based regulators waste considerable current in dropout when the pass transistor saturates. They also use high base-drive currents under large loads. The RT9182 does not suffer from these problems and consume only $165\mu\text{A}$ of quiescent current whether in dropout, light-load, or heavy-load applications.

Current Limit and Thermal Protection

The RT9182 includes two independent current limit structure which monitor and control each pass transistor's gate voltage limiting the guaranteed maximum output current to 200mA minimum.

Thermal-overload protection limits total power dissipation in the RT9182. When the junction temperature exceeds $T_J = +140^\circ\text{C}$, the thermal sensor signals the shutdown logic turning off the pass transistor and allowing the IC to cool. The thermal sensor will turn the pass transistor on again after the IC's junction temperature cools by 10°C , resulting in a pulsed output during continuous thermal-overload conditions. Thermal-overloaded protection is designed to protect the RT9182 in the

event of fault conditions. Do not exceed the absolute maximum junction-temperature rating of $T_J = +150^\circ\text{C}$ for continuous operation. The output can be shorted to ground for an indefinite amount of time without damaging the part by cooperation of current limit and thermal protection.

Operating Region and Power Dissipation

The maximum power dissipation of RT9182 depends on the thermal resistance of the case and circuit board, the temperature difference between the die junction and ambient air, and the rate of airflow. The power dissipation across the device is

$$P = I_{\text{OUT}} (V_{\text{IN}} - V_{\text{OUT}}).$$

The maximum power dissipation is:

$$P_{\text{MAX}} = (T_J - T_A) / \theta_{\text{JA}}$$

where $T_J - T_A$ is the temperature difference between the RT9182 die junction and the surrounding environment, θ_{JA} is the thermal resistance from the junction to the surrounding environment. The GND pin of the RT9182 performs the dual function of providing an electrical connection to ground and channeling heat away. Connect the GND pin to ground using a large pad or ground plane.

Low-Noise Operation

An external 10nF bypass capacitor at BP, in conjunction with an internal resistor, creates a lowpass filter. The RT9182 exhibits $29\mu\text{VRMS}$ of output voltage noise with $C_{\text{BP}} = 10\text{nF}$ and $C_{\text{OUT}} = 2.2\mu\text{F}$.

Applications Information

Capacitor Selection and Regulator Stability

Like any low-dropout regulator, the external capacitors used with the RT9182 must be carefully selected for regulator stability and performance.

Using a capacitor whose value is $> 1\mu\text{F}$ on the RT9182 input and the amount of capacitance can be increased without limit. The input capacitor must be located a distance of not more than 0.5" from the input pin of the IC and returned to a clean analog ground. Any good quality ceramic or tantalum can be used for this capacitor. The capacitor with larger value and lower ESR (equivalent series resistance) provides better PSRR and line-transient response.

The output capacitor must meet both requirements for minimum amount of capacitance and ESR in all LDO applications (see Fig.1). The RT9182 is designed specifically to work with low ESR ceramic output capacitor in space-saving and performance consideration. Using a ceramic capacitor whose value is at least $1\mu\text{F}$ with ESR is $> 5\text{m}\Omega$ on the RT9182 output ensures stability. The RT9182 still works well with output capacitor of other types due to the wide stable ESR range. Output capacitor of larger capacitance can reduce noise and improve load-transient response, stability, and PSRR. The output capacitor should be located not more than 0.5" from the V_{OUT} pin of the RT9182 and returned to a clean analog ground.

Note that some ceramic dielectrics exhibit large capacitance and ESR variation with temperature. It may be necessary to use $2.2\mu\text{F}$ or more to ensure stability at temperatures below -10°C in this case. Also, tantalum capacitors, $2.2\mu\text{F}$ or more may be needed to maintain capacitance and ESR in the stable region for strict application environment.

Tantalum capacitors maybe suffer failure due to surge current when it is connected to a low-impedance source of power (like a battery or very large capacitor). If a tantalum capacitor is used at the input, it must be guaranteed to have a surge current

rating sufficient for the application by the manufacture.

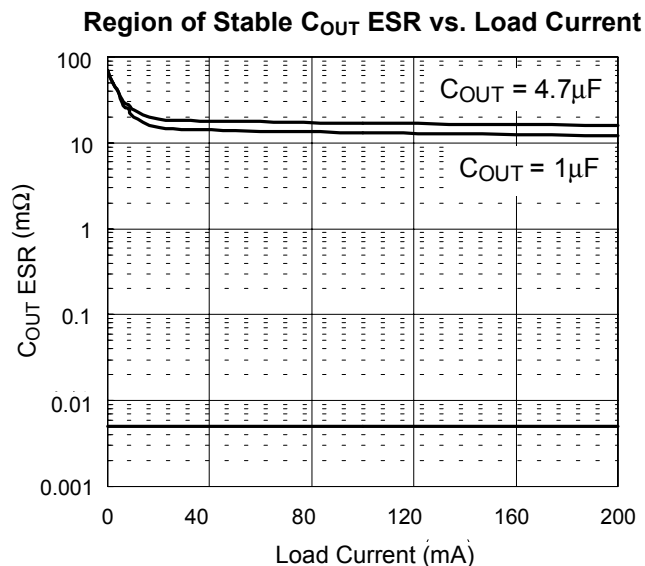

Fig. 1

Use a 10nF bypass capacitor at BP pin for low output voltage noise. The capacitor, in conjunction with an internal resistor, which connects bypass pin and the band-gap reference, creates a low-pass filter for noise reduction. Increasing the capacitance will slightly decrease the output noise, and it is almost independent of the start-up time. The capacitor connected to the bypass pin for noise reduction must have very low leakage. This capacitor leakage current causes the output voltage to decline by a proportional amount to the current.

Load-Transient Considerations

The RT9182 load-transient response graphs show two components of the output response: a DC shift from the output impedance due to the load current change, and the transient response. The DC shift is quite small due to the excellent load regulation of the IC. Typical output voltage transient spike for a step change in the load current from 0mA to 50mA is tens mV, depending on the ESR of the output capacitor. Increasing the output capacitor's value and decreasing the ESR attenuates the overshoot.

Input-Output (Dropout) Voltage

A regulator’s minimum input-output voltage differential (or dropout voltage) determines the lowest usable supply voltage. In battery-powered systems, this will determine the useful end-of-life battery voltage. Because the RT9182 uses a P-channel MOSFET pass transistor, the dropout voltage is a function of drain-to-source on-resistance [$R_{DS(ON)}$] multiplied by the load current.

Reverse Current Path

The power transistor used in the RT9182 has an inherent diode connected between each regulator input and output (see Fig.2). If the output is forced above the input by more than a diode-drop, this diode will become forward biased and current will flow from the V_{OUT} terminal to V_{IN} . This diode will also be turned on by abruptly stepping the input voltage to a value below the output voltage. To prevent regulator mis-operation, a Schottky diode could be used in the applications where input/output voltage conditions can cause the internal diode to be turned on (see Fig.3). As shown, the Schottky diode is connected in parallel with the internal parasitic diode and prevents it from being turned on by limiting the voltage drop across it to about $0.3V < 100mA$ to prevent damage to the part.

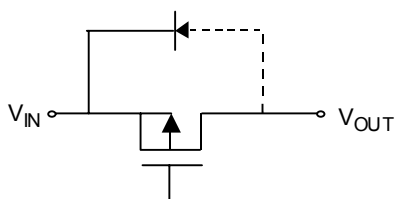

Fig. 2

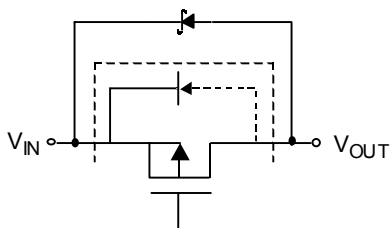
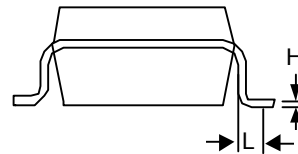
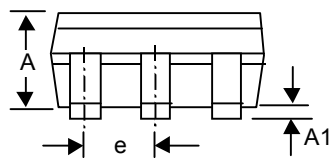
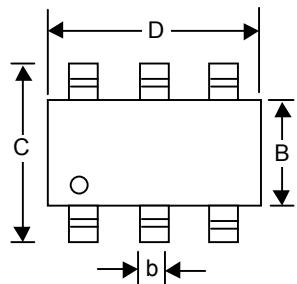

Fig. 3

Package Information



Symbol	Dimensions In Millimeters		Dimensions In Inches	
	Min	Max	Min	Max
A	0.889	1.295	0.035	0.051
A1	--	0.152	--	0.006
B	1.397	1.803	0.055	0.071
b	0.356	0.559	0.014	0.022
C	2.591	2.997	0.102	0.118
D	2.692	3.099	0.106	0.122
e	0.838	1.041	0.033	0.041
H	0.102	0.254	0.004	0.010
L	0.356	0.610	0.014	0.024

SOT- 26 Surface Mount Package

RICHTEK TECHNOLOGY CORP.

Headquarter

6F, No. 35, Hsintai Road, Chupei City

Hsinchu, Taiwan, R.O.C.

Tel: (8863)5510047 Fax: (8863)5537749

RICHTEK TECHNOLOGY CORP.

Taipei Office (Marketing)

8F-1, No. 137, Lane 235, Paochiao Road, Hsintien City

Taipei County, Taiwan, R.O.C.

Tel: (8862)89191466 Fax: (8862)89191465

Email: marketing@richtek-ic.com.tw