

# High Voltage Switching Transistor (400V, 2A)

## 2SC3969 / 2SC5161

●Features

- 1) Low  $V_{CE(sat)}$ .  
 $V_{CE(sat)} = 0.15V$  (Typ.)  
 $(I_C / I_B = 1A / 0.2A)$
- 2) High breakdown voltage.  
 $V_{CEO} = 400V$
- 3) Fast switching.  
 $t_r = 1.0\mu s$   
 $(I_C = 0.8A)$

●Structure

Three-layer, diffused planar type  
 NPN silicon transistor

●External dimensions (Units: mm)

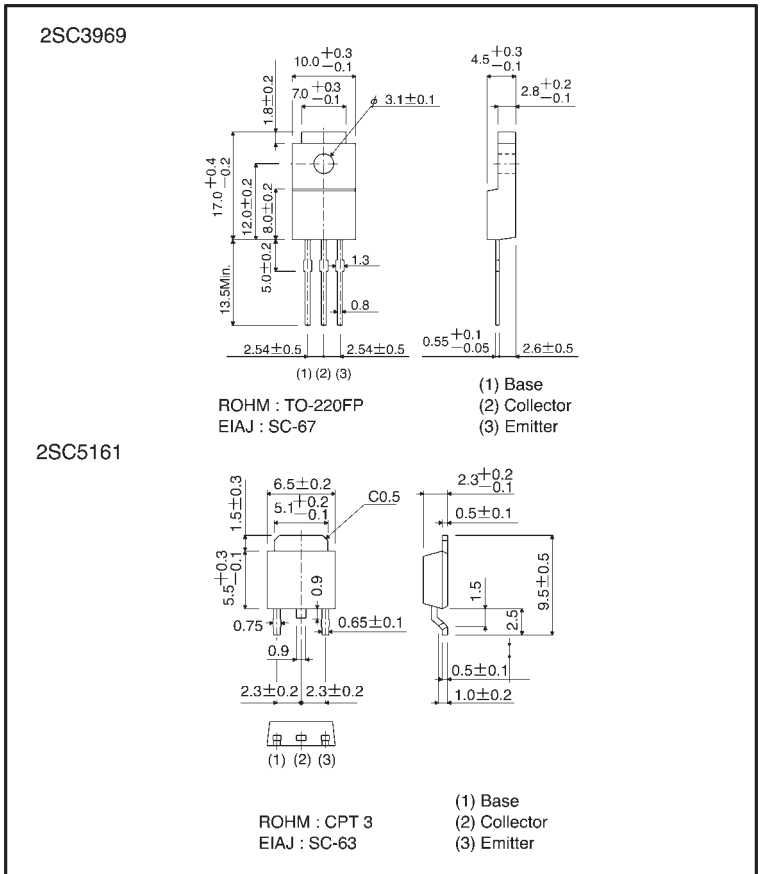

## ● Absolute maximum ratings (Ta = 25°C)

Parameter		Symbol	Limits	Unit
Collector-base voltage		V <sub>CBO</sub>	400	V
Collector-emitter voltage		V <sub>CEO</sub>	400	V
Emitter-base voltage		V <sub>EBO</sub>	7	V
Collector current		I <sub>C</sub>	2	A (DC)
		I <sub>CP</sub>	4	A (Pulse) *
Collector power dissipation	2SC3969	P <sub>C</sub>	2	W
			20	W(T <sub>C</sub> =25°C)
	2SC5161		1	W
			10	W(T <sub>C</sub> =25°C)
Junction temperature		T <sub>J</sub>	150	°C
Storage temperature		T <sub>stg</sub>	-55~+150	°C

\* Single pulse P<sub>w</sub>=10ms

## ● Electrical characteristics (Ta = 25°C)

Parameter	Symbol	Min.	Typ.	Max.	Unit	Conditions
Collector-base breakdown voltage	BV <sub>CBO</sub>	400	—	—	V	I <sub>C</sub> =50 μA
Collector-emitter breakdown voltage	BV <sub>CEO</sub>	400	—	—	V	I <sub>C</sub> =1mA
Collector-emitter voltage	V <sub>CEO(SUS)</sub>	400	—	—	V	I <sub>C</sub> =1.0A, I <sub>B1</sub> =0.1A, L=1mH *2
Emitter-base breakdown voltage	BV <sub>EBO</sub>	7	—	—	V	I <sub>E</sub> =50 μA
Collector cutoff current	I <sub>CBO</sub>	—	—	10	μA	V <sub>CB</sub> =400V
Emitter cutoff current	I <sub>EBO</sub>	—	—	10	μA	V <sub>EB</sub> =7V
Collector-emitter saturation voltage	V <sub>CE(sat)</sub>	—	—	1	V	I <sub>C</sub> /I <sub>B</sub> =1A/0.2A
Base-emitter saturation voltage	V <sub>BE(sat)</sub>	—	—	1.5	V	I <sub>C</sub> /I <sub>B</sub> =1A/0.2A
DC current transfer ratio	h <sub>FE</sub>	25	—	50	—	V <sub>CE</sub> =5V, I <sub>C</sub> =0.1A
Transition frequency	f <sub>r</sub>	—	10	—	MHz	V <sub>CE</sub> =10V, I <sub>E</sub> =-0.1A, f=5MHz *1
Output capacitance	C <sub>ob</sub>	—	30	—	pF	V <sub>CB</sub> =10V, I <sub>E</sub> =0A, f=1MHz
Turn-on time	t <sub>ON</sub>	—	—	1	μs	I <sub>C</sub> =0.8A, R <sub>L</sub> =250 Ω
Storage time	t <sub>stg</sub>	—	—	2.5	μs	I <sub>B1</sub> =-I <sub>B2</sub> =0.08A V <sub>CC</sub> =200V
Fall time	t <sub>f</sub>	—	—	1	μs	Refer to measurement circuit diagram

\*1 Measured using pulse current

\*2 2SC3969

● Packaging specifications and h<sub>FE</sub>

Type	h <sub>FE</sub>	Package name	Bulk	Taping
		Code		TL
		Basic ordering unit (pieces)	500	2500
2SC3969	B		○	—
2SC5161	B		—	○

h<sub>FE</sub> values are classified as follows :

Item	B
h <sub>FE</sub>	25~50

●Electrical characteristic curves

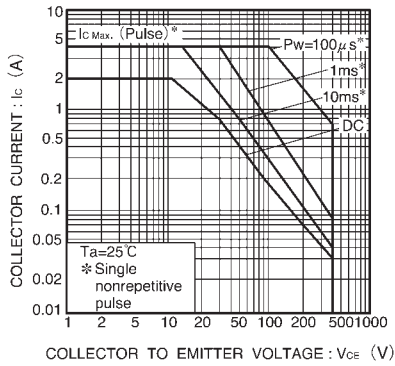

Fig.1 Safe operating area (2SC3969)

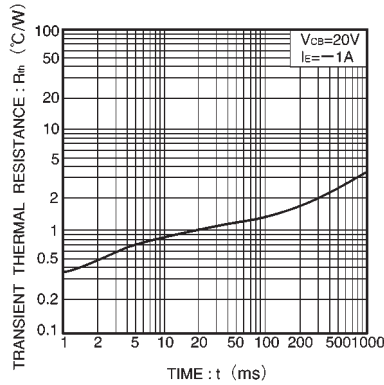

Fig.2 Transient thermal resistance (2SC3969)

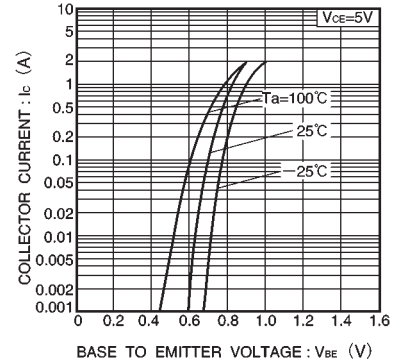

Fig.3 Grounded emitter propagation characteristics

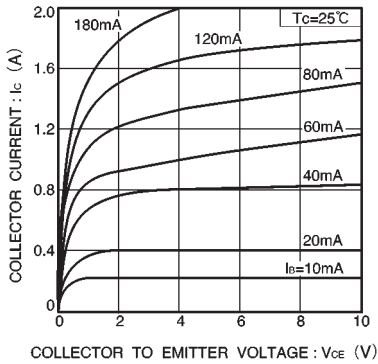

Fig.4 Grounded emitter output characteristics

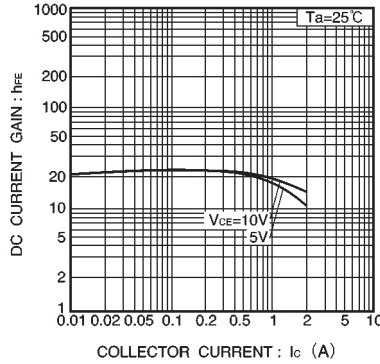

Fig.5 DC current gain vs. collector current ( I )

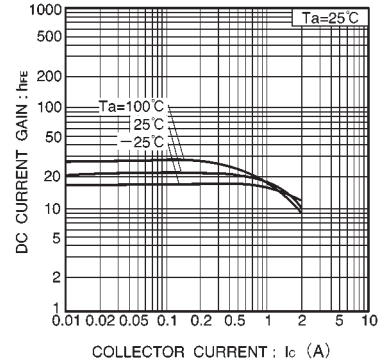

Fig.6 DC current gain vs. collector current ( II )

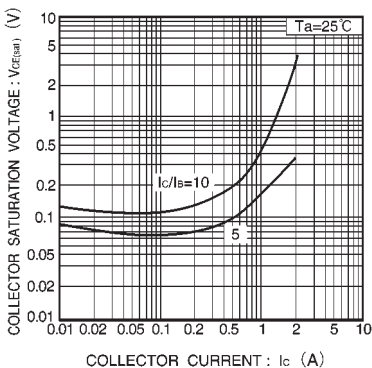

Fig.7 Collector-emitter saturation voltage vs. collector current

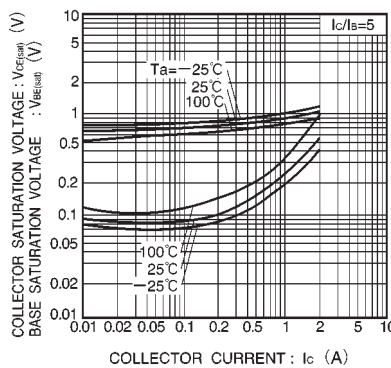

Fig.8 Collector-emitter saturation voltage vs. collector current Base-emitter saturation voltage vs. collector current

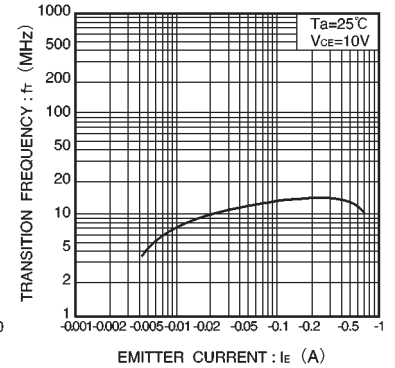

Fig.9 Gain bandwidth product vs. emitter current

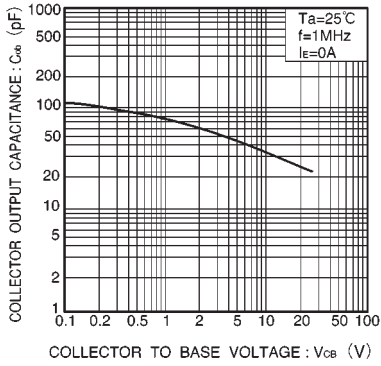

Fig.10 Collector output capacitance vs. collector-base voltage

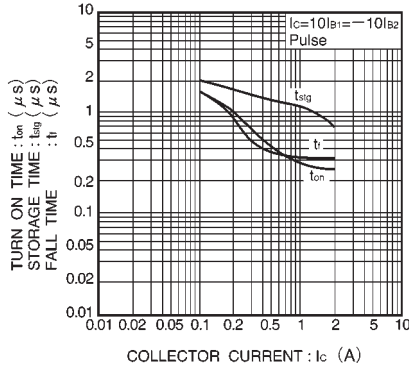

Fig.11 Switching time vs. collector current

● Switching characteristics measurement circuit

