

Thick film thermal printhead (8 dots / mm)

KF2008-GR10A

The KF2008-GR10A is a A4-size thick-film thermal printhead, developed mainly for plain-paper fax machines and portable printers. The KF2008-GR10A and the KF2008-GH10A are pin for pin compatible. This makes conversion of printers from thermal transfers to direct thermal easier.

●Applications

- Plain-paper facsimiles
- Portable printers
- Low speed ticket vendors
- Measuring terminal printers

●Features

- 1) A new pin connector structure greatly reduces the size and weight.
- 2) A newly developed 144-bit IC levels the strobe partition and reduces the noise level.
- 3) One rank resistance value of $3000\ \Omega \pm 3\%$ eliminates the inconvenience of rank selection.
- 4) Thick film type with glazed components provides good printing quality on rough paper.

●External dimensions (Units: mm)

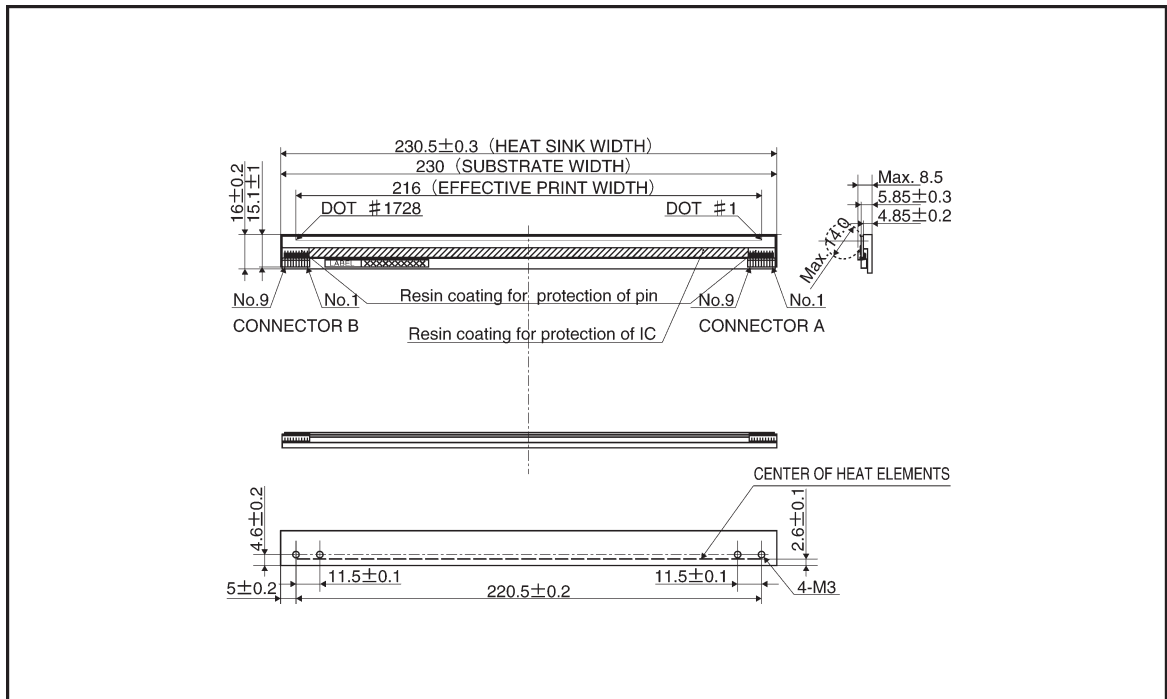

●Equivalent circuit

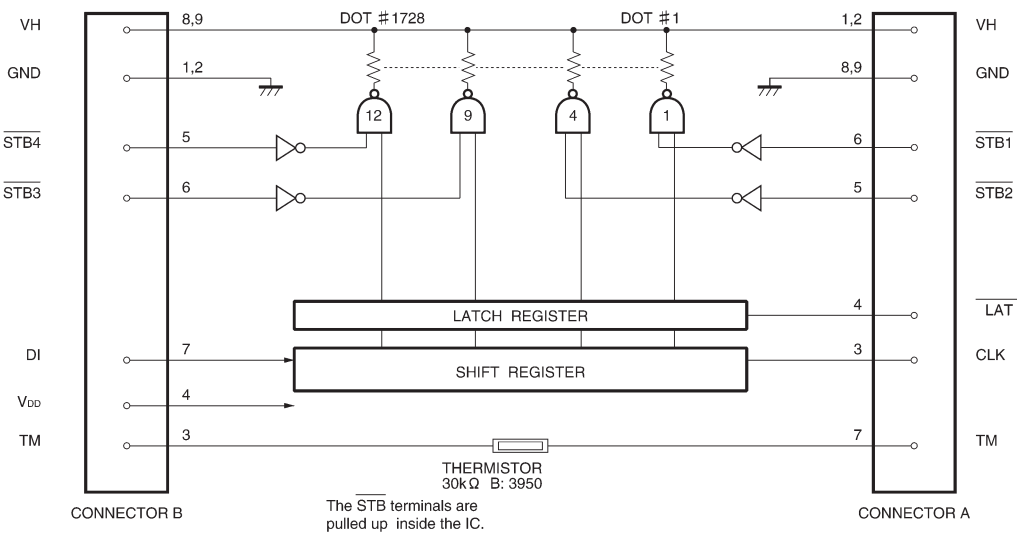

Fig. 1

●Pin assignments

CONNECTOR B	
No.	Circuit
1	GND
2	GND
3	TM
4	V _{DD}
5	STB4
6	STB3
7	DI
8	VH
9	VH

CONNECTOR A	
No.	Circuit
1	VH
2	VH
3	CLK
4	LAT
5	STB2
6	STB1
7	TM
8	GND
9	GND

●Timing chart

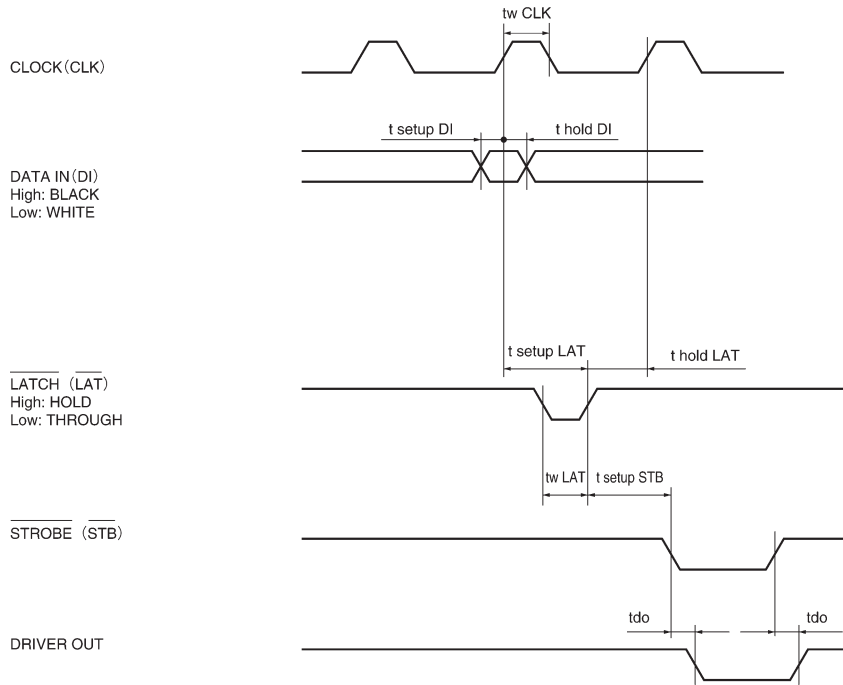

Fig.2

●Characteristics

Parameter	Symbol	Typical	Unit
Effective printing width	—	216.0	mm
Dot pitch	—	0.125	mm
Total dot number	—	1728	dots
Average resistance value	R _{ave}	3000	Ω
Applied voltage	V _H	24.0	V
Applied power	P _O	0.17	W / dot
Print cycle	SLT	10	ms
Pulse width	T _{ON}	1.95	ms
Maximum number of dots energized simultaneously	—	432	dots
Maximum clock frequency	—	4	MHz
Maximum roller diameter	—	14.0	mm
Running life / pulse life	—	20 / 3 × 10 ⁷	km / pulses
Operating temperature	—	5~45	°C

●Electrical characteristic curves

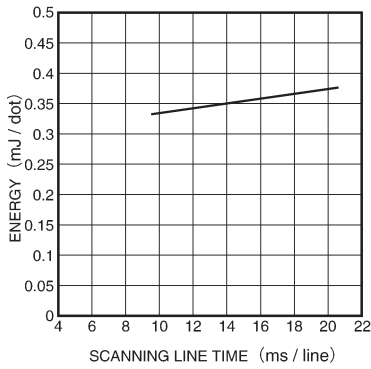

Fig. 3 Adaptive speed chart

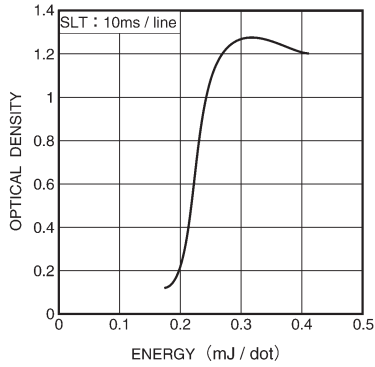

Fig. 4 Representative density curve

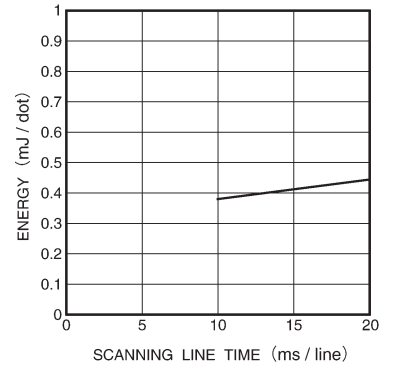

Fig. 5 Maximum energy curve

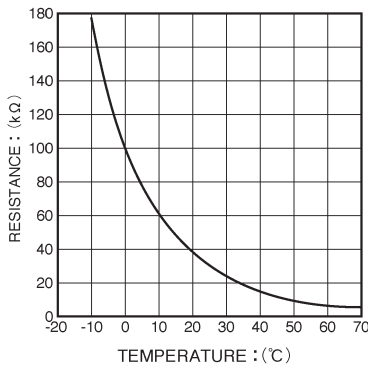

Fig. 6 Thermistor curve