

# Thick Film Thermal Printhead (300DPI)

## KF3003-GL50A

KF3003-GL50A is developing type of GL40 series which are developed mainly for label printers.

We have adopted low coefficient of abrasion and conductive protection coat to GL40 series which are possible for high speed and good printing quality.

That is KF3003-GL50A which is 24V standard thick film thermal print head with high speed, high quality of printing, high durability, long life, and strong resistance to abration.

### ●Applications

- High speed label printer
- Food label printer
- High speed ticket printer
- High speed terminal printer

### ●Features

- 1) Perform 150km life time adopting new protective coat.  
(Perform three times life time by coefficient of abrasion which is about 1/10 of current mass-producing coat.)
- 2) Build in thermal high speeded heater and perform high printing 6 IPS. (150mm / s)
- 3) Available for thermal transfer printing by adopting specific partial glaze.
- 4) Use the structure of thermal G-series which had good actual results. And these good results will guarantee high reliability of GL-series.
- 5) Line-up for 2 and 4 inches.

### ●External dimensions (Units : mm)

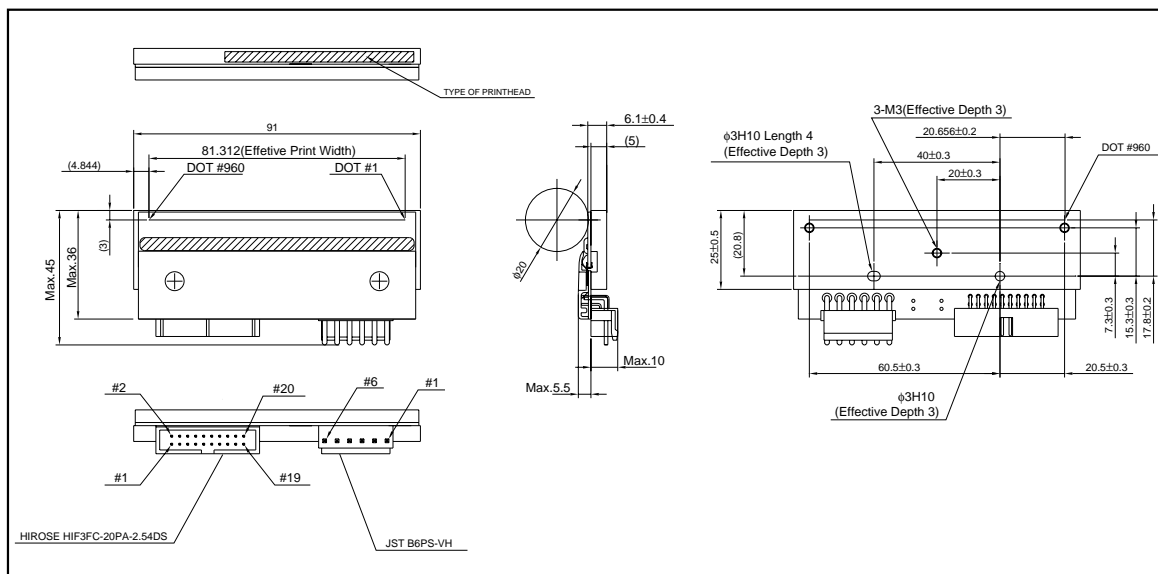

Printheads

●Equivalent circuit

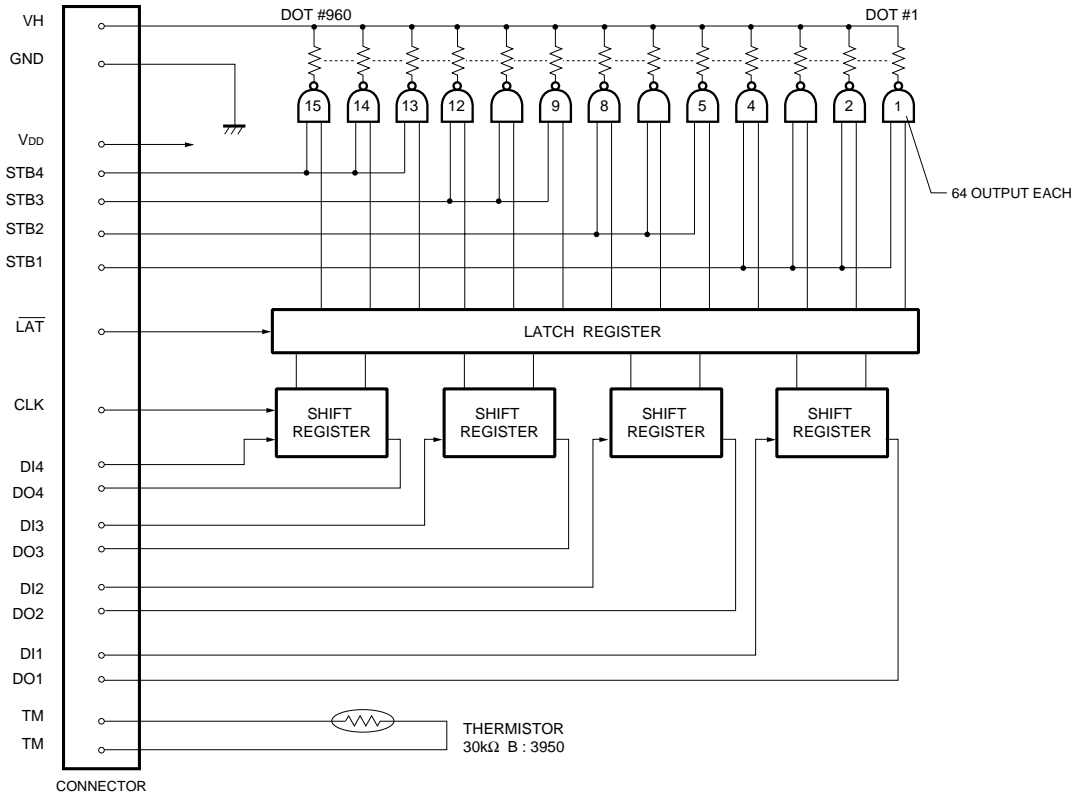

DI No.	DOT No.
DI1	1~256
DI2	257~512
DI3	513~768
DI4	769~960

STB No.	DOT No.
STB1	1~256
STB2	257~512
STB3	513~768
STB4	769~960

Fig. 1

●Pin configuration

CONNECTOR A			
No.	Circuit	No.	Circuit
1	GND	11	TM
2	V <sub>DD</sub>	12	TM
3	GND	13	DI3
4	V <sub>DD</sub>	14	DO3
5	STB4	15	DI2
6	CLK	16	DO2
7	DI4	17	STB2
8	DO4	18	STB1
9	STB3	19	DI1
10	LAT	20	DO1

CONNECTOR B	
No.	Circuit
1	VH
2	VH
3	VH
4	GND
5	GND
6	GND

Printheads

●Timing chart

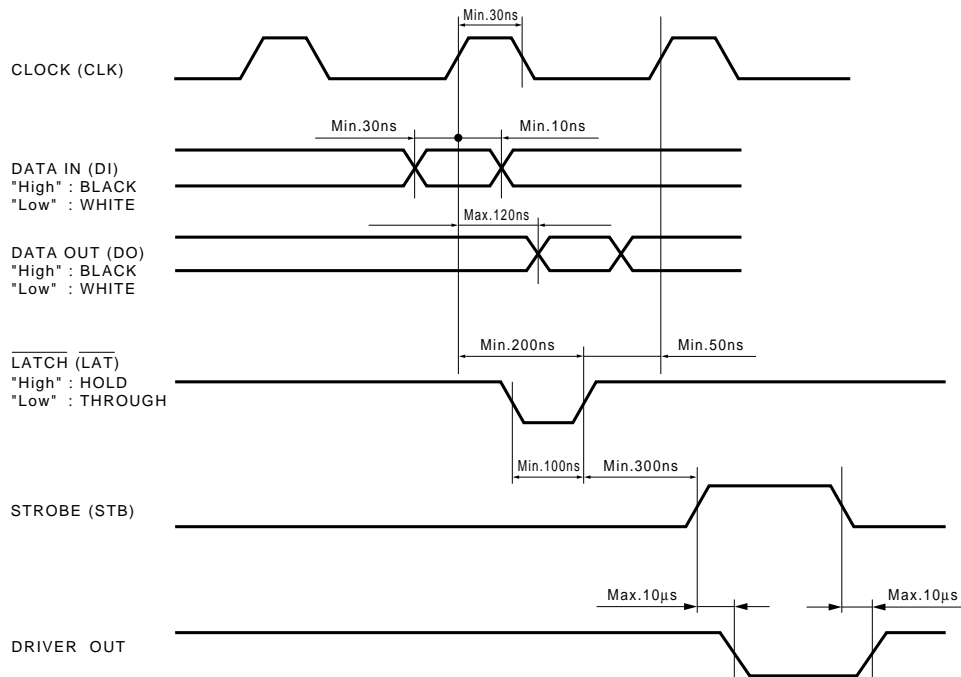

Fig.2

●Characteristics

Parameter	Symbol	Typ.	Unit
Effective printing width	-	81.31	mm
Dot pitch	-	0.0847	mm
Total dot number	-	960	dots
Average resistance value	Rave	1250	Ω
Applied voltage	V <sub>H</sub>	24	V
Applied power	P <sub>O</sub>	0.42	W / dot
Print cycle	SLT	0.83	ms
Pulse width	T <sub>ON</sub>	0.284	ms
Maximum number of dots energized simultaneously	-	960	dots
Maximum clock frequency	-	8	MHz
Maximum roller diameter	-	φ20.0	mm
Running life / pulse life	-	150 / 1×10 <sup>8</sup>	km / pulses
Operating temperature	-	5~45	°C

Printheads

●Data sheet

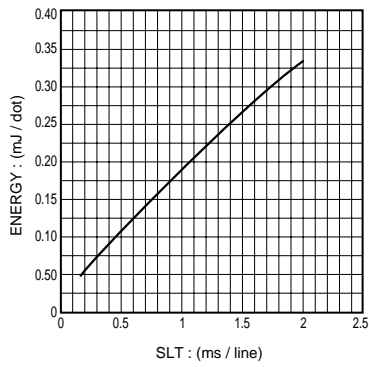

Fig.3 Maximum energy curve

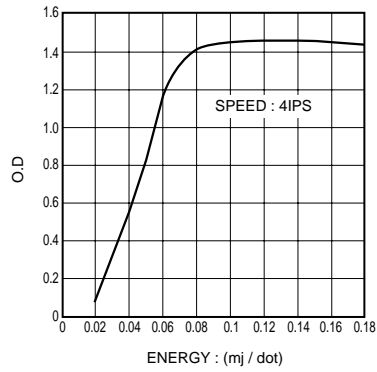

Fig.4 Representative density curve

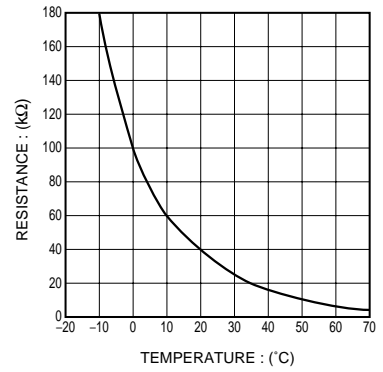

Fig.5 Thermistor curve