

16 x 16 dots transmissive large-sized liquid crystal display unit

RCM1277U-A

Thanks to the high contrast and wide viewing angle of the RCM1277U-A, which is provided by its unique design technology, this module brings forth new applications in brand new LCD fields. ROHM large-sized LCD units are perfect displays for information or sign boards. As a media for informational display, large-sized LCD units must possess high visibility, wide viewing angles, and other such superior qualities. ROHM large-sized LCDs boast an excellent track record and possess guaranteed functionality for assured satisfaction in a variety of situations.

●Applications

Public displays such as airport displays, train station displays, information boards, and billboards.

●Features

- 1) Wide viewing angle, high contrast, and fast response.
- 2) Compact and light weight for easy assembly.
- 3) Supports negative or positive display.
- 4) Low power consumption.

●External dimensions (Units : mm)

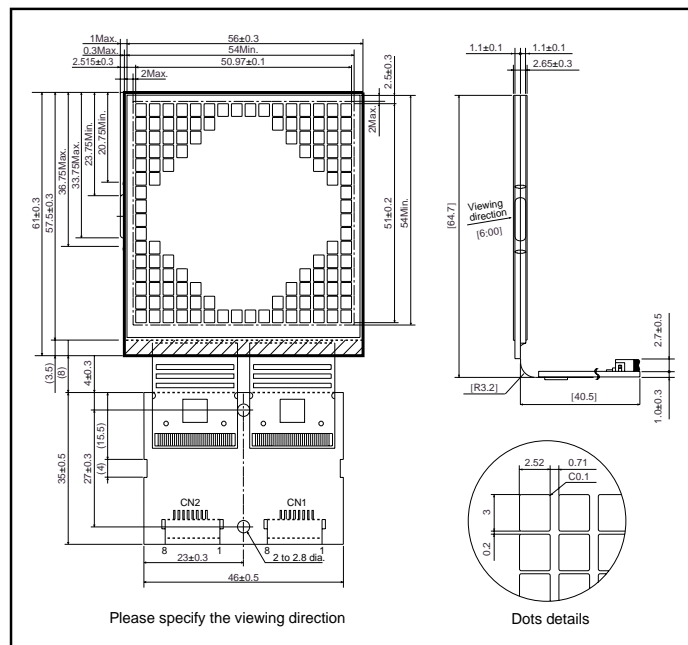

Liquid crystal displays

●Block diagram

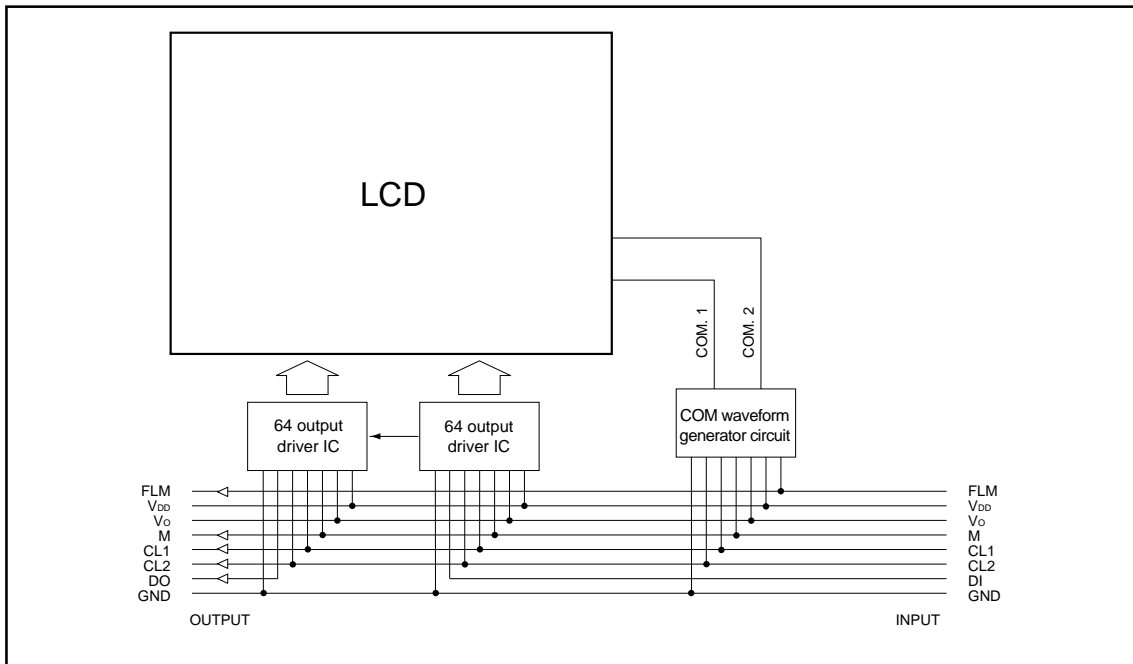

●Pin functions

(1) Input (CN1)

Pin no.	Symbol	IN / OUT	Function
1	FLM	IN	Frame start code
2	V ₀	-	Liquid crystal drive power supply
3	V _{DD}	-	Applies 5 V
4	M	IN	Liquid crystal drive output AC conversion signal
5	CL1	IN	Data latch signal (displays at rising edge)
6	CL2	IN	Shift register shift signal (reads data at falling edge)
7	DI	IN	Display data signal (1: On, 0: Off)
8	GND	-	Ground

(2) Output (CN2)

Pin no.	Symbol	IN / OUT	Function
1	GND	-	Ground
2	DO	OUT	Display data code
3	CL2	OUT	Shift lock signal
4	CL1	OUT	Data latch signal
5	M	OUT	AC conversion signal
6	V _{DD}	-	5 V
7	V ₀	-	Liquid crystal drive power supply
8	FLM	OUT	Frame start signal

Liquid crystal displays

● Absolute maximum ratings (Ta = 25°C)

Parameter	Symbol	Limics	Unit
Logic power supply voltage	V _{DD}	-0.3~+7.0	V
LCD drive voltage	V _{DD} -V _O	-0.3~+7.0	V
Input voltage	V _{IN}	-0.3~V _{DD} +0.3	V
Operating temperature	T _{opr}	0~+50	°C
Storage temperature	T _{stg}	-10~+60	°C

● Electrical characteristics (V_{DD} = 5.0V ± 0.25V, Ta = 25°C)

Parameter	Symbol	Min.	Typ.	Max.	Unit	Conditions
Input high level voltage	V _{IH}	3.5	-	-	V	
Input low level voltage	V _{IL}	-	-	1.5	V	
Output high level voltage	V _{OH}	4.6	-	-	V	-I _{OH} = -0.4mA
Output low level voltage	V _{OL}	-	-	0.4	V	I _{OL} = +0.4mA
Power supply current	I _{DD}	-	-	6.0	mA	f _{CL} = 1MHz, f _M = 70Hz

● AC characteristics (V_{DD} = 5.0V ± GND = 0V, Ta = 25°C)

Parameter	Symbol	Applicable terminal	Min.	Typ.	Max.	Unit
Shift frequency	f _{CL}	CL2	-	-	1	MHz
High level lock width	t _{cWH}	CL1, CL2	470	-	-	ns
Low level lock width	t _{cWL}	CL2	470	-	-	ns
Data setup time	t _{SU}	DI	120	-	-	ns
Clock setup time 1	t _{SL}	CL2	220	-	-	ns
Clock setup time 2	t _{LS}	CL1	220	-	-	ns
Data hold time	t _{DH}	DI	120	-	-	ns
Clock rise / fall time	t _{ci}	CL1, CL2	-	-	50	ns
FLM setup time	t _{FDS}	FLM	120	-	-	ns
FLM hold time	t _{FDH}	FLM	120	-	-	ns
Output delay time	t _{pd}	DO	-	-	250	ns
AC conversion signal	f _M	M	-	70	-	Hz

● Timing characteristics

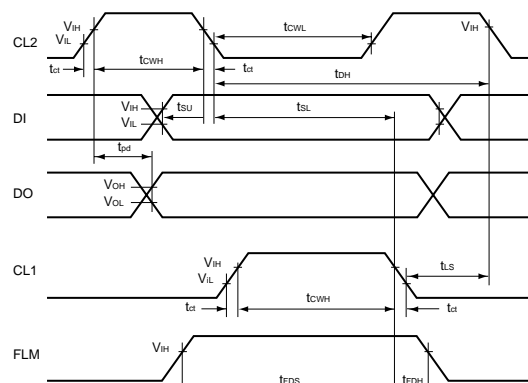

Fig.1

Liquid crystal displays

●Optical characteristics (Ta = 25°C)

NO.	Parameter	Symbol	Temperature (°C)	Min.	Typ.	Max.	Unit	Note
1	Response speed	Tr	25	-	65	130	ms	(Note 2)
		Td	25	-	45	100		
2	Viewing angle	Front-back	θ	25	0	-	deg	(Note 3) K≥3
		Right-left	φ	25	90	-		
3	Contrast ratio		25	20	-	-	-	(Note 4)

(Note 1) Drive waveform
Static drive

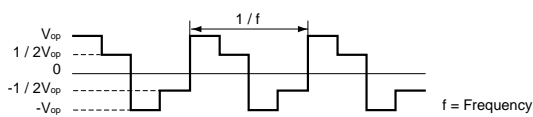

(Note 2) Definition of response speed

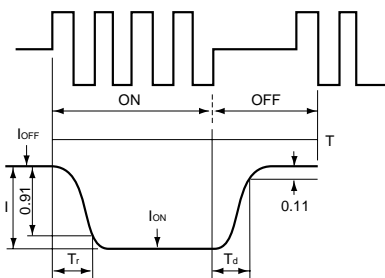

Tr : Time for segment to darken 90% after selective
Waveform switches to non-selective waveform.

$$\phi = 180^\circ, \theta = 10^\circ$$

Td : Time for segment to darken 90% after selective
Waveform switches to non-selective waveform.

$$\phi = 180^\circ, \theta = 10^\circ$$

(Note 3) Definition of viewing angle (φ, θ)

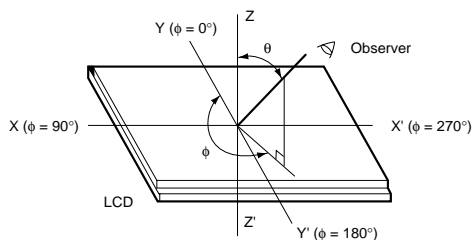

(1) φ : Angle subtended by the Y-Y'-axis and the
observer's position projected onto the XY-plane.

(2) θ : Angle subtended by observer and the normal
Z-Z'-axis (X-axis and Y-axis are positive)

(3) Maximum viewing angle: The direction with highest
contrast expressed at the time axis (refer to above
table).

(Note 4) Definition of contrast ratio
<Definition>

$$\text{Contrast ratio} = \left(\frac{\text{Luminance during application of non-selective waveform}}{\text{Luminance during application of selective waveform}} \right)^n$$

Except, $n = 1$ with positive display and $n = -1$ with
negative display.

<Measurement conditions>

Drive conditions: As per specifications

Viewing angle: $\phi = 180^\circ, \theta = 10^\circ$

(Note 5) Principles of optical measuring equipment

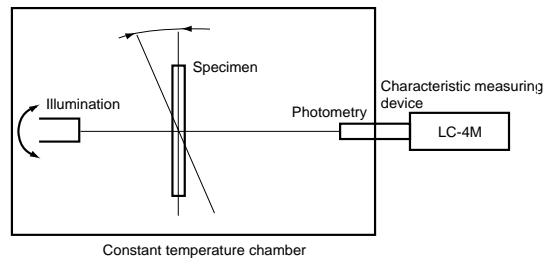

Liquid crystal displays

● Data format (data and display mapping)

D1	D17	D33	D49	D65	D81	-----	-----	-----	-----	-----	D193	D209	D225	D241	
D2	D18	D34	D50	D66	D82	-----	-----	-----	-----	-----	D194	D210	D226	D242	
D3	D19	D35	D51	D67	D83	-----	-----	-----	-----	-----	D195	D211	D227	D243	
D4	D20	D36	D52	D68	D84	-----	-----	-----	-----	-----	D196	D212	D228	D244	
D5											D197	D213	D229	D245	
D6														D246	
D7														D247	
D8														D248	
D9														D249	
D10														D250	
D11														D251	
D12											D188	D204	D220	D236	D252
D13	D29	D45	D61	D77	-----	-----	-----	-----	-----	D189	D205	D221	D237	D253	
D14	D30	D46	D62	D78	-----	-----	-----	-----	-----	D190	D206	D222	D238	D254	
D15	D31	D47	D63	D79	-----	-----	-----	-----	-----	D191	D207	D223	D239	D255	
D16	D32	D48	D64	D80	-----	-----	-----	-----	-----	D192	D208	D224	D240	D256	

FIRST DATA ←

D2	D4	D6	D8	-----	D252	D254	D256
----	----	----	----	-------	------	------	------

COM.2 DATA

D1	D3	D5	D7	-----	D251	D253	D255
----	----	----	----	-------	------	------	------

COM.1 DATA

→ LAST DATA

Liquid crystal displays

● Timing chart

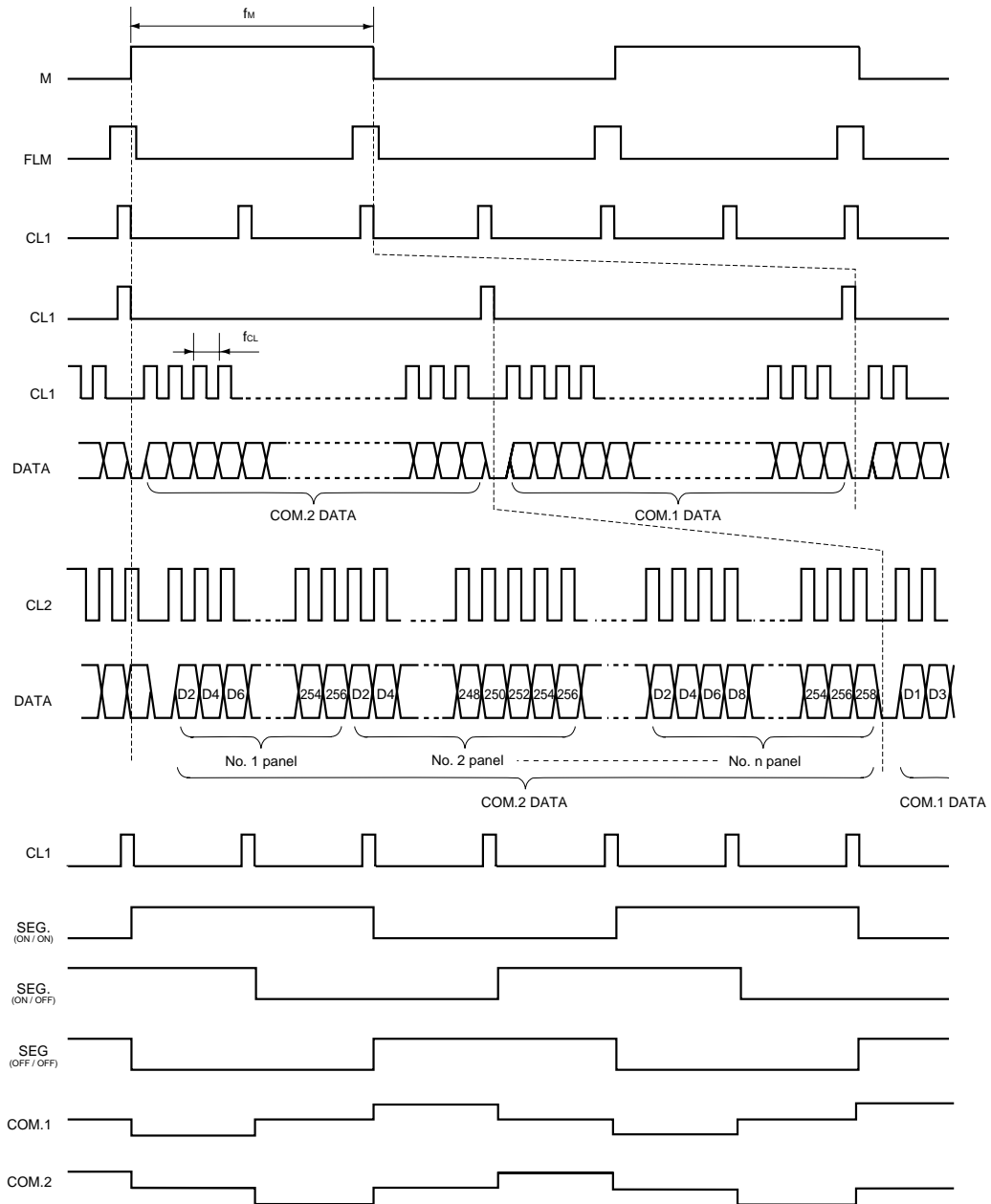

Liquid crystal displays

● Operation notes

(1) Attention points in handling

- Protect the module from strong shocks as they can cause damage or defective operation.
- The polarizing plate on the surface of the module is soft and can easily be scratched. Wipe away dirt and dust using an alcohol-based cleanser.
- If the liquid crystal panel is damaged and liquid crystal contacts your clothing or body, wash immediately with soap and water.
- Do not touch the IC lead electrodes or the electrode terminal components.
- If the module is to be used for long periods subjected to direct sunlight, employ a filter to block the ultraviolet rays.
- Do not store the module in areas of high temperature or high humidity. Do not store the module in locations exposed to direct sunlight or fluorescent light.
- During handling of the module, in order to prevent damage to the tab, do not bend it more than two times.

(2) Precautions during operation

- Do not connect or disconnect the module while the power supply is turned on.
- Input the input signal after the module power supply is turned on. When turning it off, turn off the input signal first. Otherwise the IC may be damaged by the latch-up phenomenon.

(3) Precautions during installation

- Be careful to avoid damage from static electricity. A CMOS-IC is used in the modules circuitry that can be easily damaged by static electricity.
- A protective film is pasted over the front and back of the module to protect the panel surfaces. When peeling this film off, be sure to peel as slow as possible in order to minimize the generation of static electricity. Use of an ion blower or other deionizing device is recommended.