

Photointerrupter, double-layer mold type

RPI-222

The RPI-222 is an ultra-small size, double-layer mold photointerrupter.

●Applications

Optical control equipment
Cameras
Floppy disk drives
Digital video disc

●Features

- 1) Ultra-small.
- 2) Minimal influence from stray light.
- 3) Low collector-emitter saturation voltage.

●External dimensions (Units: mm)

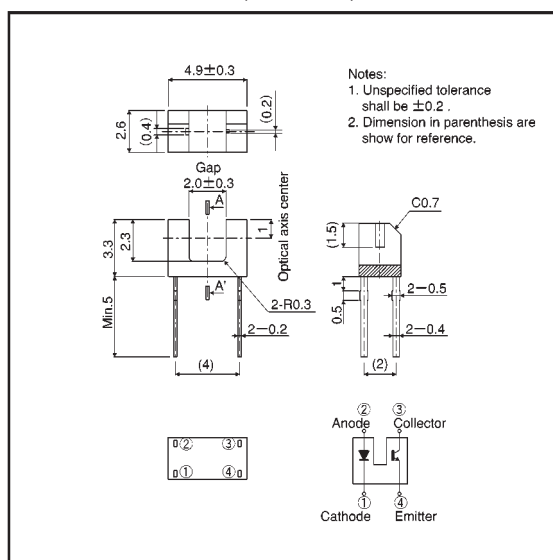

●Absolute maximum ratings

Parameter		Symbol	Limits	Unit
Input(LED)	Forward current	I_F	50	mA
	Reverse voltage	V_R	5	V
	Power dissipation	P_D	80	mW
Output (photo-transistor)	Collector-emitter voltage	V_{CEO}	30	V
	Emitter-collector voltage	V_{ECO}	4.5	V
	Collector current	I_C	30	mA
	Collector power dissipation	P_C	80	mW
Operating temperature		T_{opr}	$-25 \sim +85$	$^{\circ}\text{C}$
Storage temperature		T_{stg}	$-30 \sim +85$	$^{\circ}\text{C}$

● Electrical and optical characteristics (Tc = 25°C)

Parameter		Symbol	Min.	Typ.	Max.	Unit	Conditions
Input characteristics	Forward voltage	V_F	—	1.3	1.6	V	$I_F=50\text{mA}$
	Reverse current	I_R	—	—	10	μA	$V_R=5\text{V}$
Output characteristics	Dark current	I_{CEO}	—	—	0.5	μA	$V_{CE}=10\text{V}$
	Peak sensitivity wavelength	λ_P	—	800	—	nm	—
Transfer characteristics	Collector current	I_C	0.18	0.3	0.95	mA	$V_{CE}=5\text{V}, I_F=10\text{mA}$
	Collector-emitter saturation voltage	$V_{CE(sat)}$	—	—	0.4	V	$I_F=20\text{mA}, I_C=0.1\text{mA}$
	Response time	$t_r \cdot t_f$	—	10	—	μs	$V_{CC}=5\text{V}, I_F=20\text{mA}, R_L=100\Omega$

● Electrical and optical characteristic curves

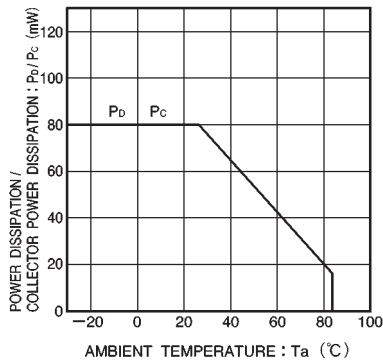

Fig.1 Power dissipation / collector power dissipation vs. ambient temperature

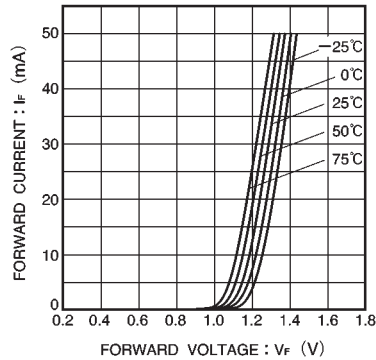

Fig.2 Forward current vs. forward voltage

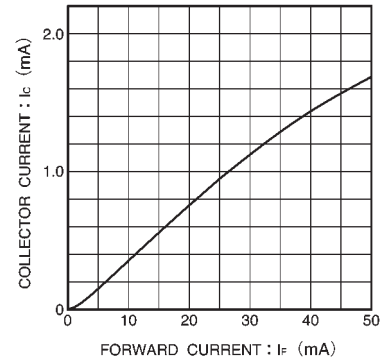

Fig.3 Collector current vs. forward current

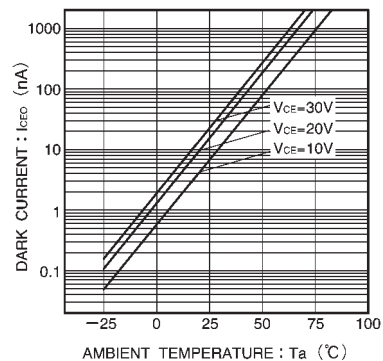

Fig.4 Dark current vs. ambient temperature

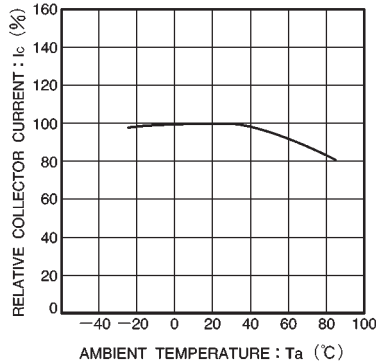

Fig.5 Relative output vs. ambient temperature

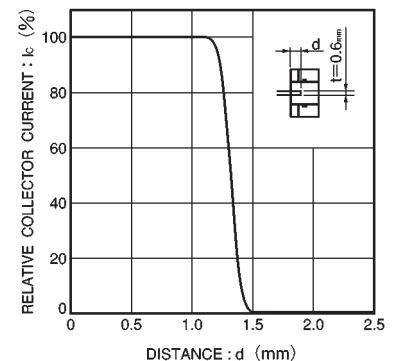

Fig.6 Relative output current vs. distance (1)

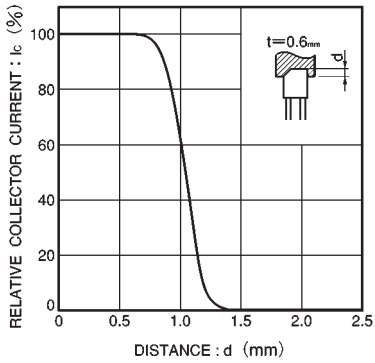

Fig.7 Relative output current vs. distance (II)

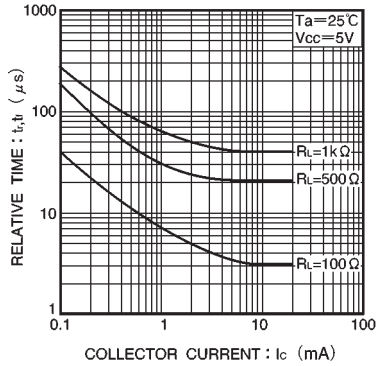

Fig.8 Response time vs. output current

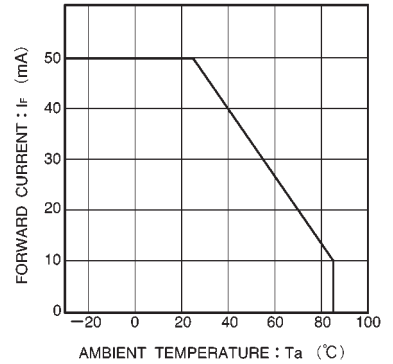

Fig.9 Forward current falloff

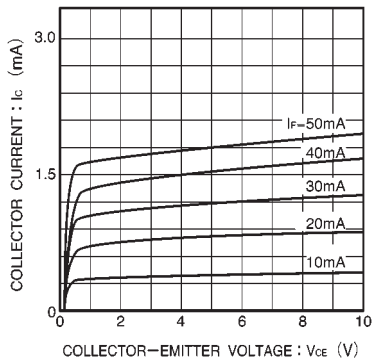

Fig.10 Output characteristics

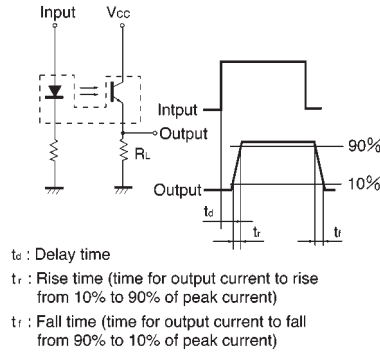

Fig.11 Response time measurement circuit