

Video signal switcher

BA7021

The BA7021 is a switching IC developed for use in VCRs and televisions. It contains a three-channel analog multiplexer, a built-in mute, and video clamp.

●Applications

Video cassette recorders, televisions and video disc players

●Features

- 1) 3-input / 1-output.
- 2) Built-in video clamp circuit.
- 3) Built-in mute circuit.
- 4) Operates of a 5V (Typ.) power supply and has low power consumption.

●Block diagram

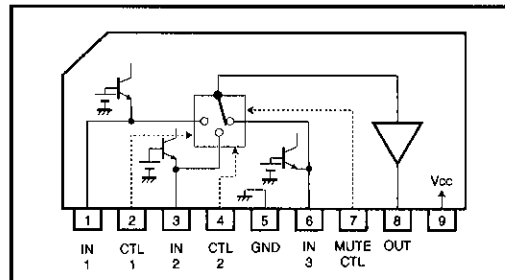

●Absolute maximum ratings (Ta=25°C)

Parameter	Symbol	Limits	Unit
Power supply voltage	V _{cc}	10	V
Power dissipation	P _d	950 *	mW
Operating temperature	T _{opr}	-25~60	°C
Storage temperature	T _{stg}	-55~125	°C

* Reduced by 9.5mW for each increase in Ta of 1°C over 25°C.

●Electrical characteristics (Unless otherwise specified Ta=25°C and V_{cc}=5.0V)

Parameter	Symbol	Min.	Typ.	Max.	Unit	Conditions
Operating voltage	V _{cc}	4.5	5.0	6.0	V	—
Quiescent current	I _q	—	5.0	8.0	mA	—
Maximum output level	V _{OM}	1.9	2.7	—	V _{P-P}	Switch operation 1
Voltage gain	G _v	-0.5	0.0	+0.5	dB	f=1MHz, V _{IN} =2V _{P-P} , Switch operation 1
Interchannel crosstalk	C _T	—	-55	-45	dB	f=4.43MHz, V _{IN} =2V _{P-P} , Switch operation 2
Mute function	C _{TM}	—	-50	-40	dB	f=4.43MHz, V _{IN} =2V _{P-P} , Switch operation 3
Frequency characteristic	ΔG _v	-0.5	0.0	+0.5	dB	f=4.43MHz / 1MHz, V _{IN} =2V _{P-P} , Switch operation 1
CTL pin switch level	V _{TH}	0.1	0.7	2.0	V	2pin, 4pin, 7pin

● Measurement circuit

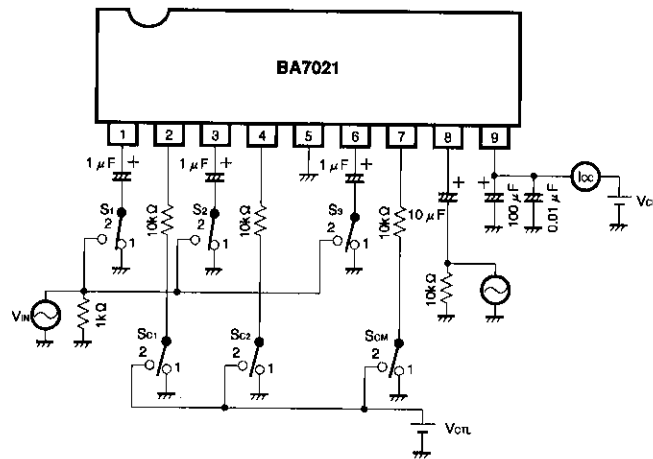
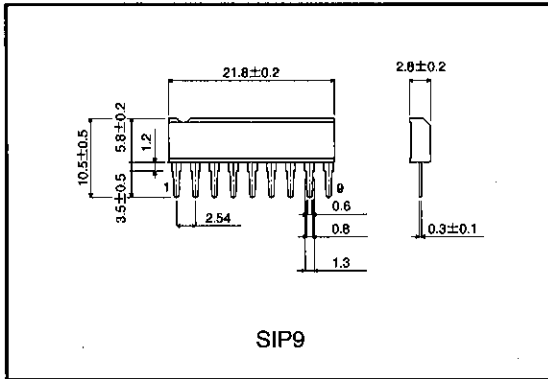

Fig.1

● Switch table

Measurement parameter	Input mode	S ₁	S ₂	S ₃	Sc ₁	Sc ₂	Sc _M	Remarks	
1	Input/output characteristic								
	1pin	2	1	1	2	1	1	1pin→8pin	
	3pin	1	2	1	1	2	1	3pin→8pin	
	6pin	1	1	2	1	1	1	6pin→8pin	
2	Crosstalk	1pin	2	1	2	1	1	Input from pin 3	
			1	2				Input from pin 6	
		3pin	2	1	1	2	1	Input from pin 1	
			1	2				Input from pin 6	
		6pin	2	1	1	1	1	Input from pin 1	
			1	2				Input from pin 3	
3	Muting	1pin	2	1	1	2	2		
		3pin	1	2	1	1	2	2	
		6pin	1	1	2	1	1	2	

●External dimensions (Units: mm)



Video signal selection switches

AV switches