

SANYO

No.3248C

LA2805,2805M

Telephone Answering Machine Use

Overview

The LA2805,2805M is a telephone answering machine-use bipolar IC that performs the basic functions required for telephone answering machine and has the microcomputer interfaces and analog switches to control these functions.

The LA2805,2805M is applicable to telephone answering machines of both 2-mechanism and 1-mechanism types and available in compact DIP-24S and MFP-24D packages.

Functions

- 1) Preamp for recording/playback (with ALC)
- 2) Recording amp (DC bias)
- 3) Analog switches
- 4) Voice detector (VOX)
- 5) Zero-cross comparator for beep tone detection
- 6) Power amp ($P_o = 300\text{mW}$, $R_L = 8\Omega$, $V_{CC} = 9\text{V}$)
- 7) Line amp
- 8) Microcomputer interface

Features

- Since the LA2805,2805M contains all the functions required for telephone answering machine and can be controlled by a microcomputer, a unique system can be made up.
- The recording amp gain and recording bias current can be set independently by an external resistor.
- Low distortion
- Compact package (DIP-24S, MFP-24D)

Maximum Ratings at $T_a = 25^\circ\text{C}$

			unit
Maximum Supply Voltage	V_{CC} max	14	V
Maximum Supply Voltage	$P.V_{CC}$ max	14	V
Allowable Power Dissipation	P_d max	1.26	W
Control Signal Input Voltage	VID	-0.3 to +4.2	V
Operating Temperature	T_{opr}	-20 to +70	$^\circ\text{C}$
Storage Temperature	T_{stg}	-40 to +150	$^\circ\text{C}$

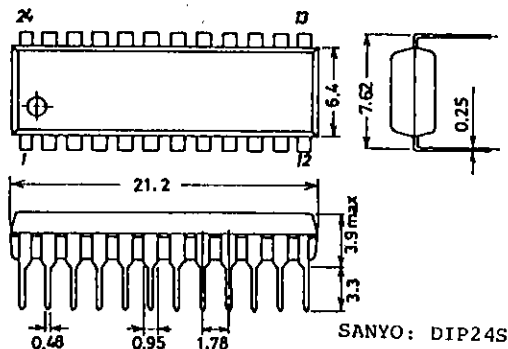
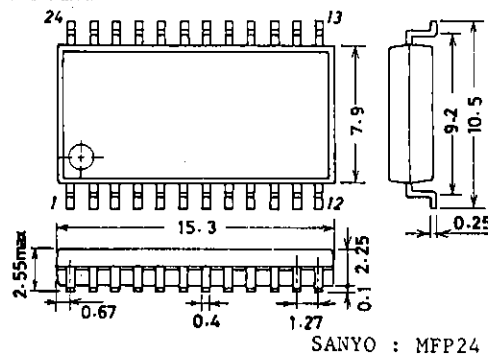
Package Dimensions 3067
(unit: mm)**Package Dimensions 3108**
(unit: mm)

LA2805,2805M

Operating Conditions at Ta = 25°C				unit		
Recommended Supply Voltage	V _{CC}		9	V		
Recommended Supply Voltage	P.V _{CC}		9	V		
Operating Voltage Range	V _{CC op}		7 to 12	V		
Operating Voltage Range	P.V _{CC op}		7 to 12	V		
Load Resistance	R _L	Power amp	8	Ω		
Control Signal 'H'-Level	V _{IH1}	Pins D ₀ ,D ₁	3.5 to 4.2	V		
Input Voltage			(or open)			
Control Signal 'M'-Level	V _{IM1}	Pins D ₀ ,D ₁	2.0 to 2.8	V		
Input Voltage			(or grounded through 100kΩ)			
Control Signal 'L'-Level	V _{IL1}	Pins D ₀ ,D ₁	0 to 0.8	V		
Input Voltage						
Control Signal 'H'-Level	V _{IH2}	Pins D ₂ ,MUTE	2.0 to 4.2	V		
Input Voltage			(or open:D ₂)			
Control Signal 'L'-Level	V _{IL2}	Pins D ₂ ,MUTE	0 to 0.8	V		
Input Voltage						
Preamp Input Signal Voltage	V _{IN}		0 to 1.0	V _{p-p}		
Operating Characteristics at Ta = 25°C, V_{CC}, P.V_{CC} = 9V, f = 1kHz						
			min	typ	max	unit
Quiescent Current	I _{CC1}	V _{CC}		12	18	mA
Quiescent Current	I _{CC2}	P.V _{CC}		20	30	mA
[Preamp]						
Voltage Gain	V _{GC}	-70dBs input : ICM REC	47	49	51	dB
Total Harmonic Distortion	THD	-40dBs input		0.5	1.0	%
ALC Turn Point	V _{ALC}		-58	-54	-50	dBs
ALC Saturation Output Level	V _{OS}	-40dBs input	400	500	625	mVrms
Equivalent Input	V _{NI}	Input short (2.2kΩ contained), flat			50	μVrms
Noise Voltage						
ALC Range	ALC W	From ALC ON until THD = 1%	40	45		dB
[REC amp]						
Voltage Gain	V _{GR}	Between pins 10 and 4, : ICM REC ZAC = 25kΩ	-7.0	-4.0	-1.0	dB
Output Bias Voltage	V _B	ZDC = 50kΩ	0.8	1.3	1.7	V
Total Harmonic Distortion	THD	Preamp input - 40dBs		0.5	1.0	%
[Line amp] at R _L = 1kΩ						
Voltage Gain	V _{GL}	Between pins 10 and 17, : OGMOUT	8	9.3	11	dB
Total Harmonic Distortion	THD	Preamp input - 40dBs		0.5	1.0	%
Maximum Output Voltage	V _{O max}	THD = 1%	1.8			Vrms
[Power amp] at R _L = 8Ω, input pin 13						
Voltage Gain	V _{GP}	-20dBs input : ICM REC	20	22	24	dB
Output Power	P _o	THD = 10%	0.2	0.3		W
Total Harmonic Distortion	THD	P _o = 0.15W		0.5	1.0	%
Input Resistance	r _i		7	10	13	kΩ
Ripple Rejection	SVRR	R _g = 0, f _r = 100Hz, V _{ccr} = -20dBs	38	41		dB
Output Noise Voltage	V _{NO}	Input short, flat		0.3	0.5	mVrms
[Beep tone detector] 5V applied to pin 21 through R = 20kΩ						
Output Signal Duty Ratio	D-R	Pin 10 input - 22dBs	40	50	60	%
Output Terminal	V _{sat}				0.4	V
ON-State Voltage						
[VOX] 5V applied to pin 20 through R = 20kΩ						
Sensitivity	V _{OXL}	Pin 10 input - 24dBs			0.3	V
	V _{OXH}	Pin 10 input - 28dBs	4		5	V
Output Terminal	V _{sat}				0.3	V
On-State Voltage						
[VRFF]						
Output Voltage	V _{ref}		3.6	3.8	4.0	V

Description of Equivalent Circuit Block Diagram

- 1) D_0 to D_2 (pins 24 to 22)
Each pin can be driven by the microcomputer output.
- 2) VREF
Provides V_{ref} (pin 11) of approximately 3.8V.
- 3) Preamp
Amplifies the input signal at pins 3 to 6.
- 4) ALC
The ALC operates in the input range of -54dB s to approximately -10dB s. The ALC saturation output level is 500mV_{rms} .
- 5) MUTE
Mutes the preamp output and power amp input. When pin 19 is at "H" level, the SW10 and SW11 open and VOX output (pin 20) is at "L" level.
- 6) REC Amp
Amp used for recording.
- 7) V/I Recording Current
V/I conversion is made to draw the recording current for DC bias. The conversion gain and bias current can be changed arbitrarily by external resistors connected to pin 1.
- 8) Line Amp
Buffer amp for line output.
- 9) Beep Tone DET
A microcomputer is used to identify the beep tone signal or remote control signal included in the pin 21 output. Zero-cross comparator for pin 10 input signal.
- 10) VOX
Detects the presence or absence of a call. Pin 10 input signal (V_{10}) level detection.
 $V_{10} \geq -24\text{dB}$ s Pin 20 "L"
- 11) Power Amp
 $P_o = 300\text{mW}$ (typ) at $P.V_{CC} = 9\text{V}, R_L = 8\Omega$

Mode Description

- 1) ICM REC (Incoming Message Rec.)
 - Incoming message recording.
 - Recording of dictation sent from the place where you have gone (remote-controlled from the place where you have gone).
- 2) 2-WAY REC
 - Recording of both conversations while talking over the telephone.
 - Incoming message recording.
- 3) DICT REC
 - MIC-used dictation recording (recording of message to family or brief message contents).
- 4) 2-WAY BEEP
 - Speaker-output of alarm sound and incoming message recording and also line-output to your calling party.
 - Your calling party is made known that the incoming message is being recorded.
 - Line-output is down 6dB from line-output at other mode.
- 5) ICM OUT
 - Incoming message playback.
 - Listening to the incoming message through the telephone installed in the place where you have gone.
 - Incoming message line-out.
 - Recorded dictation playback.

Continued on next page.

Continued from preceding page.

- 6) ICM PLAY
 - Incoming message playback.
 - Recorded dictation playback.
- 7) OGM REC I (Outgoing Message Rec. I)
 - Outgoing message recording (tape).
- 8) OGM Change
 - Change outgoing message by remote control from the place where you have gone.
- 9) OGM REC II
 - Outgoing message recording (IC).
- 10) OGM OUT
 - Outgoing message playback.
 - Outgoing message line-output (at remote control operation mode, etc.).
- 11) OGM PLAY
 - Outgoing message playback and check.
- 12) Beep REC
 - BEEP signal recording before and after outgoing message.
- 13) ROOM MONI
 - Listening to the MIC-used input by remote control from the place where you have gone.

Sample Application Circuit

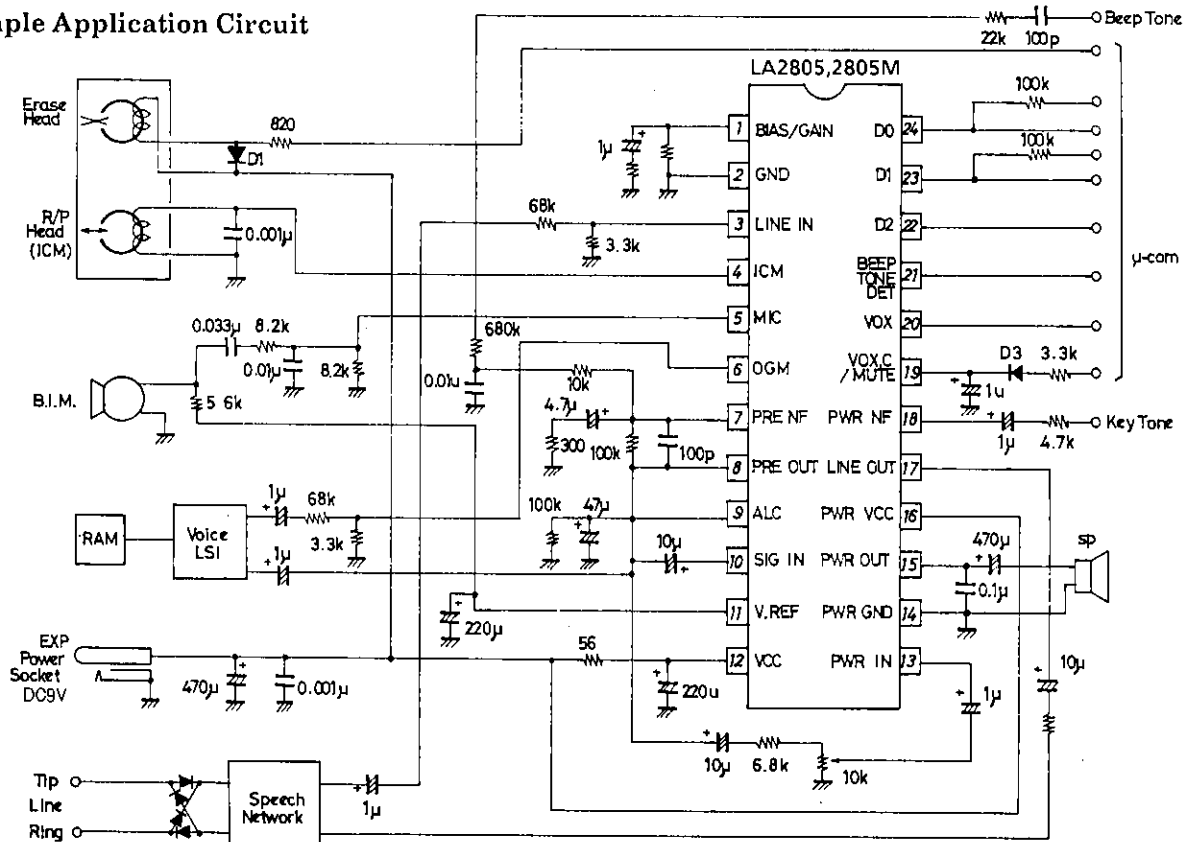

Unit (resistance: Ω, capacitance: F)

Proper Cares in Using IC

1. Printed Circuit Board

When designing the printed circuit board, make the ground line at pin 2 thicker and shorter. Especially, it should be noted that if a common impedance exists in the ground, the distortion may worsen.

2. Power Amplifier

For the oscillation preventing capacitor connected across output pin 15 and ground, it is recommended to use a polyester film capacitor which is excellent in temperature characteristic and frequency characteristic. The use of an aluminum electrolytic capacitor or ceramic capacitor may cause oscillation to occur at low temperature.

3. Shock Noise

The shock noise which occurs from the preamplifier at the time of input selection can be masked by applying MUTE signal to pin 19. It is recommended that 3 msec or greater of MUTE signal pulse width.

4. Control Input Circuit

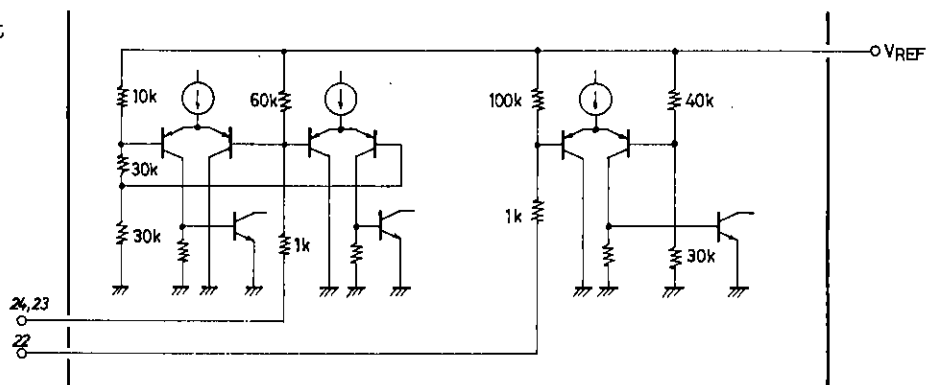

Unit (resistance: Ω)

Input circuit of control pins (22, 23, 24) is shown above.

Tri-state input pins (23, 24) selection level $V_{CONT1,2}$:

$$V_{CONT1} = V_{REF} \times \frac{6}{7} [V], \quad V_{CONT2} = V_{REF} \times \frac{3}{7} [V]$$

5. Maximum Rating

If the IC is used in the vicinity of the maximum rating, even a slight variation in conditions may cause the maximum rating to be exceeded, thereby leading to a breakdown. Allow an ample margin of variation for supply voltage, etc. and use the IC in the range where the maximum rating is not exceeded.

6. Short between Pins

If the supply voltage is applied when the space between pins is shorted, a breakdown or deterioration may occur. When installing the IC on the board or applying the supply voltage, make sure that the space between pins is not shorted with solder, etc.

7. Load Short

If the IC is used with the load shorted for a long time, a breakdown or deterioration may occur. Be sure not to short the load.

LA2805,2805M

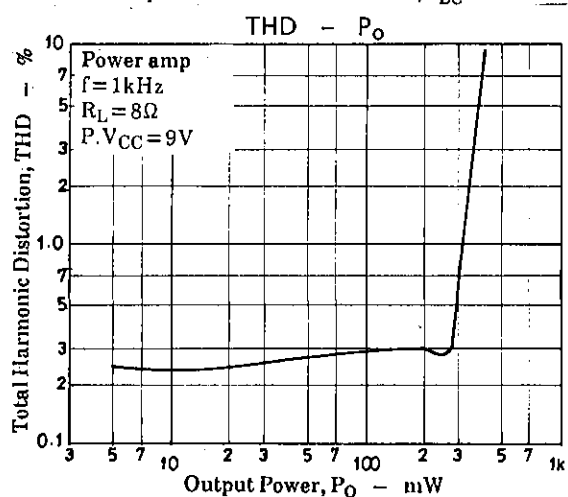
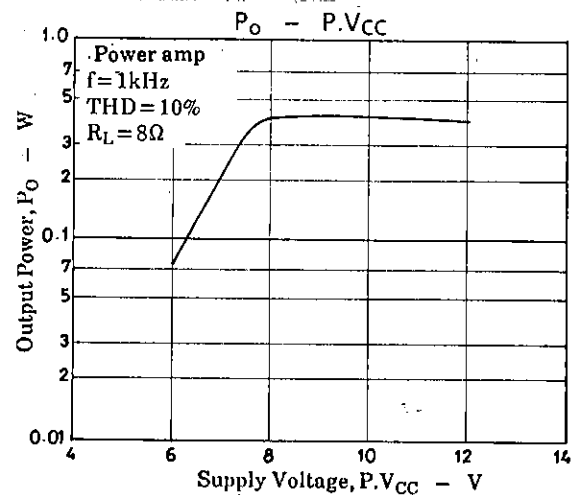
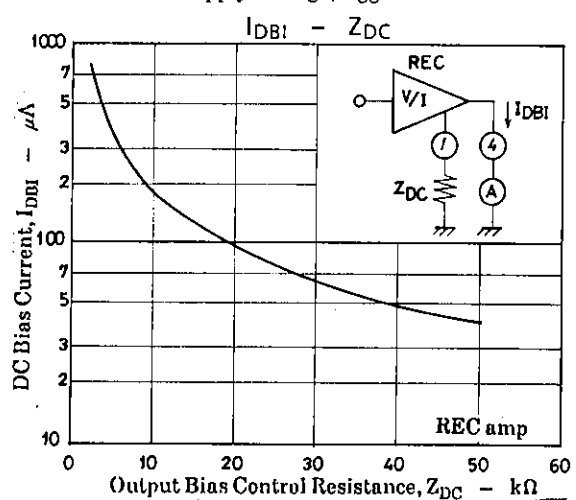
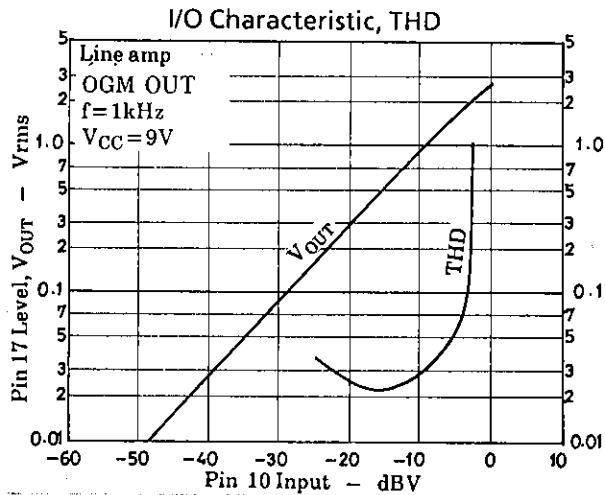
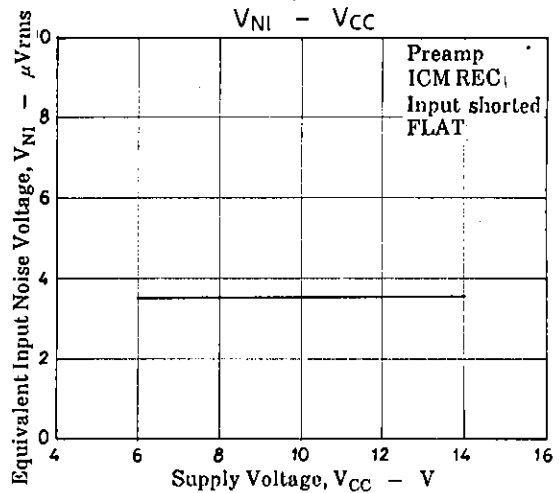
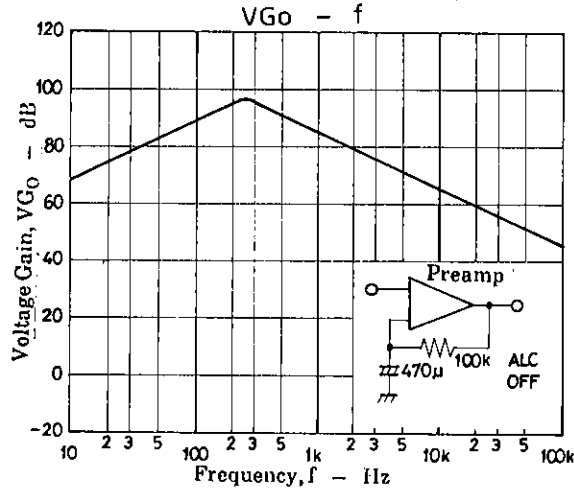
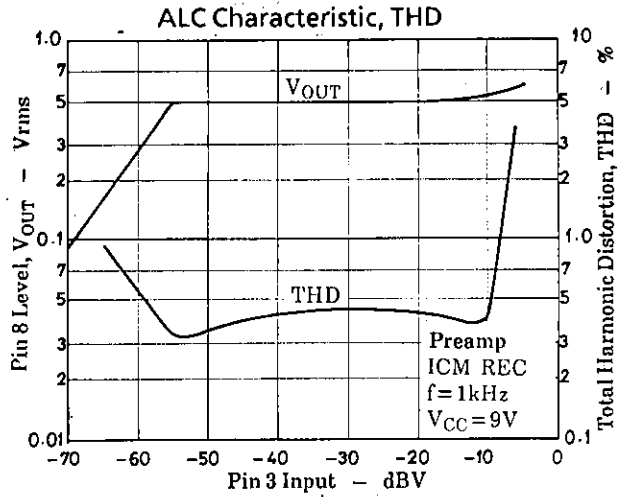
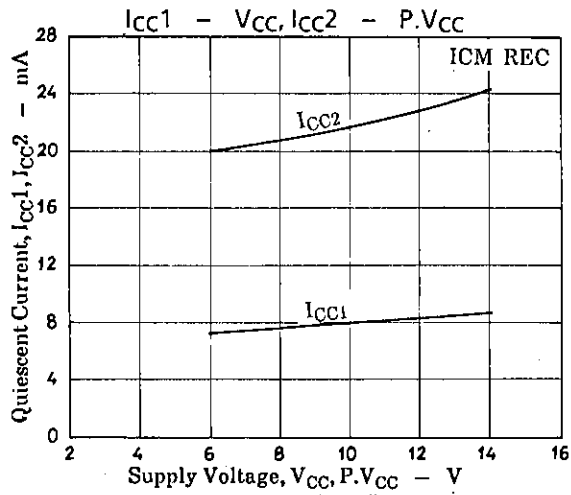

LA2805,2805M

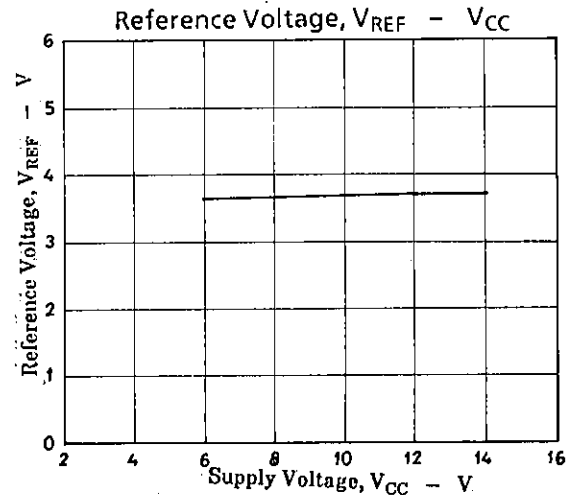
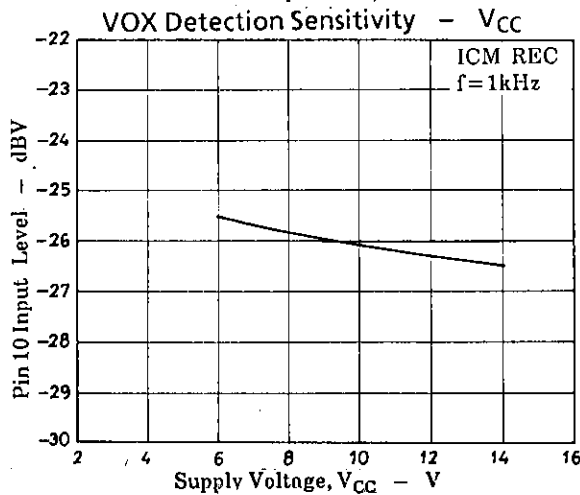
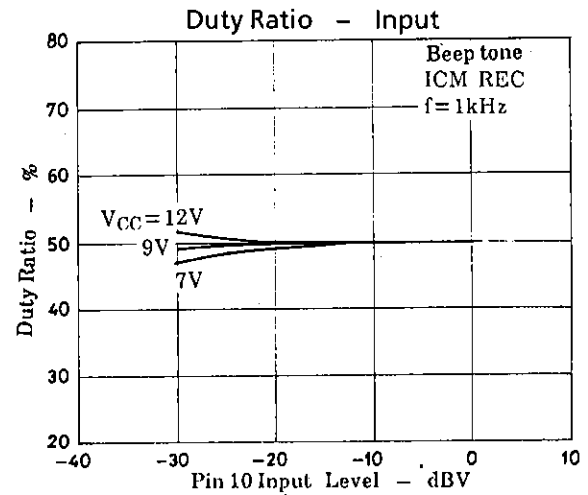
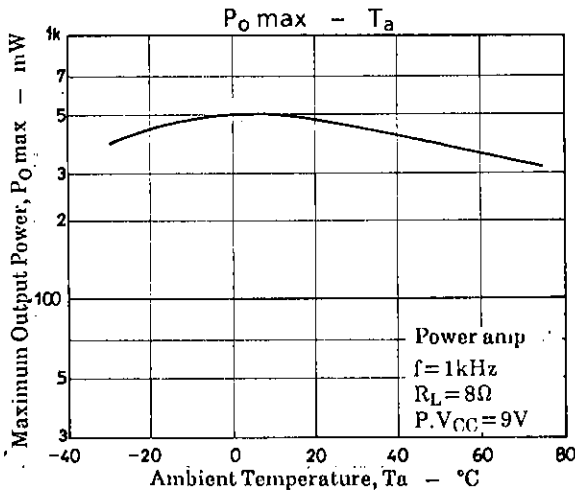
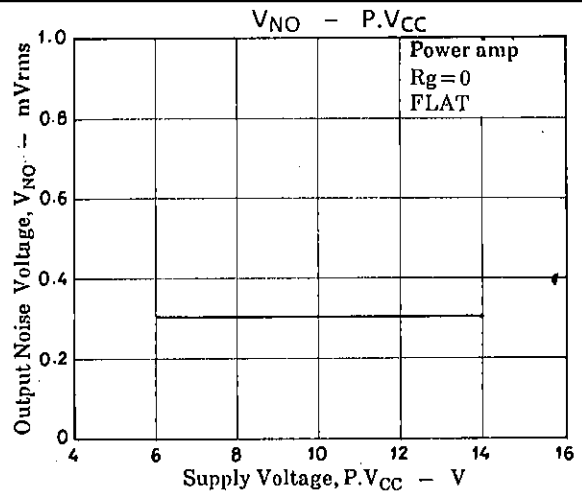
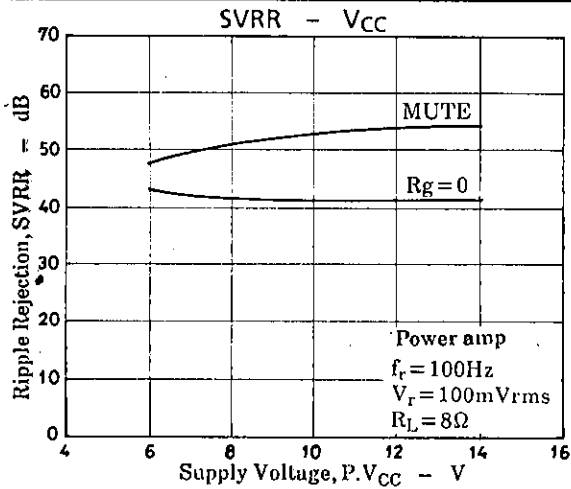

- No products described or contained herein are intended for use in surgical implants, life-support systems, aerospace equipment, nuclear power control systems, vehicles, disaster/crime-prevention equipment and the like, the failure of which may directly or indirectly cause injury, death or property loss.
- Anyone purchasing any products described or contained herein for an above-mentioned use shall:
 - ① Accept full responsibility and indemnify and defend SANYO ELECTRIC CO., LTD., its affiliates, subsidiaries and distributors and all their officers and employees, jointly and severally, against any and all claims and litigation and all damages, cost and expenses associated with such use;
 - ② Not impose any responsibility for any fault or negligence which may be cited in any such claim or litigation on SANYO ELECTRIC CO., LTD., its affiliates, subsidiaries and distributors or any of their officers and employees jointly or severally.
- Information (including circuit diagrams and circuit parameters) herein is for example only; it is not guaranteed for volume production. SANYO believes information herein is accurate and reliable, but no guarantees are made or implied regarding its use or any infringements of intellectual property rights or other rights of third parties.